

The New Stereo Phonograph Cartridges

SEPTEMBER 1958

Radio-Electronics

TELEVISION • SERVICING • HIGH FIDELITY

HUGO GERNSBACK, Editor

Five European
Hi-Fi Amplifiers

■

You Can Watch
Transatlantic TV

■

Electronic
Wind Meter

■

"Subber" Checks
Sync Circuits

New Design Ideas in
Horn Type Enclosure

(See page 42)



35c

U.S. and Canada

For all your hi-fi listening... **Jensen** presents these new Stereo Director* Systems with challenging performance... in high fashion furniture... at prices that set new standards for loudspeaker values.



JENSEN DS-100 DUAL 3-WAY SYSTEM WITH THE NEW

Jensen
STEREO DIRECTOR*

The DS-100 dual stereo unit, in the popular lowboy, is the answer to the buyer's demand for a complete stereo reproducer in one cabinet. This handsomely styled loudspeaker system provides two completely independent 3-way speaker systems with 12" Flexair woofers (total of 6 speakers) which can be used together for superior spread source monophonic sound, as well as stereo. The two Stereo Directors, each having an 8 inch mid-channel and compression driver h-f unit, allow flexibility in cabinet placement with maximum effectiveness in aiming the sound to the favored listening area. Crossover frequencies 600 and 4000 cycles. 32" H., 52" W., 18 1/4" D. Available in Walnut, Tawny Ash and Mahogany
Net Price.....369.50

HOW THE NEW JENSEN STEREO DIRECTOR WORKS...

A pair of these Director assemblies are used in the DS-100 Dual 3-way System (Illustrated above), a single assembly in the SS-100, mounted inside on the shelf above the Flexair woofer enclosure. Chassis easily rotated without moving cabinet, has an 8" m-f unit, compression-driver tweeter, network and control. All frequencies above 600 cycles are reproduced by the Stereo Director assembly. Complete system is also available in kit form.

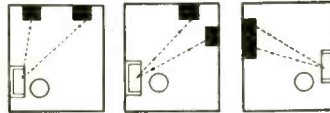

Jensen STEREO DIRECTOR lets you place the speakers wherever decor dictates, square to the wall for best appearance. You send the sound to you, instantly adjust for best stereo listening without moving cabinet.

ABOUT JENSEN'S NEW FLEXAIR WOOFER

The new Jensen Flexair Woofers are designed to extend bass response down to very low frequencies. They have highly-damped superlow resonance at the very bottom of the audio range—16 to 20 cycles. They have an exceptional degree of linearity and are capable of a total movement of 1". In even a relatively small Bass-Superflex enclosure, they deliver their extreme low-frequency performance with a very low in distortion.



JENSEN SS-100 3-WAY SYSTEM WITH THE NEW

Jensen
STEREO DIRECTOR

Equivalent in performance to one section of the DS-100 Dual Stereo system, this elegant model includes Stereo Director Chassis and 12" Flexair woofer in the Jensen Bass-Superflex enclosure for smooth coverage of the range from 20 to 15,000 cycles. Adequately driven to normal room levels with a 10 watt amplifier. Two SS-100's are ideal for stereo in the difficult-to-arrange living room, assuring perfect sound in the favored listening area. 32" H., 21" W., 18 1/4" D. Available in Walnut, Tawny Ash and Mahogany.
Net Price.....179.95



Space speakers, suit decor... always perfect stereo.



Perfect stereo wherever you listen, even with adjacent wall layout.



... BUILDING YOUR OWN STEREO SYSTEM?

Use these new kits for superb sound... finest stereo performance.

DC-3 STEREO DIRECTOR CHASSIS
Mounts m-f and h-f units of KT-33 to make Stereo Director assembly as used in SS-100 reproducers. Includes panel, base, assembly hardware, and complete instructions.

KT-33 BASIC 3-WAY SYSTEM KIT
Includes Flexair 12-inch woofer, special 8 inch m-f unit, and RP-103 compression h-f unit. Complete with control, crossover network, wiring cable, and full instructions. Impedance 16 ohms; power rating 30 watts.

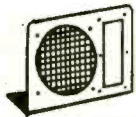

*Trademark, Patents pending.

Jensen

Division of The Muter Company

MANUFACTURING COMPANY
6601 S. Laramie Ave., Chicago 38, Illinois
In Canada: J. R. Longstaffe Co., Ltd., Toronto
In Mexico: Radias Y Television, S.A., Mexico D.F.

NRI'S PROFESSIONAL TELEVISION TRAINING

A Fast Way To Reach The Top In TV Servicing

Oldest and Largest Home Study Radio-TV School Trains You to Fix Any Set Easily, Quickly, Correctly

Professional Television Servicing is a field for the *trained* man, for the expert. The man who knows a "little" will soon be left behind. Time wasted in locating defects by "trial and error" methods can cost *you* money; easily made mistakes can mean callbacks, unhappy customers, even parts that cost money to replace.

Take time to get the training you need to get ahead, enjoy the high pay jobs. That is what NRI's Professional Television Training can do for you. *It is not for the beginner.* NRI's Professional Television Training is planned for the man with some knowledge of Television or Radio but who realizes his need to know *more*; so he can make Television repairs more quickly, confidently and accurately.

All-Practice Method

NRI's Professional Television Training is practical, complete. You do more than read about circuits or just build them. NRI is all-practice, guided training. NRI has spent years in developing training equipment you use to conduct Television Servicing experiments, make tests and thoroughly understand the causes and effects of Television problems. You get practical experience, first hand knowledge of Television Receiver defects, learn how to diagnose them and how to service them.

All equipment is yours, to keep. The professional quality 5" Oscilloscope you build will be a valuable part of your Servicing Equipment. You get other kits, developed to speed your knowledge and confidence, including a 17" picture tube

Scientifically Developed Equipment for Training Makes Learning Fast, Efficient, Practical

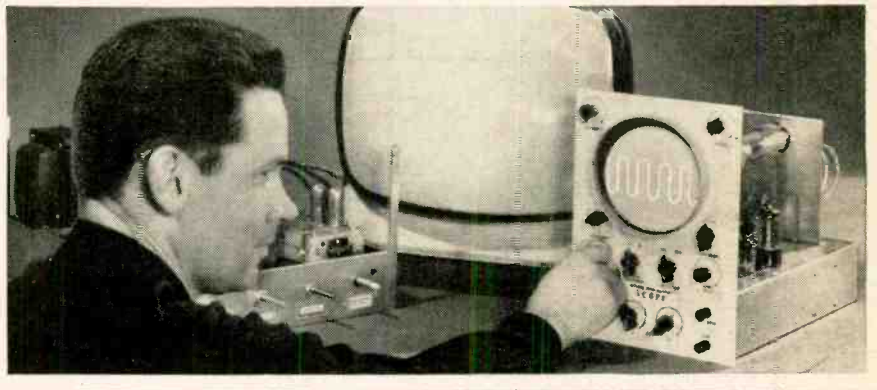

and all components for a TV receiver that you build to learn circuitry and make tests; setting up defects just as they might occur in actual servicing.

ANY MAKE, ANY MODEL Television receiver properly and without wasted time and effort. You know the "what" and the "why" of TV Servicing so you can compete with other professionals.

Color TV Manuals Early

The day you enroll, NRI sends you special Color TV manuals to give you knowledge of this growing phase of TV. Full color pictures, diagrams help speed your training.

Send For FREE Catalog

Mail the coupon now for free catalog of what you learn, equipment supplied. Cost of entire course, all training equipment, Color TV manuals, etc. is low. Monthly terms if desired. NATIONAL RADIO INSTITUTE, Dept., 8JFT, Washington 16, D. C.

There is no better way to get Professional Television Training than through NRI. NRI is the oldest, largest home study Television-Radio school. For over 40 years, NRI's business has been TRAINING men for success in Television-Radio. NRI graduates hold jobs in every part of the industry. NRI methods are tested, proved. You train at home in spare time, get personal attention from instructors who are specialists in Television techniques.

Not For Beginners

NRI's Professional Television course condenses knowledge and experience that would take years of hit-and-miss learning. You learn how *experts* diagnose and repair TV defects. You are shown *professional* techniques to help you service



"The man who learns more... earns more"

The professional TV Serviceman earns good money, enjoys respect and the opportunity of a secure, growing profession. But you can't afford to "guess." You must have training to succeed. NRI can provide it for you.

J.E. Smith
FOUNDER

National Radio Institute

DEPT. 8JFT, WASHINGTON 16, D. C.

Please send my FREE copy of "How to Reach the Top in TV Servicing." I understand no salesman will call.

Name..... Age.....

Address.....

City..... Zone... State.....

Accredited Member National Home Study Council



SEPTEMBER, 1958

Radio-Electronics

Formerly RADIO-CRAFT ■ Incorporating SHORT WAVE CRAFT ■ TELEVISION NEWS ■ RADIO & TELEVISION

EDITORIAL

31 Is Military Radar Doomed?—Hugo Gernsback

AUDIO—HIGH FIDELITY

- 32 The Hi-Fi Amplifier Abroad—A. V. J. Martin
- ✓ 37 Stereo Phono Cartridges, Part I—Julian D. Hirsch
- 40 Improving Radio and Phono Amplifiers—Norman H. Crowhurst
- 42 Speaker System for the Stereo Age—A. Stewart Hegeman and Norman Eisenberg
- 45 New Records and Tapes, Stereo and Monaural—Reviewed by Chester Santon

RADIO

- 46 Chasing the Gremlins Out of Kit Building—Irving Becker
- ✓ 49 How to Service Transistor Radios—H. V. Stewart and C. W. Lightfoot
- 51 And Now, the Crystal Set!

TELEVISION

- ✓ 52 Looking In on London—Hartland B. Smith, W8VVD
- 56 New Circuits in TV Tuners, Part II—E. D. Lucas, Jr.
- 58 Transmission-Line Matching—Henry A. Kampf
- 59 TV Service Clinic—Conducted by Robert G. Middleton
- 61 FM-TV Dx—Robert B. Cooper, Jr.

WHAT'S NEW

- 80 Pictorial Report of New Developments

ELECTRONICS

- ✓ 82 An Electronic Anemometer—Irving M. Gottlieb
- 86 Try These Photocell Circuits—Edwin Bohr
- 92 Diode Clipper-Limiter—Rufus P. Turner
- 95 How's Your Scientific Knowledge?—Rudolf F. Graf

TEST INSTRUMENTS

- ✓ 96 Sync-Circuit Subber—W. G. Eslick
- 100 You Can Measure Phase Shift—Tom Jaski
- 109 Cap-Ohm-Meter—R. C. Sandison

- | | |
|----------------------------------|-------------------------------|
| 138 Books | 128 Patents |
| 133 Business and People | 123 Radio-Electronic Circuits |
| 129 Corrections | 136 Technical Literature |
| 16 Correspondence | 110 Technicians' News |
| 113 New Devices | 126 Technotes |
| 118 New Tubes and Semiconductors | 130 Try This One |
| 6 News Briefs | 125 50 Years Ago |

ON THE COVER

(Story on page 42)

The speakers and part of a special cutaway enclosure reveal some intimate construction details of the Eico HFS-2 speaker system.

Color original by Habershaw Studios, New York, N. Y.

- Hugo Gernsback
..... Editor and Publisher
- M. Harvey Gernsback
..... Editorial Director
- Fred Shunaman
..... Managing Editor
- Robert F. Scott
..... W2PWG, Technical Editor
- Larry Steckler
..... Associate Editor
- David Lachenbruch
..... Associate Editor
- I. Queen
..... Editorial Associate
- Robert G. Middleton
..... Television Consultant
- Elizabeth Stalcup
..... Production Manager
- Cathy Coccozza
..... Advertising Production
- Wm. Lyon McLaughlin
..... Tech. Illustration Director
- Soi Ehrlich
..... Art Director
- Fred Neimast
..... Staff Artist
- Lee Robinson
..... General Manager
- John J. Lamson
..... Sales Manager
- G. Aliquo
..... Circulation Manager
- Adam J. Smith
..... Director, Newsstand Sales
- Robert Fallath
..... Promotion Manager



Average Paid Circulation Over 195,000



RADIO-ELECTRONICS is indexed in *Applied Science & Technology Index* (Formerly *Industrial Arts Index*)

RADIO-ELECTRONICS, September, 1958, Vol. XXIX, No. 9. Published monthly at Mt. Morris, Ill., by Gernsback Publications, Inc. Second-class mail privileges authorized at Mt. Morris, Ill. Copyright 1958 by Gernsback Publications, Inc. All rights reserved under Universal, International and Pan-American Copyright Conventions.

SUBSCRIPTION RATES: U. S., U. S. possessions and Canada, \$4.00 for one year; \$7.00 for two years; \$9.00 for three years; single copies 35c. Pan-American countries \$4.50 for one year; \$8.00 for two years; \$10.50 for three years. All other countries \$5.00 a year; \$9.00 for two years; \$12.00 for three years.

SUBSCRIPTIONS: Address correspondence to Radio-Electronics, Subscription Dept., 404 N. Wesley Ave., Mt. Morris, Ill., or 154 West 14th St., New York 11, N. Y. When requesting a change of address, please furnish an address label from a recent issue. Allow one month for change of address.

GERNSBACK PUBLICATIONS, INC. Executive, Editorial and Advertising Offices, 154 West 14th St., New York 11, N. Y. Telephone ALgonquin 5-7755. Hugo Gernsback, Chairman of the Board; M. Harvey Gernsback, President; G. Aliquo, Secretary.

BRANCH ADVERTISING OFFICES and FOREIGN AGENTS listed on page 141.

POSTMASTER: If undeliverable, send Form 3579 to: RADIO-ELECTRONICS, 154 West 14th St., New York 11, N. Y.

*Trademark registered U. S. Pat. Office.

RADIO-ELECTRONICS

NOW!
at a price
you can afford!

MAKE MORE MONEY in TELEVISION RADIO-ELECTRONICS

**BETTER...MORE COMPLETE...LOWER COST...
WITH NATIONAL SCHOOLS SHOP-METHOD
HOME TRAINING!**

BETTER... Training that is proved and tested in Resident School shops and laboratories, by a School that is the **OLDEST** and **LARGEST** of its kind in the world.

MORE COMPLETE... You learn **ALL PHASES** of *Television-Radio-Electronics*.

LOWER COST... Other schools make several courses out of the material in our **ONE MASTER COURSE**... and you pay more for less training than you get in *our course* at **ONE LOW TUITION!**



These
two FREE books will
show you how!

You get all information
by mail... You make
your own decision... at
home! **NO SALESMAN
WILL CALL**

TOP PAY... UNLIMITED OPPORTUNITIES LIFETIME SECURITY CAN BE YOURS!

You are needed in the Television, Radio, and Electronics industry! Trained technicians are in growing demand at excellent pay—in **ALL PHASES**, including Servicing, Manufacturing, Broadcasting and Communications, Automation, Radar, Government Missile Projects.

NATIONAL SCHOOLS SHOP-METHOD HOME TRAINING, with newly added lessons and equipment, trains you in your spare time at home, for these unlimited opportunities, including many technical jobs leading to supervisory positions.

YOU LEARN BY BUILDING EQUIPMENT WITH KITS AND PARTS WE SEND YOU. Your National Schools course includes thorough *Practical* training—**YOU LEARN BY DOING!** We send you complete standard equipment of professional quality for building various experimental and test units. You advance step by step, perform more than 100 experiments, and you build a complete TV set from the ground up, that is yours to keep! A big, new TV picture tube is included at no extra charge.

EARN AS YOU LEARN. We'll show you how to earn extra money right from the start. Many of our students pay for their course—and more—while studying. So can you!

RESIDENT TRAINING AT LOS ANGELES

If you wish to take your training in our Resident School at Los Angeles, the world's TV capital, start NOW in our big, modern Shops, Labs and Radio-TV Studios. Here you work with latest electronic equipment—professionally installed—finest, most complete facilities offered by any school. Expert, friendly instructors. Personal attention. Graduate Employment Service. Help in finding home near school—and part time job while you learn. Check box in coupon for full information.

LESSONS AND INSTRUCTION MATERIAL ARE UP-TO-DATE, PRACTICAL, INTERESTING. Every National Schools Shop-Method lesson is made easy to understand by numerous illustrations and diagrams. All instruction material has been developed and tested in our own Resident School Shops, Laboratories and Studios.

SEND FOR INFORMATION TODAY... it can mean the difference between **SUCCESS** and failure for you! Send for your **FREE BOOK** "Your Future in Television-Radio-Electronics" and **FREE Sample Lesson**. Do it **TODAY**, while you are thinking about your future. It doesn't cost you anything to investigate!

GET THE BENEFITS OF OUR OVER 50 YEARS EXPERIENCE

Approved for
GI Training



NATIONAL SCHOOLS

Los Angeles 37, Calif.

YOU GET...

- 19 Big Kits—**YOURS TO KEEP!**
- Friendly Instruction and Guidance
- Job Placement Service
- Unlimited Consultation
- Diploma—Recognized by Industry
- **EVERYTHING YOU NEED FOR SUCCESS!**

**SHOP-METHOD HOME TRAINING
COVERS ALL PHASES OF INDUSTRY**

1. Television, including Color TV
2. Radio AM & FM
3. Electronics for Guided Missiles
4. Sound Recording and Hi-Fidelity
5. FCC License
6. Automation and Computers
7. Radar & Micro-Waves
8. Broadcasting and Communications

NATIONAL TECHNICAL SCHOOLS
WORLD-WIDE TRAINING SINCE 1905

MAIL NOW TO

NATIONAL SCHOOLS, Dept RG-EE

4000 S. FIGUEROA ST. LOS ANGELES 37 CALIF.

Rush free TV-Radio "Opportunity" Book and sample lesson. No salesman will call.

NAME _____ AGE _____

ADDRESS _____

CITY _____ ZONE _____ STATE _____

Check if interested **ONLY** in Resident School training at Los Angeles.
VETERANS: Give date of Discharge.

FOR
A brighter
TV picture

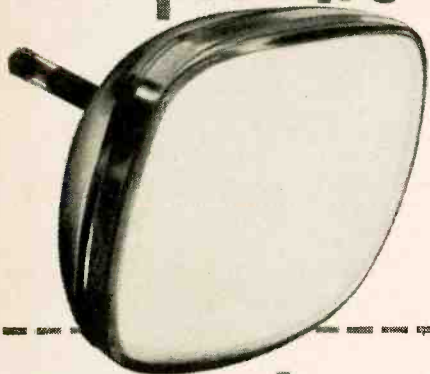

FOR
A brighter
profit.
picture



Keep your customers sold on you! Use the exact same tubes leading independent set makers specify. Tell your supplier you'd rather have Tung-Sol Tubes.

Tung-Sol Electric Inc., Newark 4, N. J.

TUNG-SOL
MAGIC MIRROR ALUMINIZED
PICTURE TUBES
RECEIVING TUBES

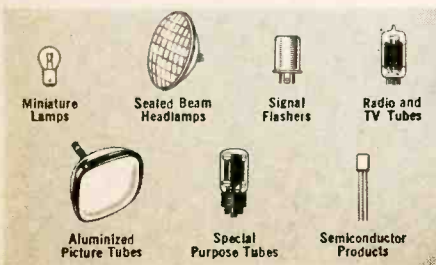

News Briefs



STEREO PHONO EQUIPMENT and "ready-for-stereo" units have become available in an extensive profusion of combinations and permutations. All phonograph manufacturers have taken note of stereo in their 1959 models and the buyer of so-called "packaged hi fi" has a choice of stereo sets ranging in price from \$59.50 to \$2,500. If he is interested in a phonograph but does not want to invest in stereo immediately, manufacturers assure him that all their new-model monophonic phonographs are easily converted to stereo.

In this monophonic-but-ready-for-stereo field, the buyer has these choices:

1. Standard sets that can be converted with a kit containing stereo cartridge and leads plus adding another amplifier and speaker system.

2. Sets with monophonic cartridge but with four leads in the pickup arm, so that a stereo cartridge and an additional plug-in amplifier and speaker can be connected easily.

3. Sets with stereo pickups and one amplifier. These can be made into stereo phonographs by adding another amplifier and speaker.

4. Sets with stereo pickups and dual-channel amplifiers, requiring only an extra speaker to make them complete stereo rigs.

Most manufacturers offer two or more of these choices; at least one offers all four, plus complete stereo outfits.

The complete stereo phonographs are available in single, two- and three-cabinet models. The single cabinets are usually of lowboy design, with speakers mounted at opposite ends. Some of the three-cabinet models have three separate speaker systems (the center unit combining both channels to fill the "hole in the middle" sometimes noted).

ELECTRONIC COOLER-WARMER for baby's bottle, less than half a cubic foot in size, has been demonstrated by Westinghouse Electric Corporation, which outlined a whole new range of compact household appliances which both heat and cool, at the National Housewares Manufacturers Association show at Atlantic City, N. J.

The cooling-heating appliances are

based on the effect discovered by Peltier in 1834—that passing electricity through junctions of two dissimilar materials creates heating or cooling, depending on the current's direction. RCA's widely known research in electronic refrigeration and air conditioning is founded on the same principle.

The bottle cooler-warmer contains 50 junctions mounted geometrically around an aluminum container. Vertical aluminum fins dissipate removed heat. It keeps the bottle cool at 40° or heats it to 100° and was shown in 110-volt ac and automobile models.

Westinghouse said its electronic refrigerating-heating equipment occupies about 10% less space than would comparable compression refrigeration gear, requires "at least 50% less apparatus" and is free of noise and vibration. Still in the developmental stage, company officials predicted that thermoelectric cooling would replace conventional refrigeration techniques in the "not too far future."

Also demonstrated was a mobile hostess cart with separate compartments to keep food warm or cool, operated from both a rechargeable battery and line current. Other possible household products using the same principle which were itemized (but not demonstrated) by vice president Chris J. Witting: heating and cooling pads or blankets, refrigerated mixing bowls, electric Thermos bottles, cooling coasters, combination freezer-cookers.

"SANDWICH" MAGNETIC TAPE, introduced for computer and instrumentation use, has magnetic material on the inside of the tape where it doesn't contact the recording head. The secret is a plastic layer, 50 micro-inches thick, covering the oxide coating. The manufacturer, Minnesota Mining & Manufacturing Co., claims it outwears conventional instrumentation tapes by 10 times or more and prolongs recording- and playback-head life because it doesn't deposit oxide on them.

The thin tape layer between the coating and the head reduces the signal level approximately 6 db at 1-mil wavelength. Medium- and long-wavelength responses are essentially unaffected.

MICROWAVE AMPLIFIER which can be packed into a space of 4 cubic inches and offers the possibility of far more efficient performance of radar equipment in aircraft and missiles, has been developed by RCA Laboratories.

Classified as a basic improvement in the solid-state device known as a para-
(Continued on page 10)



In Spare Time at Home—Prepare for a Better Job—or
Your Own Business in One of the Many Branches of

ELECTRONICS



You build and keep this valuable Vacuum Tube VOLT-METER



You build and keep this 5-inch COLOR OSCILLOSCOPE—almost a "must" for TV servicing.

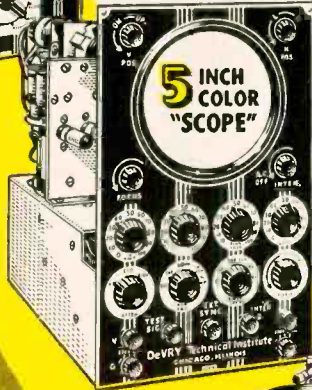

RADIO - TELEVISION - RADAR

If you are seeking a better job or a business of your own, the appealing field of Television-Radio-Electronics offers REAL PROMISE!

In this fast-growing field, trained Electronic technicians find many good-paying, interesting jobs in manufacturing, installing, operating, servicing. Equally important is the fact that these are GOOD JOBS—offering the kind of a future that an untrained man often dreams about.

No previous technical experience or advanced education needed. Prepare for this profitable field in your spare time at home, or in our modern Chicago or Toronto Laboratories. Nothing else like it! Send for FREE details.



HOME MOVIES . . .

. . . make important points crystal clear. Speeds your learning. It's almost like having an instructor at your side!

MILITARY SERVICE

If you are subject to military service, the information you have should prove very helpful. Mail coupon today.



21 INCH

Build and keep this BIG DeVry Engineered TV set—easily converted to U.H.F. (DeVry offers another home training, but without the TV set.)

EARN WHILE YOU LEARN

After you get part of DeVry Tech's training with equipment at home, you may then in your spare time, begin to earn real money servicing Radio and Television sets.

COLOR TV

DeVry Tech's program also includes training in Color Television

Your GUIDE

to Profitable Job Opportunities

- TV-Radio Broadcast Technician
- Color Television Specialist
- Radar Operator • Laboratory Technician
- Airline Radio Man • Computer Specialist
- Quality Control Manager
- Your Own Sales & Service Shop
- . . . PLUS MANY OTHERS

YOU GET THE SAME EMPLOYMENT SERVICE

that has helped thousands of our graduates toward fine careers in Electronics.



Send for **FREE BOOKLET TODAY!**

Accredited Member of National Home Study Council

"One of North America's Foremost Electronics Training Centers"



DeVRY TECHNICAL INSTITUTE

Formerly DeForest's Training, Inc.
CHICAGO 41, ILLINOIS



Build over 300 practical projects from many shipments of Radio-Electronic parts. You build and operate TV-Radio circuits . . . wireless microphone . . . and many other major projects—all designed to provide outstanding practical experience at home.

ACT NOW!

Get information-packed publication FREE! Mail coupon today.

DeVRY TECHNICAL INSTITUTE

4141 Belmont Ave., Chicago 41, Ill., Dept. RE-9-O

Please give me your FREE booklet, "Electronics and YOU," and tell me how I may prepare to enter one or more branches of Electronics.

Name _____ Age _____

Street _____ PLEASE PRINT Apt. _____

City _____ Zone _____ State _____

2044 Canadian residents address DeVry Tech of Canada, Ltd.
626 Roselawn Ave., Toronto 12, Ontario

*Mr. Service Dealer:
Show Your TV-Radio Service Customer
Where His Dollar Goes!*

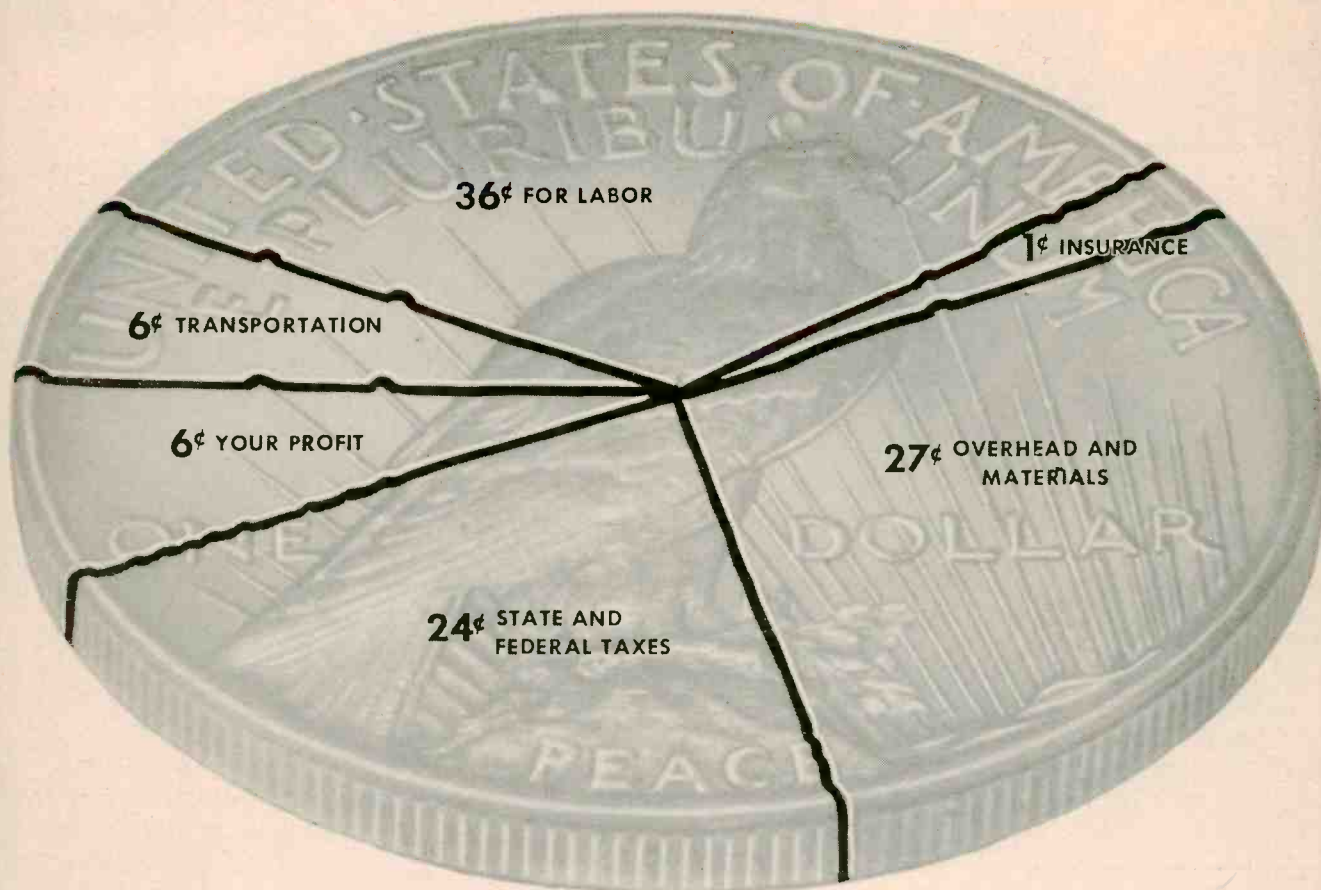

Let your customers know how much they get and how little you make on an average service call. Show them this chart. It was compiled by an independent organization for Raytheon and is based on research of Independent TV-Radio Service Dealer costs from coast to coast. It might be a good idea if you studied it carefully to see if any phase of your business is costing more than it should.

And remember: This 6¢ piece is your profit on a call. Don't lose it. One of the best ways to protect it is to avoid costly call-backs. And the best way to avoid call-backs is to always replace with Raytheon quality TV and Radio Tubes. Ask your Raytheon Tube Distributor to fill your orders with Raytheon Tubes.



COMING SOON! Your Chance To Climb On The GOLDEN LADDER



RAYTHEON MANUFACTURING COMPANY

Distributor Products Division

NEWTON 58, MASS. 55 Chapel Street
 CHICAGO, ILL. 9501 Grand Ave. (Franklin Park)
 ATLANTA 6, GA. 1202 Zonolite Rd. N.E.
 LOS ANGELES 7, CALIF. 2419 So. Grand Ave.

Raytheon makes all these } Receiving and Picture Tubes, Reliable Subminiature and Miniature Tubes, Semiconductor Diodes and Transistors, Nucleonic Tubes, Microwave Tubes.



Every Essential Term in Physics and Electronics – 12,000 of Them – now in one giant dictionary!

Send today for a free-examination copy of this 1000-page reference work. Used in homes, offices, schools and laboratories.

THE INTERNATIONAL DICTIONARY OF PHYSICS AND ELECTRONICS is the only book available today that gives you – right at your fingertips – definitions, equations, principles and thorough explanations of every important term in physics and electronics.

More than 12,000 laws, relationships, equations, basic principles, instruments, apparatus and techniques are described in half a million words. You'll find everything from alphatopic, band and cybotaxis to Wronksian, ylem and Zwitterion.

16 Reference Books in One

You've never seen so much useful information in one volume. It takes the place of a whole library of reference books on:

Electronics	Units and Dimensions
Meteorology	General Principles
Mechanics	Heat and Thermodynamics
Gases	Atomic and Nuclear Physics
Liquids	Mathematical Physics
Solids	Quantum Mechanics
Acoustics	Electricity
Optics	Relativity

No more hunting around from book to book for the information you need. No more wading through long texts to get a simple definition. Everything you need can be found simply and quickly in this one handy volume.

Answers Your Questions in Seconds

A unique system of cross-referencing helps you locate information instantly. Each article is arranged progressively, beginning with a concise definition and adding additional details in later paragraphs. Boldface "word signals" refer you to other articles relating to the one you are reading. You get the answers you want in a hurry!

Save Time – Avoid Costly Errors

You'll turn to this giant, 1000-page reference work dozens of times a day – to recheck your work, to clarify technical articles or engineering data, to increase your own understanding of the complex world of physics and electronics. Where you might otherwise trust your memory, you'll now turn to the International Dictionary of Physics and Electronics to get an answer you can be sure of. This helpful volume can pay for itself many times over in just one avoided error!

Examine it For 10 Days FREE

To fully appreciate the usefulness of this big 2¼" thick book, we invite you to use it for ten days. If you do not find it to be one of the most valuable books you have ever owned, you may simply return it and owe nothing. Otherwise, remit payment on the easy terms indicated in coupon. You take no risk. Send coupon today to **D. Van Nostrand Co., Inc., Dept 189, 120 Alexander St., Princeton, N. J. (Established 1848).**

Acclaimed by Major Journals in Every Field of Science

"Unique. Useful. Presents a wide variety of terms"

– SCIENTIFIC AMERICAN

"Remarkably complete. Highly useful. Provides definite and concise answers to a myriad of questions."

– PHYSICS TODAY

"Will undoubtedly make a

well-deserved place for itself."

– SCIENCE

"There has been a real need for such a work."

– ELECTRONICS

"Recommended for all that do any reference work in physics."

– LIBRARY JOURNAL

"Unique in its field and exceptionally clear in its typography. It should prove a most useful reference."

– NUCLEONICS

"The best book of definitions available on the market today. Highly recommended."

– TELE-TECH

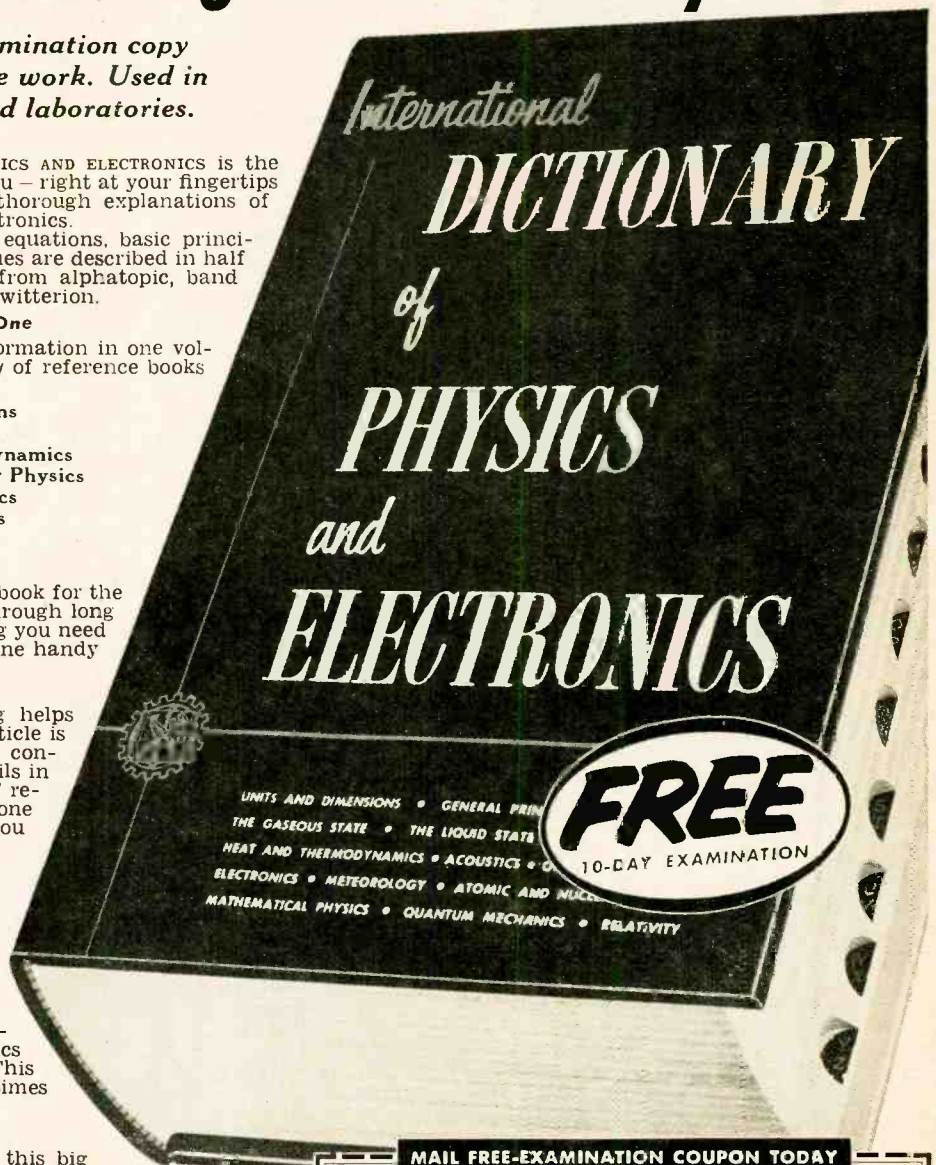

MAIL FREE-EXAMINATION COUPON TODAY

**D. Van Nostrand Company, Inc., Dept. 189
120 Alexander Street, Princeton, N. J.**

Please send me – for 10 days' FREE examination – the "International Dictionary of Physics and Electronics" thumb-indexed edition. If not completely satisfied, I may return it and owe nothing. Otherwise I will remit \$7.50 plus small shipping cost, and \$5 a month for 3 months.

Name.....

Address.....

City.....Zone.....State.....

Save! Enclose full payment (\$22.50) and shipping costs will be prepaid. Money back if not delighted.

In Canada: Order from D. Van Nostrand Co., Ltd., 35 Holinger Road, Toronto 16, Canada (Price slightly higher!)

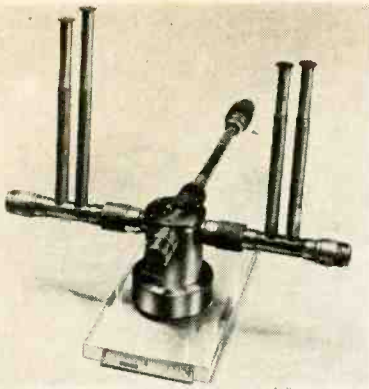

metric microwave amplifier, it uses a germanium diode to detect an incoming high-frequency signal and either a transistor or a pencil type tube oscillating at a low frequency to provide a "pumping" action that amplifies the signal. Parametric amplifiers have been developed in the past, but the pumping frequency was always at least twice that of the signal. According to RCA, the new technique places the parametric amplifier principle "in an entirely new light."

The new development holds particular promise at the higher end of the microwave band—even to frequencies above 10,000 mc. It requires a power supply of only a fraction of a watt, and its size permits extreme miniaturization.

FOUR UHF TV STATIONS left the air since our last report:

KSAN-TV, San Francisco, Calif....32
 WITV, Fort Lauderdale-Miami, Fla. 17
 WFLB-TV, Fayetteville, N. C.18
 WKAR-TV, East Lansing, Mich.60

No new stations went on the air during the period, reducing the total now broadcasting to 538 (447 vhf and 91 uhf). Of these 30 are noncommercial. WKAR-TV, a noncommercial station owned by Michigan State University, was the second educational TV station to leave the air.

Another uhf station is due to go off the air Oct. 1. It is WBUF, Buffalo, Channel 17, owned by the National Broadcasting Co.

There has been one change in call letters:

WLBZ-TV, Bangor, Me.2
 (formerly WTWO)

Though the number of television stations diminished over the 30-day period, radio stations are at an all-time high. A recent survey shows 3,253 AM broadcast stations on the air at midyear, an increase of 42 since the first of the year and almost 3 times as many as there were at the end of World War II. There are 548 FM outlets on the air, up 8 during the year, but still well below FM's all-time high of 706.

NEW USES FOR FM broadcast band are being sought by the Federal Communications Commission, which has asked for proposals for "subsidiary services" which could be instituted without disturbing FM broadcasting. The FCC specifically mentioned use of the multi-

How to Pass

An FCC License can be

Get Your FCC License

We Guarantee
to train you until you receive
Your FCC License

Completion of the Master Course (both Sections) will prepare you for a First Class Commercial FCC License with a radar endorsement. Completion of Section 1 only of the Master Course will prepare you for a Second Class Commercial FCC License. We guarantee to train and coach you, without any additional cost, until you receive the FCC License as indicated above. This guarantee is valid for the entire period of your enrollment agreement.

Cleveland Institute Training Results in success with commercial FCC examinations . . . easily . . . and quickly.

Free!

FIND OUT HOW:

- 1. The new electronic devices can be handled by you**
- 2. To solve the problems that will stump your fellow technicians**
- 3. Training is Job Insurance when employment is tough to find . . . and more money for you when times are good**

Mail Coupon NOW . . .

(Commercial)

FCC License Exams

your Guarantee of Success in Electronics

in a Minimum of Time

mail
coupon
NOW!

here's proof of good jobs

Irving Laing:

"Your lessons are helping me a lot in my Navy work. You cover topics that were not presented by the Navy at the E.T. School. . . . Your course has helped greatly to get my 2nd class FCC ticket. I am now a radio and T.V. engineer at WTVS and WDTR in Detroit, Michigan."

*Irving L. Laing,
15887 Robson,
Detroit 27, Michigan*

Get all 3 FREE

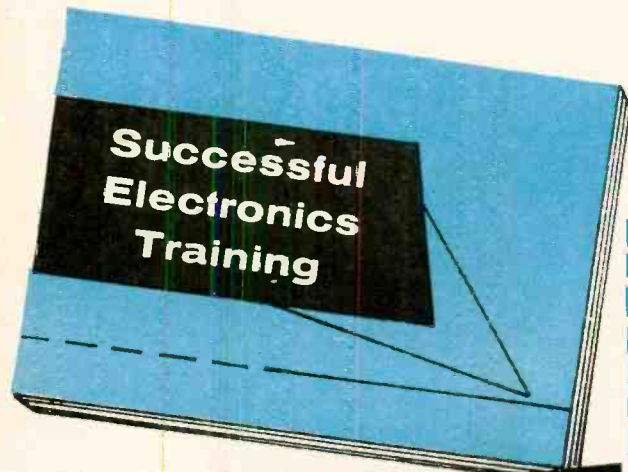
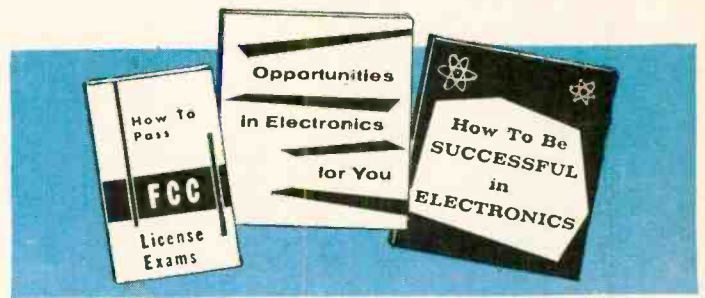

Accredited by The National Home Study Council

Cleveland Institute of Radio Electronics

Desk RE-21, 4900 Euclid Ave., Cleveland 3, Ohio



Please send FREE Booklets prepared to help me get ahead in Electronics. I have had training or experience in Electronics as indicated below:

- | | |
|---|---|
| <input type="checkbox"/> Military | <input type="checkbox"/> Broadcasting |
| <input type="checkbox"/> Radio-TV Servicing | <input type="checkbox"/> Home Experimenting |
| <input type="checkbox"/> Manufacturing | <input type="checkbox"/> Telephone Company |
| <input type="checkbox"/> Amateur Radio | <input type="checkbox"/> Other..... |

In what kind of work are you now engaged?.....

In what branch of Electronics are you interested?.....

Name..... Age.....

Address.....

City..... Zone..... State.....

Special Tuition Rates to Members of Armed Forces Desk RE-21,

Receive All These Booklets FREE!

Mr. Dealer
PHILCO

offers you a Complete and Universal line of
FULL FIDELITY NEEDLES

- DIAMOND
- SAPPHIRE
- OSMIUM

Now, one complete line of precision-engineered and custom-designed needles to fit every make and model phonograph and High Fidelity receiver. Every Philco needle measures up to the highest quality and life test standards. All Philco needles are individually packaged for absolute protection.



FREE! NEEDLE COUNTER DISPLAY!

Ask your Philco Distributor how you can get this sparkling, jewel case needle dispenser free. It's a sales-maker for you right on your counter at the point of sale.

COMPLETE PHILCO NEEDLE CATALOG

The most accurate, up-to-date, easy-to-read needle catalog in the industry. Cross references are complete... Illustrations are big... Makes selling easy.



PHILCO FIDELITAPE

will bring new customers into your store. Unequaled in uniformity of output. Guaranteed splice free. Extra strength and extra length.

See Your Philco Distributor Today!



World-Wide Distribution

- Service Parts • Power-Packed Batteries • Universal Components • Long-Life Tubes • Heavy-Duty Rotors • Star-Bright 20/20 Picture Tubes • Long-Distance Antennas • Appliance Parts • Laundry Parts • Universal Parts and Accessories



plex technique to provide such special services as facsimile, stock market reports, slow-scan video transmission of advertisements, price quotations for supermarkets, paging service, traffic light control and stereophonic broadcasting, on a free or subscription basis.

One unusual application of multiplexing is already in operation. Station KDKA-FM, Pittsburgh, has been using a multiplex subchannel to feed Pittsburgh Pirates baseball games to 20 radio stations in the surrounding area. The station continues to broadcast its regular classical music programs on its main carrier channel. The multiplex channel programs can't be received without special equipment. Although multiplexing of subscription background music service by FM stations has been authorized for nearly 3 years, the Pittsburgh authorization was the first official sanction of non-musical multiplexing on a regular basis.

Calendar of Events

- Hi-Fi Music Show**, Sept. 5-7, DeWitt Clinton Hotel, Albany, N. Y.
- Keystone Electronic Service Conference and Exhibition**, Sept. 10-13, Carnegie Hall, Pittsburgh, Pa.
- Instrument-Automation Conference and Exhibit**, Sept. 15-19, Convention Hall, Philadelphia, Pa.
- High Fidelity Show and Music Festival**, Sept. 19-21, Palmer House, Chicago, Ill. (RADIO-ELECTRONICS and the Gernsback Library will exhibit in Room 746.)
- Hi-Fi Music Show**, Sept. 19-21, Onandaga Hotel, Syracuse, N. Y.
- National Symposium of Telemetering**, Sept. 22-24, Americana Hotel, Miami Beach, Fla.
- Industrial Electronics Conference**, Sept. 24-25, Rackham Memorial Bldg., Detroit, Mich.
- Hi-Fi Music Show**, Sept. 26-28, Sheraton Hotel, Rochester, N. Y.
- High Fidelity Show**, Sept. 30-Oct. 4, Trade Show Bldg., New York, N. Y. (RADIO-ELECTRONICS and the Gernsback Library will exhibit in Room 525.)
- Symposium on Engineering Writing and Speech**, Oct. 1-2, Biltmore Hotel, New York.
- Conference on Radio Interference Reduction**, Oct. 1-2, Armour Research Institute, Chicago, Ill.
- Hi-Fi Music Show**, Oct. 3-5, Multnomah Hotel, Portland, Ore.
- Hi-Fi Music Show**, Oct. 3-5, Hotel Statler, St. Louis, Mo.
- American Industrial Electronics Exposition**, Oct. 3-12, Planten un Blomen Exposition Park, Hamburg, Germany.
- IRE Canadian Convention**, Oct. 8-10, Exhibition Park, Toronto, Canada.
- Hi-Fi Music Show**, Oct. 10-12, Benjamin Franklin Hotel, Philadelphia, Pa.
- Hi-Fi Music Show**, Oct. 10-12, Sheraton-Gibson Hotel, Cincinnati, Ohio.
- National Electronics Conference**, Oct. 13-15, Hotel Sherman, Chicago.
- Hi-Fi Music Show**, Oct. 17-19, Hotel Statler, Detroit, Mich.
- New England Hi-Fi Show**, Oct. 17-19, Hotel Touraine, Boston, Mass.
- Society of Motion Picture & Television Engineers Convention**, Oct. 19-24, Sheraton-Cadillac Hotel, Detroit, Mich.
- URSI Fall Meeting**, Oct. 21-22, Penn State, Univ., University Park, Penna.
- Hi-Fi Show**, Oct. 23-26, Wisconsin Hotel, Milwaukee, Wis.
- Radio-Fall Meeting**, Oct. 27-28, Sheraton Hotel, Rochester, N. Y.
- Hi-Fi Show**, Oct. 29-Nov. 1, Windsor Hotel, Montreal, Canada.
- Electron Devices Meeting**, Oct. 30-Nov. 1, Shoreham Hotel, Washington, D. C.

END

Amazing New COYNE *Pin-Point* TROUBLE SHOOTING Series

Takes the Headaches Out of TV and Record Changer Servicing!

NOW! See Complete Series on 7-Day **FREE TRIAL!**

EASY TO USE!

SAVES TIME!



Pin-Point RECORD CHANGER TROUBLES

IN 5 MINUTES
Helps you locate record-changer mechanical troubles right in the home, without even removing the changer from the cabinet! Covers every American make changer, plus most foreign makes... HI-FI; make changer... also single, three and four-speed changers... helps spot audio troubles. Over 320 spiral bound pages; 450 time-saving photos; 58 Check Charts. Fully indexed.

BRAND NEW!

\$3.95

ELIMINATES GUESSWORK!

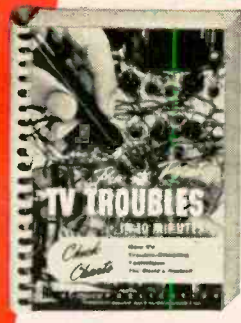

Pin-Point TV TROUBLES

IN 10 MINUTES
The most useful TV servicing "tool"! Quickly and easily pin-points the exact spot in any TV set, from tie! Spiral bound book contains over 300 fast saving Check Charts; 290 important diagrams and photos; explanations of circuits and designs.

\$3.95

NOTHING LIKE IT!



Pin-Point COLOR TV TROUBLES

IN 15 MINUTES
Nothing else like it for trouble-shooting COLOR TV video and audio problems quickly and accurately. Covers every type of COLOR TV trouble; every type of COLOR TV picture tube in use, including single and 3-gun, round and rectangular. 550 spiral bound pages; hundreds of important illustrations including picture patterns of COLOR TV troubles; 362 Check Charts, diagrams and photographs.

\$5.95

Saves Time... Makes You More Valuable!

A practical source for finding the cause of trouble in any TV set and any record-changer, FAST! Tells you in which section of a particular set you'll find the cause of trouble. Check Chart then help you accurately locate the exact trouble spot. You cut the greatest time waster in servicing—the time spent finding what's wrong. You become more valuable and put yourself in line for more money, greater profits and greater customer satisfaction.

Practical "Tools"—Not Textbooks— No Need To Read Completely And Memorize!

These "PIN-POINT" books were designed exclusively for on-the-job trouble-shooting... published by the famous Coyne Electrical School... and approved by leading authorities in the field. A ready reference—you simply turn to the indexed section; in a few minutes you have the trouble spot located and ready for repair. Books are spiral bound; lie flat when opened. The hours and aggravation any one of these books can save you on a single servicing call can pay for the series!

Send No Money—Try Set Free For 7 Days

You must see these sensational new books to fully appreciate how much time and trouble they can save you. So we'll let you use any or all of them for a full week, without cost! **SEND NO MONEY.** Just mail the coupon. We'll rush books you want, on **FREE TRIAL.** Try them for 7 days. Then send only the low price, or return books and owe nothing. If you want to keep all 3 books, send only \$3 after 7 days and \$3 per month, until \$13.85, plus postage, is paid. No interest, no carrying charges, no risk. Take advantage of this offer NOW!

SERVICEMEN SAY THESE BOOKS ARE BEST!

"I received your book 'Pin-Point TV Troubles in 10 Minutes' and want to say that I would not part with it for \$500.00 if I could not get another copy."
Clyde H. Young, East St. Louis, Mo.
"Pin-Point Record Changer Troubles in 5 Minutes' is a must in every serviceman's library."
Roy V. Hill, Kansas City, Mo.
"Regarding your book, 'Pin-Point Troubles', I cannot see for the life of me how you can manage to include so much information at such unbelievably low prices."
H. L. Grotjahn, New York

FREE TRIAL OFFER COUPON... MAIL NOW!

Educational Book Publishing Division
COYNE ELECTRICAL SCHOOL, Dept. 98-T1
500 S. Paulina St., Chicago 12, Ill.

Rush complete 3-Book TROUBLE-SHOOTING SERIES for 7 days **FREE TRIAL**, per your offer. Include copy of "Bigger Profits in TV" **FREE!** Cash price of complete series—\$13.85; we pay postage. (Time payment plan on complete series only: \$3.00 after 7 days and \$3.00 per month until \$13.85 plus postage is paid.)
If you do not want complete series, check below the books you want on 7 days **FREE TRIAL.**

- PIN-POINT RECORD CHANGER TROUBLES (\$3.95 plus postage)
- PIN-POINT COLOR TV TROUBLES (\$5.95 plus postage)
- PIN-POINT TV TROUBLES (\$3.95 plus postage)

Name _____ Age _____

Address _____

City _____ Zone _____ State _____

Check here if you are enclosing full price. We pay postage. 7-day money-back guarantee.



Get This Valuable **FREE** Gift

Just For Examining COYNE'S Pin-Point Series
This valuable money-making book, "BIGGER PROFITS IN TV", is yours **FREE**, just for asking to see all 3 Coyne trouble-shooting books. A "must" for the man planning to start his own shop; a practical aid for the man already in business; helps you make the big money in television servicing. Tells how to keep records... what your labor is worth... legal angles of business... much more. 122 pages, fully illustrated. Sells for \$1.50. Yours **FREE**, whether you keep the three books or not. Mail coupon NOW!

COYNE ELECTRICAL SCHOOL
Educational Book Publishing Division
500 S. PAULINA ST., DEPT. 98-T1, CHICAGO 12, ILLINOIS



GOLDEN INVADER

The Antenna That Beats Them All!

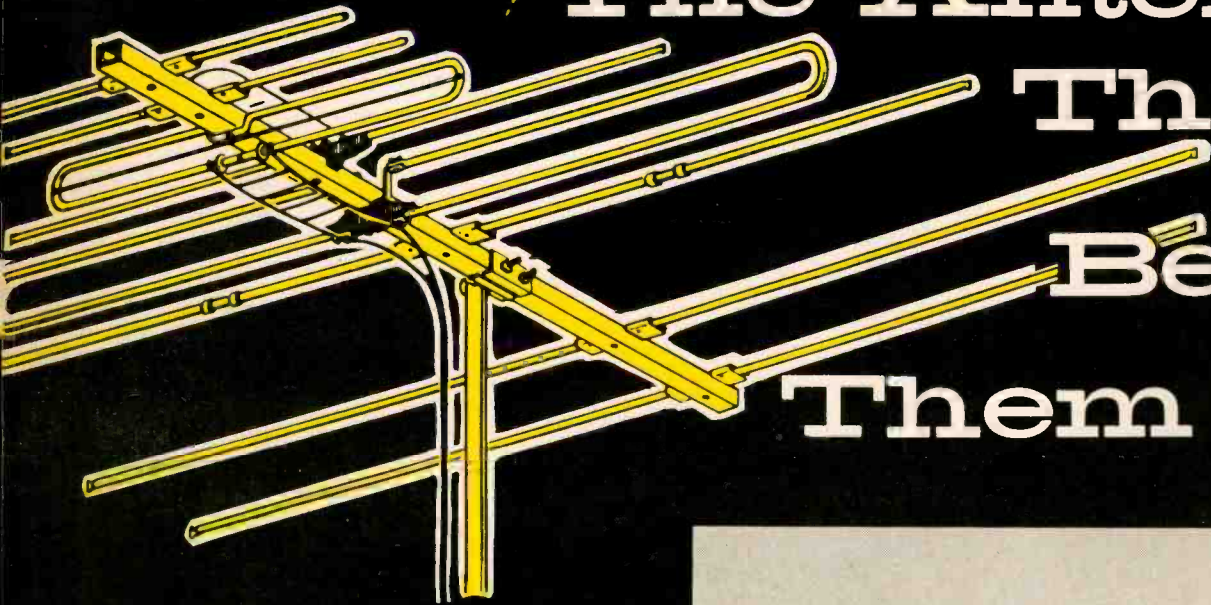

TRY TELCO'S NEW GOLDEN INVADER, the powerful antenna for VHF fringe areas and UHF primary areas. Extensive tests prove its uni-plane design can pull in stations from as far as 200 miles away. Ghosts and co-channel interference are eliminated. The GOLDEN INVADER, for color or black-and-white TV, comes pre-assembled with the new Snap-Lock construction that makes it easier to handle, easier to install. Available in single bay (illustrated), two-bay or four-bay models.

- SUPER SHARP DIRECTIVITY
- BEAUTIFUL GOLD ANODIZING
- NEW SNAP-LOCK DESIGN
- RECEPTION UP TO 200 MILES AWAY

SEE US
AT THE
PARTS
SHOW

No. A-8121 Single Bay.....List \$29.95

A-8122 Two-Bay.....59.95

VALUABLE BONUS FOR YOU!

Enclosed with each TELCO GOLDEN INVADER is a special Golden Bonus Certificate. Look for these Certificates . . . save them. They're valuable to you!

UNCONDITIONAL GUARANTY...

A Telco Exclusive! TELCO guarantees the GOLDEN INVADER and all Telco Antennas to be free from defects in materials and workmanship. This guarantee on the Golden Invader is for *three* years. All other antennas are guaranteed for one year.



TELCO ELECTRONICS MFG. CO.

Division of G-C - Textron Inc. • Los Angeles 18, Cal. • Rockford, Ill., U.S.A.

THE COMPLETE LINE OF TELCO POWER PACKED ANTENNAS

CONICALS

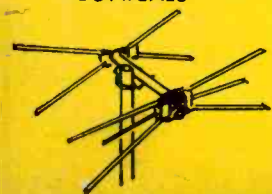

YAGIS

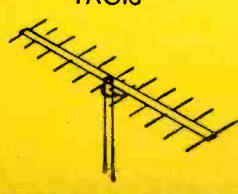

INLINES

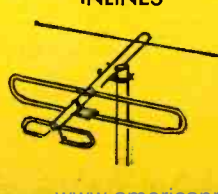

BOW TIES



INDOORS

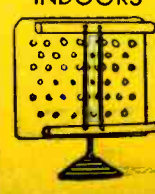

ANTENNA KITS



MAKE MORE MONEY

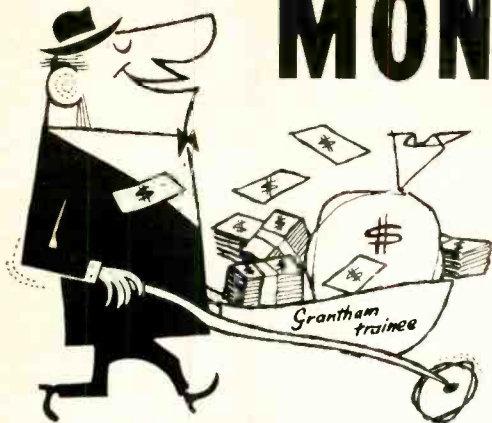

TRAIN FOR ELECTRONICS

F.C.C. LICENSE—THE KEY TO BETTER JOBS

An F.C.C. *commercial* (not amateur) license is your ticket to higher pay and more interesting employment. This license is Federal Government evidence of your qualifications in electronics. Employers are eager to hire *licensed* technicians.

WHICH LICENSE FOR WHICH JOB?

The **THIRD CLASS** radiotelephone license is of value primarily in that it qualifies you to take the second class examination. The scope of authority covered by a third class license is extremely limited.

The **SECOND CLASS** radiotelephone license qualifies you to install, maintain and operate most all radiotelephone equipment except commercial broadcast station equipment.

The **FIRST CLASS** radio telephone license qualifies you to install, maintain and operate every type of radiotelephone equipment (except amateur) including all radio and television stations in the United States, its territories and possessions. This is the highest class of radiotelephone license available.

This booklet FREE!

This free booklet gives details of our training and explains what an F.C.C. license can do for your future. Send for your copy today.

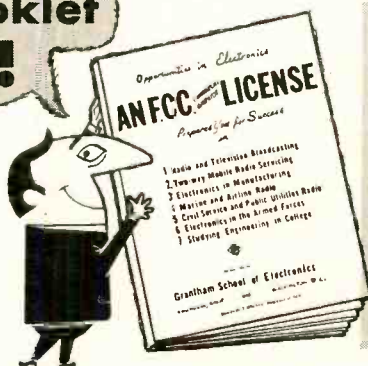

for **FREE** Booklet **CLIP COUPON** and mail in envelope or paste on postal card.

GRANTHAM TRAINING PREPARES YOU

The Grantham Communications Electronics Course prepares you for a **FIRST CLASS F.C.C.** license, and it does this by **TEACHING** you electronics. Each point is covered simply and in detail, with emphasis on making the subject easy to understand.

LEARN BY CORRESPONDENCE OR IN RESIDENT CLASSES

Grantham School of Electronics *specializes* in F.C.C. license preparation. Correspondence training is conducted from Washington, Hollywood, and Seattle; also, resident **DAY** and **EVENING** classes are held in all three cities. Either way, by correspondence or in resident classes, we train you quickly and well. A beginner may qualify for his first class F.C.C. license in as little as 12 weeks!

OUR GUARANTEE

If you should fail the F. C. C. exam after finishing our course, we guarantee to give additional training at **NO ADDITIONAL COST**. Read details in our free booklet.

GET YOUR FIRST CLASS COMMERCIAL

F.C.C. LICENSE IN ONLY 12 WEEKS

HERE'S PROOF . . .

that Grantham students prepare for F.C.C. examinations in a minimum of time. Here is a list of a few of our recent graduates, the class of license they got, and how long it took them:

	License	Wks.
Anthony Giaquinta, 404 Dale Dr., Silver Spring, Md.	1st	12
J. Milton Condit, 1312 N. 78th Street, Seattle, Wash.	1st	8
Norman R. Cook, 130 Olive Street, Neodeska, Kan.	1st	12
Henry M. Best, 1003 Vermont Street, Fremont, N.C.	1st	11
James W. Reichard, 707 Arlington Street, Tamaqua, Pa.	1st	8
G. Carl Patschke, 3220 Conn. Ave., NW, Washington, D.C.	1st	12

MAIL COUPON TO SCHOOL NEAREST YOU

GRANTHAM SCHOOL OF ELECTRONICS • Desk 84-P
Washington • Hollywood • Seattle

Please send me your free booklet telling how I can get my commercial F. C. C. license quickly. I understand there is no obligation and no salesman will call.

Name _____ Age _____

Address _____

City _____ State _____

I am interested in: Home Study, Resident Classes

Hollywood Division

Washington Division

Seattle, Wash. Division

Grantham School OF ELECTRONICS

1505 N. Western Ave.
Hollywood 27, Calif. HO 2-1411

821 19th Street, N.W.
Washington 6, D.C. ST 3-3614



408 Marion Street
Seattle 4, Washington MA 2-7227



build what it takes
to get the best

high fidelity SOUND REPRODUCTION

IT TAKES THE FINEST OF COMPONENTS
—PRECISION JBL SIGNATURE LOUD SPEAKER UNITS—

		
THE D130 EXTENDED RANGE SPEAKER	THE 175DLH HIGH FREQUENCY ASSEMBLY	OR THE 075 HIGH FREQUENCY UNIT

—to get the best in high fidelity sound. And to get all of the rich, crisp, accurate, deep down bass generated by your D130, you must mount it in a carefully constructed, engineered acoustical enclosure. One of the most popular enclosures ever made, because of its compact dimensions and smooth, clean response, is the JBL Harkness Model C40—a back-loaded folded horn. Sound below 150 cps is radiated from the back of your D130 through the horn. Above 150 cps the speaker acts as a direct radiator. The six foot long, exponentially-flared horn path is ingeniously folded within sleek, low enclosure measuring only 38" wide. The horn is completely contained within the enclosure and is independent of room walls.

**BUILD YOUR
C40 FROM
PRODUCTION
PRINTS**

Prove your woodworking skill and get the greatest thrill high fidelity can give you. Here is a project that will make use of your finest craftsmanship for the enjoyment of yourself and your family—a project you can show off to others with pride. Detailed production prints, complete with a list of parts, and step-by-step instructions have now been released by the factory. The set is yours for only three dollars.



USE THIS FORM TO ORDER YOUR PLANS

JAMES B. LANSING SOUND, INC.
3249 Casitas Ave., Los Angeles 39, Calif.

Gentlemen: Enclosed find \$3.00 for one set of Model C40 Production Prints. Please print clearly or type your name and complete address.

Name _____
Address _____

Correspondence



ORIGINAL AC-DC CIRCUIT

Dear Editor:

I have recently had the opportunity of reading the interesting article "From Coherer to Spacistor" by T. R. Kennedy, Jr., which appeared in the Anniversary Issue of RADIO-ELECTRONICS [April, 1958]. I wish to congratulate Mr. Kennedy for writing such a comprehensive and complete article on the progress of electronics during the past 50 years.

Naturally, in preparing an article of such wide scope, there is always the possibility of omitting pertinent data. For this reason, I am writing to call your attention to the fact that in May, 1932, *Radio-Craft* published the first article ever to appear in print describing my original ac-dc circuit. I applied for the patent on this circuit on Feb. 12, 1932, and was awarded US Patent 2,086,256.

As mentioned in Mr. Kennedy's article, the first International Kadette ac-dc set containing the circuit of my invention did not appear in *Radio-Craft* until February, 1933, just 9 months later. Incidentally, the Kadette was *not* a three-way portable. This was a much later development, covered by my Patent 2,280,630.

Getting back to the ac-dc circuit, after a number of years of litigation, the validity of my patent was established and RCA, AT&T and other users of the ac-dc circuit became licensees of it.

Amagansett, N. Y. HARRY G. CISIN

GOLD IN THE STICKS

Dear Editor:

Fifteen years ago I moved from Chicago to Miami, Fla., to start a radio repair business. I was a big-city boy. I believed to get business, you had to go where business is—a big city.

I operated in Miami for about 6 years. I was moderately successful in getting my share of business. We opened at 8:00 am and closed at from 9-10:30 pm. Sure, we took Sundays off, in spite of the fact that many of our competitors did not. We were plutocrats.

I remember at that time my telephone ad ran about \$25 a month. I drove as far as 20 miles on a service call—all stop-and-go city driving. When I put an ad in the local paper, it covered a city of 200,000 souls scattered all over Hell's Half-acre. The ad was so costly that I could not afford to turn down a customer no matter how far away he was.

The big day came when a tourist walked into my store, and I graciously sold out to him at a nice profit.

you learn **MORE**
from a **SAMS BOOK**

IT'S A FACT:
proved by more than
1,000,000
SAMS BOOKS
bought to date

NEW BOOK RELEASE



"Servicing Hi-Fi and Associated Audio Equipment"

most complete service data available on popular make Hi-Fi components...

VOL. 1. Covers 26 models (power amplifiers, preamps, AM-FM tuners, P.A. amplifiers) produced during 1956-58. Includes section on planning, installing, maintaining hi-fi music systems. 160 pages, 8½ x 11". Only... \$2.95

VOL. 2. Covers 27 models of power amplifiers, preamps, AM-FM tuners, P.A. amplifiers produced in 1956-58. Special section on stereo music systems. Cumulative index. 160 pages, 8½ x 11". Only... \$2.95

CURRENT BEST SELLER



"TV Servicing Guide"

by Deane & Young
Written by technicians for technicians

Shows how to apply proper troubleshooting techniques based on an analysis of symptoms. Most trouble symptoms are illustrated by picture-tube screen photos and possible causes for each symptom are given. First chapter covers general troubleshooting and isolating procedure; remaining chapters treat each section of the receiver separately. 132 pages, 8½ x 11". Only... \$2.00

ORDER TODAY FROM YOUR SAMS DISTRIBUTOR OR MAIL COUPON

HOWARD W. SAMS & CO., INC.

Order from your Sams Distributor today, or mail to Howard W. Sams & Co., Inc., Dept. 2-J8 2201 E. 46th St., Indianapolis 5, Ind.

Send me the following books:

- "Servicing Hi-Fi", Vol. 1.
 "Servicing Hi-Fi", Vol. 2.
 "TV Servicing Guide", \$.....enclosed
 Send me your Free Book List

Name.....
Address.....
City.....Zone.....State.....

**WE'RE MAKING IT EASIER THAN EVER TO BECOME A WELL PAID
RADIO-TELEVISION SERVICE TECHNICIAN**

**NOW - Just \$6 Starts You Training in
RADIO-TELEVISION**

the SPRAYBERRY "Learn-by-Doing" Way . . .

**25 BIG, COMPLETE KITS
of PARTS & EQUIPMENT**

To help you learn *fast* the practical side of Radio-Television, we send you expertly engineered training kits to test and assemble for interesting, valuable shop-bench practice!

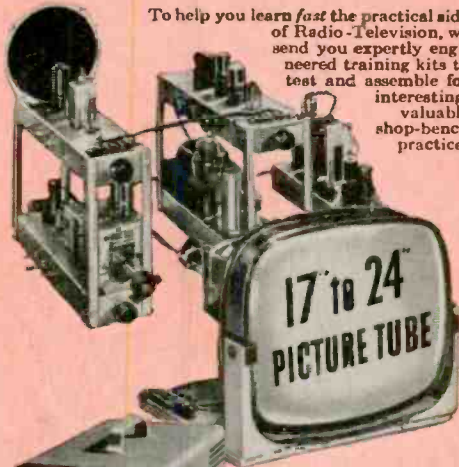

• The new Sprayberry Training Television Receiver built and tested in 5 sections.

• Now offered . . . this fine modern oscilloscope.

• You build this powerful two-band superheterodyne radio receiver.

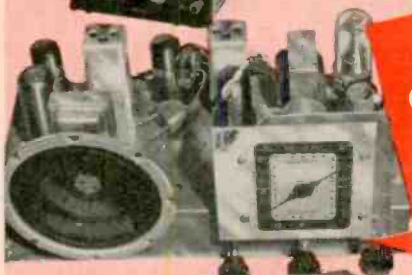

**Big New
CATALOG
AND
Sample Lesson
FREE!**



You build the new Sprayberry tester—a complete 18-range Volt-Ohm-Milliammeter test meter.

★ ★ ★ ★ This great industry is begging for trained men . . . to step into good paying jobs or a profitable business of their own! Our new plan opens the doors of Radio-Television wide to every ambitious man who is ready to act at once!

Men by the thousands . . . trained Radio-Television Service Technicians . . . are needed at once! Perhaps you've thought about entering this interesting, top paying field, but lack of ready money held you back. Now—just \$6 enrolls you for America's finest, most up to date home study training in Radio-Television! Unbelievable? No, the explanation is simple! We believe Radio-Television *must* have the additional men it needs as quickly as possible. We are willing to do our part by making Sprayberry Training available for less money down and on easier terms than ever before. This is your big opportunity to get the training you need . . . to step into a fine job or your own Radio-Television Service Business.

Complete Facts Free—Act Now; Offer Limited

Only a limited number of students may be accepted on this liberal and unusual basis. We urge you to act at once . . . mail the coupon below and get complete details plus our big new catalog and an actual sample lesson—all free. No obligation . . . no salesman will bother you.

HOME STUDY TRAINING IN SPARE TIME

Under world-famous 27-year old Sprayberry Plan, you learn entirely at home in spare time. You keep on with your present job and income. You train as fast or as slowly as you wish. You get valuable kits of parts and equipment for priceless shop-bench practice. And everything you receive, lessons and equipment alike, is all yours to keep.

LET US PROVE HOW EASILY YOU CAN LEARN!

Radio-Television needs YOU! And Sprayberry is ready to train you on better, easier terms, that any ambitious man can afford. *Just \$6 starts you!* Mail coupon today . . . let the facts speak for themselves. You have everything to gain. Let us prove the kind of opportunity that's in store for you!

SPRAYBERRY Academy of Radio-Television
1512 Jarvis Avenue, Dept. 20-L, Chicago 26, Illinois

Mail This Coupon Now—No Salesman Will Call

Sprayberry Academy of Radio-Television
Dept. 20-L, 1512 W. Jarvis Ave., Chicago 26, Ill.
Please rush all information on your ALL-NEW Radio-Television Training Plan. I understand this does not obligate me and that no salesman will call upon me. Include New Catalog and Sample Lesson FREE.

NAME..... Age.....

ADDRESS.....

CITY..... ZONE..... STATE.....



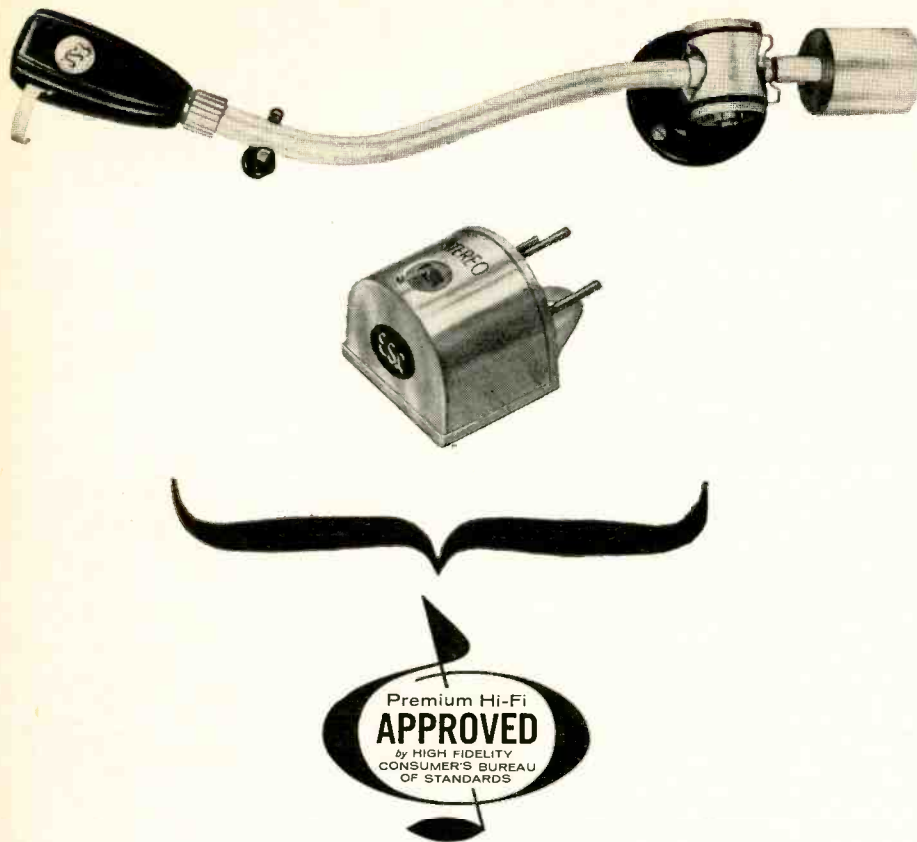

The only stereo cartridge and arm

approved by High Fidelity Consumer's Bureau of Standards

- ▶ The independent, bias-free High Fidelity Consumer's Bureau of Standards has established rigid performance standards against which all equipment must be tested before the Bureau's official Seal of Approval can be given.
- ▶ The triumphant new ESL GYRO/JEWEL stereo cartridge and GYRO/BALANCE stereo arm are the only true high-performance stereo components approved by the High Fidelity Consumer's Bureau of Standards at this time. The ESL C-60 Series cartridge, for matchless monophonic reproduction, also enjoys the Bureau's distinctive Seal of Approval.
- ▶ Here's why the best costs less: Inferior or makeshift stereo products all too soon may require replacement. No need to buy one substandard component after another, when a single purchase can bring you the superlative new ESL stereo cartridge and arm, years ahead in design and long-lasting in construction.
- ▶ In addition, the ESL GYRO/JEWEL (only \$69.95) and GYRO/BALANCE (only \$34.95) will more than save their own cost by greatly extending the life of valuable records and styli. Economize today with ESL—the perfectionist stereo equipment of tomorrow!



FOR LISTENING AT ITS BEST
Electro-Sonic Laboratories, Inc.
 Dept. E • 35-54 Thirty-sixth Street • Long Island City 6, N.Y.

CORRESPONDENCE (Continued)

The next problem—where to go and what to do? I had always dreamed of living on the Florida keys. School was just about out; so I suggested we move to the keys for the summer. My wife and kids were all for it; so we took a run down to look things over. I counted TV antennas from Homestead, which is at the north end of the keys, to the toll bridge. There were 59 antennas, just not enough to make a living on. Well, I wanted a vacation. I had a few dollars, and so I set up a shop on wheels in a large truck and I figured I would fix a set or two, maybe a few radios, and have a lot of time to fish and swim for 3 months. How wrong I was!

We moved into our apartment at 7:00 pm Saturday. At 8:00 am Sunday we started downstairs to go swimming. The Gulf of Mexico was in our backyard. On the way down a man hollered at me, "Are you the new TV man?" I assured him I was. He wanted service right then. I told him it was Sunday, and I was going swimming and I would fix him up the next day. He said, "Go on and swim—I'll wait for you," and he did. He sat on the dock until I got tired of seeing him, so I went to fix his set. I repaired seven sets that day in my bathing trunks, and never caught up on my work for the 3 months I was there.

I taught my landlord the TV service business during the 3 months and then sold him the business. It was one of the best 3 months we ever spent, financially and pleasure-wise.

I now avoid big cities and little cities, and look for the woods where everyone, myself included, is sure there is no business. It will amaze you—but, brother, it is there! Do a good job, and you can live an easy, pleasant and profitable life in the sticks, on an island or in the woods. Try it!

CARROLL S. SHAW
 Fort Myers Beach, Fla.

SQUARE-WAVE GENERATOR

Dear Editor:

I note in the June RADIO-ELECTRONICS an article entitled "Square-Wave Generator" (page 92). Apart from some changes in the output circuit, this is virtually identical to the circuit I developed several years ago, which was published in the July, 1952, *Wireless World* (London) and later in *Radio Laboratory Handbook*. I would therefore like to comment on its operation and on the values of certain resistors in your article.

The circuit relies on the amplitude being kept small in order to maintain a balanced waveform. The plate square wave is differentiated by the grid time constant and the amplitude is such that *no grid current flows*. The grid waveform is therefore balanced about ground potential.

Amplitude is kept low by a low-value plate load and, as this also determines rise and fall time, this is desirable. In your article, you give this as 47K, whereas my value was 4.7K. [Incidentally, your diagram is wrong in that it

Learn TELEVISION-RADIO

**Servicing or Communications
by Practicing at Home in Spare Time**



NRI gives you kits to build these and other equipment

Electronic Technicians Have High Pay, Prestige Jobs

People look up to and depend on the Technician, more than ever before. His opportunities are great, and are increasing. Become a Radio-Television-Electronic Technician. At home, and in your spare time, you can learn to do this interesting, satisfying work—quality for important pay. A stream of new Electronics products is increasing the job and promotion opportunities for Television-Radio-Electronic Technicians. Right now, a solid, proven field of opportunity for good pay is servicing the millions of Television and Radio sets now in use. The hundreds of Television and Radio stations on the air offer interesting jobs for Operators and Technicians. The military services reward qualified Technicians with higher rank and pay. Police, Aviation, Mobile Two-Way Radio are expanding. To ambitious men everywhere: here is rich promise of fascinating jobs, satisfaction and prestige, increasing personal prosperity.

Make Extra Money Soon, \$10 to \$15 a Week in Your Spare Time

NRI students find it practical and profitable to start fixing sets for friends and neighbors a few months after enrolling. Picking up \$10, \$15 and more a week gives substantial extra spending money. Use the Tester built with parts NRI furnishes, to locate and correct Radio-TV receiver troubles. Many who start in spare time, soon build full time Television-Radio sales and service businesses; others enjoy profitable spare time businesses and the security of a source of income to fall back on in case of layoffs, hard times or other changes in regular job. Postage free card will bring you complete facts about the NRI tested way to better pay.

NRI Has Trained Thousands for Successful Careers in TV-Radio



Studio Engr., Station KATV
"I am now Studio Engineer at Television Station KATV. Before enrolling for the NRI Course, I was held back by limitation of a sixth grade education." **BELLY SANCHEZ**, Pine Bluff, Ark.



Has All the Work He Can Do
"Since finishing NRI Course I have repaired more than 2,000 TV and Radio sets a year. NRI training certainly proved to be a good foundation." **H. R. GORDON**, Milledgeville, Ga.



Has Good Part Time Business
"Quite early in my training I started servicing sets. Now have completely equipped shop. My NRI training is the backbone of my progress." **E. A. BREDA**, Tacoma, Wash.

Cut Out and Mail Postage-Free Card NOW

Sample Lesson and Catalog Both FREE

SEE OTHER SIDE

How Electricity is Produced for Electronics

National Radio Institute
OLDEST & LARGEST HOME STUDY RADIO-TV SCHOOL
Dept. C, Washington 16, D.C.

Please send me sample lesson of your Radio-Television Training and Catalog FREE. (No salesman will call.)

Name..... Age.....

Address.....

City..... Zone..... State.....

ACCREDITED MEMBER NATIONAL HOME STUDY COUNCIL



ACT NOW FIND OUT WHAT NRI OFFERS YOU

NRI SUPPLIES LEARN-BY-DOING KITS WITHOUT EXTRA CHARGE
Technical Know-How Pays Off in Interesting, Important Work



YOU BUILD AC-DC Superhet Receiver

NRI Servicing Course includes all needed parts. By introducing defects you get actual servicing experience practicing with this modern receiver. Learn-by-doing.



YOU BUILD This 17 Inch Television Receiver

As part of your NRI course you can get all components, tubes, including 17" picture tube, to build this latest style Television receiver; get actual practice on TV circuits.

YOU BUILD Broadcasting Transmitter

As part of NRI Communications Course you build this low power Transmitter, learn commercial broadcasting operators' methods, procedures. Train for your FCC Commercial Operator's License.

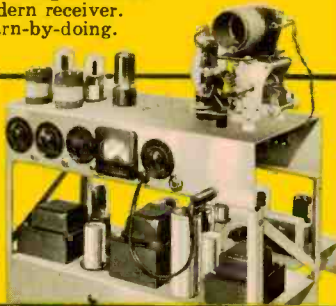

YOU BUILD Vacuum Tube Voltmeter

Use it to earn extra cash fixing neighbors' sets; bring to life theory you learn from NRI's easy-to-understand texts.



For Higher Pay, Better Jobs
Be a TV-Radio-Electronic Technician



Servicing Needs More Trained Men

Portable TV, Hi-Fi, Transistor Radios, Color TV are making new demands for trained Technicians. Good opportunities for spare time earnings or a business of your own.



J. E. Smith, Founder

Train at Home the NRI Way Famous for Over 40 Years

NRI is America's oldest and largest home study Television-Radio school. The more than 40 years' experience training men for success, the outstanding record and reputation of this school—benefits you in many ways. NRI methods are tested, proven. Successful graduates are everywhere, from coast to coast, in small towns and big cities. You train in your own home, keep your present job while learning. Many successful NRI men did not finish high school. Let us send you an actual lesson, judge for yourself how easy it is to learn.

Broadcasting Offers Satisfying Careers

4000 TV and Radio stations offer interesting positions. Govt. Radio, Aviation, Police, Two-Way Communications are growing fields. Trained Radio-TV Operators have a bright future.



No Experience Necessary—NRI Sends Many Kits for Practical Experience

You don't have to know anything about electricity or Radio to understand and succeed with NRI Course. Clearly written, well-illustrated NRI lessons teach TV-Radio-Electronic principles. You get NRI kits for actual experience. All equipment is yours to keep. You learn-by-doing. Mailing the postage-free card may be one of the most important acts of your life. Do it now. Reasonable tuition. Low monthly payments available. Address: NATIONAL RADIO INSTITUTE, Washington 16, D. C.

NRI Graduates Do Important Work



Now Quality Control Chief
 "Had no other training in Radio before enrolling, obtained job working on TV amplifiers before finishing course. Now Quality Control Chief." T. R. FAVAROLO, Norwich, N. Y.

NRI Course Easy to Understand
 "I opened my own shop before receiving my diploma. I have had to hire extra help. I am independent in my own business." D. P. CRESSEY, Stockton, Cal.

Works on Color-TV
 "NRI changed my whole life. If I had not taken the course, probably would still be a fireman, struggling along. Now Control Supervisor at WRCA-TV." J. F. MELINE, New York, N. Y.

FIRST CLASS
 Permit No. 20-R
 (Sec. 34.9, P. L. & R.)
 Washington, D.C.

BUSINESS REPLY CARD

No Postage Stamp Necessary if Mailed in the United States

POSTAGE WILL BE PAID BY

NATIONAL RADIO INSTITUTE
 3939 Wisconsin Avenue
 Washington 16, D.C.

SAMPLE LESSON
64-page CATALOG
both FREE

SEE OTHER SIDE

**FAST!
ACCURATE!**

SECO Test Equipment

**Saves time . . . makes
more money for you!**

WRITE TODAY FOR COMPLETE
SPECIFICATIONS AND FEATURES!

- Outstanding Reliability and Performance!
- Unique, Time-Saving Features!
- Low First Cost Makes You Money From the Start!

MODEL 107 TUBE TESTER—
Outstanding performance and accuracy—provides 3 important tests: amplifier types tested for gain by Dynamic Mutual Conductance method—power types tested for cathode current by Cathode Emission method—all types tested for shorts and grid error by Grid Circuit Test developed and patented by Seco. Dynamic Mutual Conductance Test pre-wired to eliminate elaborate set-up. Cathode Emission Test done by free point pin-selector method—will not be obsolete. Completely self-contained in portable carrying case. Furnished with handy flip chart for fast tube set-up data.



MODEL 107 \$139.50 NET



GCT-8 GRID CIRCUIT TUBE TESTER—Perfect companion to any tester—checks critical "control grid" condition of vacuum tubes fast, accurately. Electron eye tube indicates faults at a glance. As many as eleven simultaneous checks—automatically.

MODEL GCT-8—Kit \$19.95 NET

MODEL GCT-8—Wired & tested 29.95 NET



208VTVM—"Fool-proof"—many new features! Easy-to-read 4½" 200 microamp meter mounted on sloping panel—7 DC, 7 AC, 7 ordinary Ohm ranges, plus RETMA (EIA) Ohm scale to check standard color-coded resistance values and tolerance limits.

Specialty designed "Shift-lever" type function switch identifies and automatically connects proper probe. With stand, 40" leads, and common lead with clip.

MODEL 208 \$74.50 NET

Leather, felt-lined carrying case. **\$9.95 NET**



PS-2 BATTERY ELIMINATOR—Compact unit takes place of battery normally used to operate and service low-powered transistorized equipment. Supplies clean, filtered DC—can't be damaged by a short. Quickly spots faulty batteries by substitution. Output continuously variable from 0 to 15 V.—Ideal for experimenters. Complete with jacks, leads, and clips.

MODEL PS-2 \$13.95 NET

FB-4 FLYBACK CIRCUIT AND INDUCTANCE ANALYZER—Quick "yes" or "no" answer on condition of flyback transformer and yoke—100% accuracy! Resonant frequency and "Q" meter principle used—will not be obsolete. No disconnecting—no charting—checks complete horizontal coil circuit. Complete with self-contained power supply and matched 18" leads.

MODEL FB-4 \$38.95 NET

FP-1 FILAMENT CONTINUITY CHECKER AND 90 VOLT BIAS SUPPLY PACK—Checks continuity of TV and radio-type tubes—perfect for many bias substitution jobs.

MODEL FP-1 \$12.95 NET

Get the complete story on Seco's exciting line of test equipment. See your distributor—or write for complete information today!

SECO MANUFACTURING CO.



**5015 Penn Avenue So.
Minneapolis, Minn.**

CORRESPONDENCE (Continued)

shows R3 (47K) connected to the wrong side of C6 (0.1 uf).]

The grid resistor should always be much higher than the plate load, so that it never appreciably shunts the load resistor. If this is not so, the amplitude will vary at various frequency settings, and also the 50-50 balance may be upset. I used 39K as the fixed grid limit resistor, about eight times the plate load value. If your value of 3.9K is used, then there will be amplitude variation. As your quoted frequency ranges are approximately similar to mine, I would imagine it should have been 39K.

Use of a high value of amplitude control such as 500K is not advisable. At mid-settings its series resistance together with stray capacitance forms a low-pass filter which increases rise and fall times. This stray capacitance is lessened somewhat by cathode feedback in the output stage, but not sufficiently for consistent rise and fall times at different amplitude settings.

S. F. SINFIELD

Suton, Bedfordshire, England

TVI AND THE LAW

Dear Editor:

I have read several articles about correcting TV and radio interference and feel that it should be unnecessary for half a dozen hi-fi or TV owners to go through the expense of having the interference checked by some one and then the further expense of having to buy filters to correct it.

It seems to me that instead of six people putting out money, the owner of the defective or malfunctioning TV, etc., should have to correct it by law.

In this city there are a great number of companies using electronic sealing machinery; perhaps there are about 200 machines or more. The government required them to enclose all their machinery in screen rooms because of a radar installation less than a mile away. This I think illustrates the point:

The Government did not try to block the interference at the installation, but rather at the source—at the machine owners' expense. Therefore why shouldn't the owner of any machine creating severe TV or radio disturbance be made to spend his money correcting it, instead of making his neighbors pay for installing filters?

Newburg, N. Y.

JOHN DAGION

FOR ANTIQUE COLLECTORS

Dear Editor:

I have a collection of old radios and phonographs, which includes about 20 radios of 1926-37 vintage and 10 phonographs from a 1913 Edison to a 1920 model. Most of the sets are not in operating condition because of minor troubles or missing parts.

I am interested in selling these for what I paid for them—50 cents to \$5 apiece. In fact, some I would give away to a collector who is interested.

JAMES POSTON

1024 E. McPherson St., Kirksville, Mo.

END

FREE!

all-steel file cabinets
with your purchase of

PHOTOFACT

the world's finest TV-Radio Service Data



**FREE FOR REGULAR
PHOTOFACT SUBSCRIBERS**

You get these valuable File Cabinets ABSOLUTELY FREE from Howard W. Sams if you are a regular subscriber to PHOTOFACT and buy each Set as issued monthly . . .

**FREE FOR PHOTOFACT
LIBRARY PURCHASERS**

You get FREE File Cabinets as you complete your profit-building PHOTOFACT Library. . . What's more, you can own the PHOTOFACT Library the new Easy-Buy way. Here's how . . .

NEW EASY-BUY PLAN

No interest. No carrying charge. As little as \$10 down. Up to 24 months to pay. And Howard W. Sams will give you absolutely free all the steel file cabinets you'll need for your Library: Single-Drawer File Cabinet worth \$8.95 with your purchase of 60 Sets of PHOTOFACT Folders; Two single-drawer File Cabinets worth \$17.90 with your purchase of 120 Sets; Three single-drawer File Cabinets worth \$26.85 with your purchase of 180 Sets; Four single-drawer File Cabinets worth \$35.80 with your purchase of 240 Sets.

Take advantage of this money-saving opportunity. See your Sams Distributor today, or write to Howard W. Sams . . .

GET THE FULL DETAILS

HOWARD W. SAMS & CO., INC.

2205 E. 46th St., Indianapolis 5, Indiana

Send me full details on your FREE File Cabinet offer and EASY-BUY Plan.

I'm a Service Technician: full time; part time

My Distributor is:

Shop Name:

Attn.:

Address

City

Zone

State

City

Zone

State

see what's new in electronic kits...



SEE THEM IN ALLIED'S 1959 CATALOG...THE WORLD'S

FREE send for it!

typical **knight-kit** values . . . see these and dozens of



knight-kit Stereo Adapter Control Kit Model Y-778 **\$9⁹⁵**

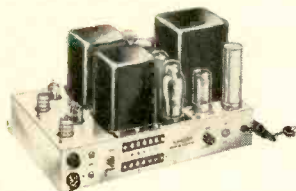

knight-kit 60-Watt Stereo Hi-Fi Amplifier Kit Model Y-777 **\$84⁵⁰**



knight-kit "Space Spanner" 2-Band Receiver Kit Model Y-259 **\$18⁹⁵**



knight-kit Stereo Deluxe Preamp Kit Model Y-776 **\$62⁵⁰**

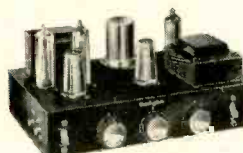

knight-kit 12-Watt Hi-Fi Amplifier Kit Model Y-784 **\$19⁹⁵**



knight-kit "Ranger III" AC-DC Radio Kit Model Y-736 **\$16⁹⁵**



knight-kit "Span-Master" 4-Band Receiver Kit Model Y-258 **\$24⁹⁵**



knight-kit "Ranger" Clock-Radio Kit Model Y-737 **\$24⁹⁵**



knight-kit "Ranger" Radio-Intercom Kit Model Y-739 **\$27⁵⁰**

EASY TERMS AVAILABLE ON knight-kit ORDERS AS LOW AS \$20



there's a money-saving **knight-kit**

SEE PAGE AFTER PAGE OF FASCINATING KITS, INCLUDING:

HI-FI KITS

- 18-Watt Amplifier
- 30-Watt Amplifier
- FM-AM Tuner
- FM Tuner
- Hi-Fi Preamplifier
- 25-Watt Basic Amplifier
- 2-Way Speaker Systems
- 3-Way Speaker Systems

HOBBY KITS

- Printed Circuit Radio
- "Ocean-Hopper" Radio
- 5-Transistor Portable
- 2-Transistor Pocket Set
- Transistor Lab Kit
- 1-Transistor Radio
- 2-Way Intercom
- Photoelectronic System
- Crystal Receiver
- Wireless Broadcaster
- Electronic Photoflash

INSTRUMENT KITS

- 5" Oscilloscopes
- Vacuum Tube Voltmeter
- Tube Testers
- Volt-Ohm-Milliammeters
- RF Signal Generator
- Signal Tracer
- Audio Generator
- Sweep Generator
- Capacitor Checker
- R/C Tester

ALLIED RADIO

see the outstanding 1959 **knight-kits**

AN ALLIED RADIO PRODUCT

LEADING ELECTRONIC SUPPLY GUIDE

other EASY-TO-BUILD kits



knight-kit Amateur Communications Receiver... Model Y-726 \$104.50



knight-kit "400" Tube Checker Kit Model Y-707 \$19.95

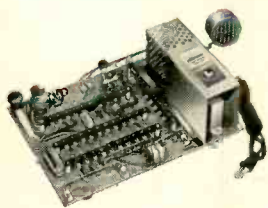

knight-kit 12-in-1 Electronic Lab Kit Model Y-272 \$14.95



DO-IT-YOURSELF
WITH QUALITY
knight-kits
SAVE UP TO 50%

LOWEST IN COST: ALLIED'S giant buying power passes biggest savings on to you—you do the easy assembly yourself and your finished equipment equals the performance, appearance and quality of factory-built units selling for several times the low KNIGHT-KIT price. You save most with KNIGHT-KITS.

EASIEST TO BUILD: KNIGHT-KIT "Step-and-Check" instruction manuals with wall-sized picture diagrams are marvels of clarity—it's like having a good instructor at your side, guiding you every step of the way. You don't have to be an "expert" to enjoy building a KNIGHT-KIT; all parts are clearly marked and identified; wires are pre-cut to size, stripped and colored for easy proper use; printed circuitry and printed-circuit switches eliminate complex wiring. You'll have only the highest praise for KNIGHT-KIT ease of assembly. You'll be proud of your work.

LATEST DESIGN: We design the latest circuitry into our KNIGHT-KITS to achieve top-quality performance. We field-test each kit to assure perfection. We apply quality control standards to every step of our kit manufacturing process. Tried and proved professional design, precise manufacturing skill and premium quality parts help to insure your building success.

THE KITS WITH THE MONEY-BACK GUARANTEE

EASY TERMS ON ORDERS OF \$20 OR MORE

for every need

- Transistor Checker
- Flyback Checker
- R/C Substitution Boxes
- Voltage Calibrator
- Battery Eliminator

AMATEUR KITS

- 50-Watt Transmitter
- Self-Powered VFO
- 100 kc Crystal Calibrator
- RF "Z" Bridge
- Code Practice Oscillator

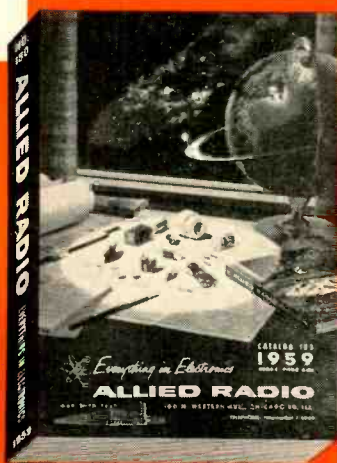

the world's largest
electronic supply house

FREE send for the 452-page
1959 ALLIED CATALOG

Send for the value-packed 1959 ALLIED Catalog featuring the complete KNIGHT-KIT line. See this leading Buying Guide for everything in Electronics. Write for your FREE copy today.

ALLIED RADIO CORP., Dept. 132-J8
100 N. Western Ave., Chicago 80, Ill.
 Send FREE ALLIED 452-Page 1959 Catalog

Name _____
Address _____
City _____ Zone _____ State _____

Our 38th Year



TECHNOLOGICAL CENTER

22nd and Lehigh Ave.
Philadelphia 32, Pa.

NAME _____
COMPANY & POSITION _____
ADDRESS _____
CITY _____ STATE _____

It's Here! The First **AMPLIFIED** PLUG-IN TV-FM HOME SYSTEM

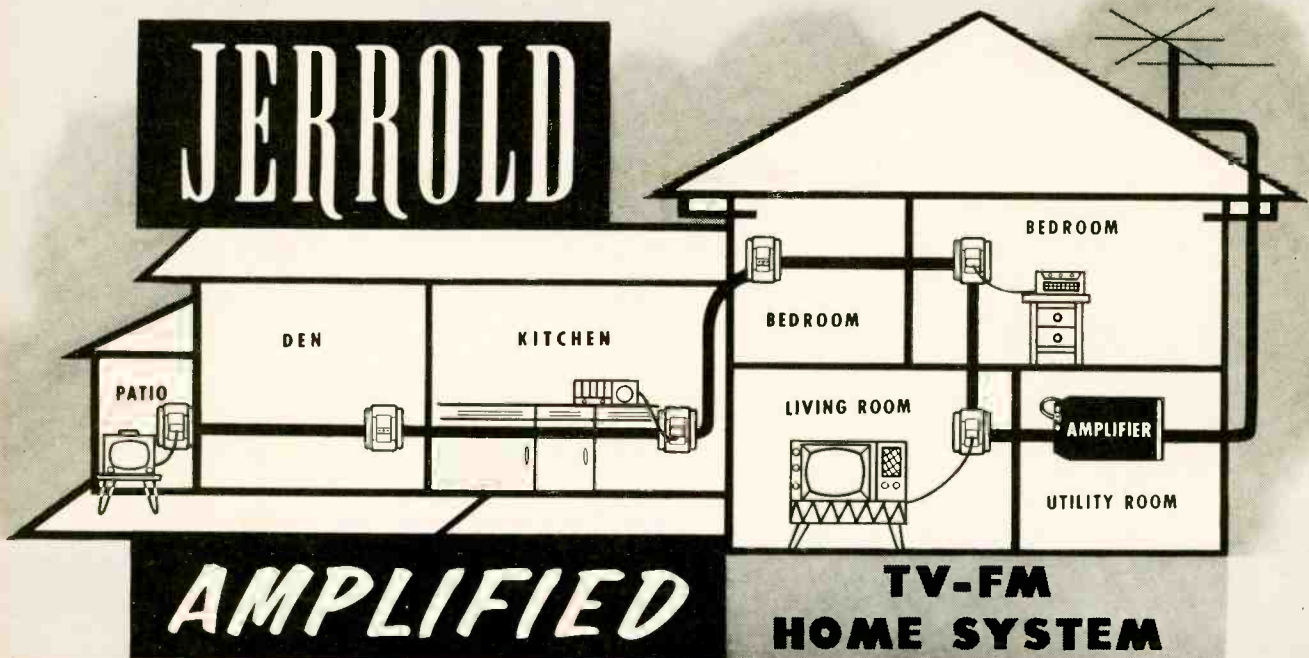

- * A Completely Engineered, Fully Amplified System — Not a Multi-Set Booster
- * Simple...Solderless...300 Ohm Twin-Lead Installation
- * Sets not "Tied Down", can be moved anywhere
- * "Snow Free" TV and "Hiss Free" FM Reception

The FIRST truly engineered, amplified system designed for the home! Supplies *Hi Fidelity* reception to TV and FM receivers in any room! Makes TV sets truly portable... new TV and FM receivers can be added with a simple plug-in connection!

The Jerrold Home System features a low noise, high output, printed circuit amplifier that increases the TV and FM antenna signals 6 times (15 db). 300 ohm Twin-Lead is used to distribute the amplified signal throughout the home. Receivers are connected to the system by newly designed Home Outlets and Plugs.

The Jerrold Home System opens up a whole new market for the serviceman. It enables him to provide better TV and FM reception in any signal location.

For complete details contact your Jerrold distributor or write to Dept. PD 81

JERROLD

ELECTRONICS CORPORATION

The Jerrold Building, 15th & Lehigh, Philadelphia 32, Pa.

Jerrold Electronics Corp., Ltd., Toronto, Canada • Export Representative, CBS International, New York 22, New York

LOOK TO JERROLD FOR AIDS TO BETTER TELEVIEWING

HOME SYSTEM COMPONENTS

HOME AMP... MODEL HSA-46



The 1st printed Circuit TV-FM amplifier. Greatly improves weak signals; flat response across entire (VHF) TV-FM band. Only 2 tubes, designed for 24-hr. operation, consumes only 18 watts. Color compatible, UL approved.

\$4995 LIST

◀ FLUSH OUTLET... MODEL HSA-140

\$275 LIST



SURFACE OUTLET... MODEL HS-135 ▶

\$195 LIST

The outlets supply clear strong signals without interference between sets. Each includes Perma-Grip plug for TV or FM. Color: Ivory.



No Trimming of Wire Necessary... No Soldering! Quick Screwdriver Installation.

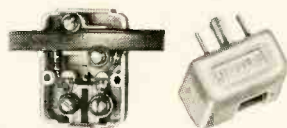

ALSO AVAILABLE in ready-to-install kit form

Home System Kit Model HSK-300

Contains everything (except antenna) for complete 5 outlet system—including Twin-Lead.

\$6775 LIST

For Installation in New Homes and Existing Homes.

free!

ALLIED'S 1959

value-packed 452-page ELECTRONIC SUPPLY CATALOG

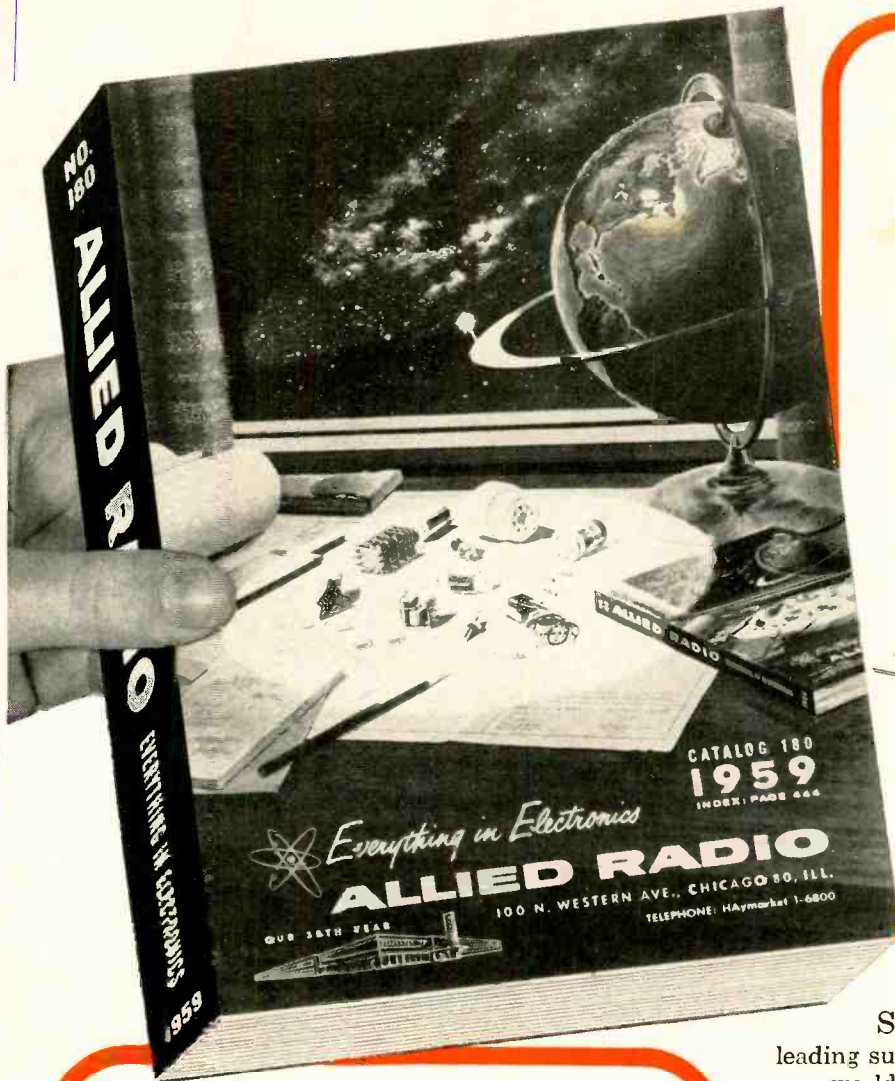

the only COMPLETE guide
to everything in electronics

WORLD'S LARGEST STOCKS

- Latest Stereo Hi-Fi Systems— Everything in Hi-Fi Components
- Money-Saving, Build-Your-Own KNIGHT-KITS—Latest Models
- Values in Recorders and Supplies
- Latest Public Address Systems, Paging and Intercom Equipment
- Amateur Receivers, Transmitters and Station Gear
- Test & Laboratory Instruments
- Specialized Electronic Equipment for Industrial Application
- TV Tubes, Antennas, Accessories
- Huge Listings of Parts, Tubes, Transistors, Tools, Books

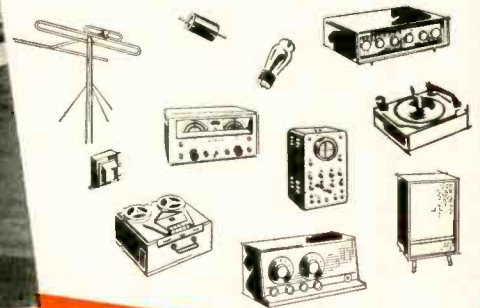

featuring:

MONEY-SAVING knight-kits: Finest electronic equipment in money-saving kit form. Complete selection of latest Hi-Fi amplifier, tuner and speaker kits (new Stereo units); Hobbyist kits; Test Instruments and Amateur kits. KNIGHT-KITS are an exclusive ALLIED product.

HI-FI! STEREO! See the world's largest selection of quality Hi-Fi music systems and famous name components. First with the latest in STEREO! Save on ALLIED-recommended complete systems. Own the best in Hi-Fi for less!

EASY PAY TERMS: Only 10% down; available on orders of \$20 or more. Fast handling—no red tape.

ALLIED RADIO



our 38th year
World's Largest Electronic Supply House

Send for ALLIED'S 1959 Catalog—it's the leading supply guide—452 pages packed with the world's largest selection of quality electronic equipment at lowest, money-saving prices. Get every buying advantage at ALLIED: fastest shipment, expert personal help, lowest prices, guaranteed satisfaction...

send for the leading
electronic supply guide



ALLIED RADIO CORP., Dept. 2-J8
100 N. Western Ave., Chicago 80, Ill.

Send FREE 452-Page 1959 ALLIED Catalog

Name _____

Address _____

City _____ Zone _____ State _____

Bell Laboratories Announces Pocket-Sized Frequency Standard for Microwave Systems



Lawrence Koerner, who developed the portable frequency standard, demonstrates how the device can be plugged in at a radio relay station to supply a checking frequency. Battery-powered, the device maintains precision calibration for several months.

Microwave radio relay systems depend critically on the accuracy of their "carrier" frequencies. At scores of relay stations along a route, carrier frequency oscillators must be checked periodically against a signal from a precise standard.

In the past, the maintenance man has had to obtain his checking frequency by picking up a standard radio signal from a government station. This operation takes time—and requires elaborate equipment.

With a new *portable* frequency standard developed by Bell Laboratories engineers, the job is much simplified. To check an oscillator, the portable standard is plugged in, and a button is pressed. In seconds, it supplies a checking frequency accurate to one part in a million.

Until now, such precision in a frequency standard has been obtainable only in a laboratory. The new portable standard makes it available for routine use in the Bell System. First use of the standard will be to maintain frequency control in a new microwave system for telephone and TV, now under development at Bell Laboratories.

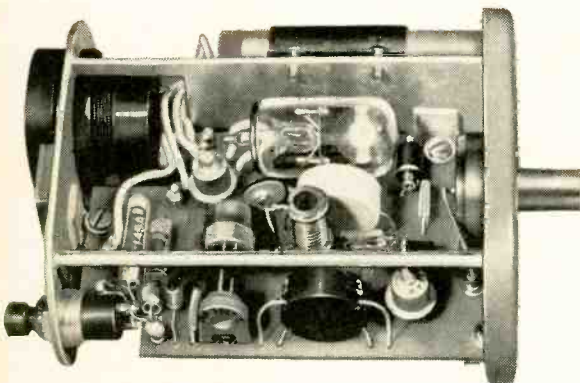

Inside the portable frequency standard. Four Laboratories-developed devices make it possible: (1) transistor, which converts the power from a battery to radio frequency oscillations; (2) voltage reference diode, which maintains constant voltage; (3) piezoelectric crystal unit of superlative stability; (4) thermistor, which corrects for temperature variations.



BELL TELEPHONE LABORATORIES

WORLD CENTER OF COMMUNICATIONS RESEARCH AND DEVELOPMENT

RADIO-ELECTRONICS

STEREO STEREO AND MONAURAL

the
experts
say...
in HI-FI
the best buys are



World-famous
EICO advantages
guarantee your complete satisfaction:

- Advanced engineering • Finest quality components
- "Beginner-Tested," easy step-by-step instructions
- LIFETIME service & calibration guarantee
- IN STOCK — Compare, then take home any EICO equipment—right "off the shelf"—from 1900 neighborhood EICO dealers. No mail delays, no high penalty freight costs



Stereo Preamplifier HF85



FM Tuner HFT90



Stereo Amplifier-Preamp HF81



Bookshelf Speaker System HFS1



Monaural Integrated Amplifiers: 50, 30, 20, and 12-Watt (use 2 for Stereo)



Speaker System HFS2
36" H x 15 1/4" W x 11 1/2" D



Monaural Power Amplifiers: 60, 50, 35, 30, 22 and 14-Watt (use 2 for Stereo)



Monaural Preamplifiers: HF65, HF61 (stack 2 for Stereo)



Over 1 MILLION EICO Instruments in use throughout the world.

STEREOPHONIC EQUIPMENT

HF85: Stereo Dual Preamplifier selects, preamplifies & controls any stereo source — tape, discs, broadcasts. Distortion borders on unmeasurable. Self-powered. Works with any 2 quality power amplifiers such as EICO HF14, HF22, HF30, HF35, HF50, HF60. Kit \$39.95. Wired \$64.95.

HF81: Stereo Dual Amplifier-Preamplifier selects, amplifies & controls any stereo source — tape, discs, broadcasts — & feeds it thru self-contained dual 14W amplifiers to a pair of speakers; complete stereo preamp. Ganged level controls, separate focus (balance) control, independent full-range bass & treble controls for each channel. Identical Williamson-type, push-pull EL84 power amplifiers, excellent output transformers. "Low silhouette" construction. Kit \$69.95. Wired \$109.95, incl. cover.

MONAURAL PREAMPLIFIERS (stack 2 for Stereo)

HF65: superb new design. Inputs for tape head, microphone, mag-phono cartridge & hi-level sources. 1M distortion 0.04% @ 2V out. Attractive "low silhouette" design. HF65A Kit \$29.95, Wired \$44.95. HF65 (with power supply) Kit \$33.95. Wired \$49.95.

HF61: "Rivals the most expensive preamps" — Marshall, AUDIOCRAFT. HF61A Kit \$24.95, Wired \$37.95, HF61 (with power supply) Kit \$29.95. Wired \$44.95.

MONAURAL POWER AMPLIFIERS (use 2 for STEREO)

HF60: 60-Watt Ultra Linear Power Amplifier with Acro TO-330 Output Transformer; wide band-width, virtually absolute stability & flawless transient response. "One of the best-performing amplifiers extant; an excellent buy." AUDIOCRAFT Kit Report. Kit \$72.95. Wired \$99.95. Matching Cover E-2 \$4.50.

HF50: 50-Watt Ultra Linear Power Amplifier with extremely high quality Chicago Standard Output Transformer. Identical in every other respect to HF60, same specifications at 50 watts. Kit \$57.95. Wired \$87.95. Matching Cover E-2 \$4.50.

HF35: 35-Watt Ultra-Linear Power Amplifier version of the HF60 above. Kit \$47.95. Wired \$72.95.

HF30: 30-Watt Power Amplifier employs 4-EL84 high power sensitivity output tubes in push-pull parallel, Williamson circuit, 20 db feedback, & high stability margin. 2-EZ81 full-wave rectifiers for highly reliable power supply. Unmatched value in medium-power amplifiers. Kit \$39.95. Wired \$62.95. Matching Cover E-3 \$3.95.

HF22: 22-Watt Power Amplifier version of the HF60 above. Kit \$38.95. Wired \$61.95.

HF14: 14-Watt Power Amplifier of the HF81 above. Kit \$23.50. Wired \$41.50.

MONAURAL INTEGRATED AMPLIFIERS (use 2 for STEREO)

HF52: 50-Watt Integrated Amplifier with complete "front end" facilities & Chicago Standard Output Transformer. Ultra-Linear power amplifier essentially identical to HF50. "Excellent value" — Hirsch-Houck Labs. Kit \$69.95. Wired \$109.95. Matching Cover E-1 \$4.50.

HF32: 30-Watt Integrated Amplifier combines excellent HF30 power amplifier above with versatile preamplifier featuring tape head & microphone inputs, scratch & rumble filters, all amplifier facilities. Kit \$57.95. Wired \$89.95. Both include cover.

HF20: 20-Watt Integrated Amplifier complete with finest preamp-control facilities, excellent output transformer that handles 34W peak power, plus a full Ultra-Linear Williamson power amplifier circuit. "Well-engineered" — Stocklin, RADIO TV NEWS. Kit \$49.95. Wired \$79.95. Matching Cover E-1 \$4.50.

HF12: 12-Watt Integrated Amplifier provides complete "front end" facilities & excellent performance for any medium-power application. "Packs a wallop" — POPULAR ELECTRONICS. Kit \$34.95. Wired \$57.95.

SPEAKER SYSTEMS (use 2 for STEREO)

HFS2: Natural bass 30-200 cps via slot-loaded 12-ft. split conical bass horn. Middles & lower highs: front radiation from 8 1/2" edge damped cone. Distortionless spike-shaped super-tweeter radiates omni-directionally. Flat 15 1/4", 11 1/2". "Remarkable illusion of realism eminently musical... would suggest unusual suitability for stereo application." — Holt, HIGH FIDELITY. Completely factory-built: Walnut or Mahogany. \$139.95; Blonde, \$144.95.

HFS1: Bookshelf Speaker System, complete with factory-built cabinet. Jensen 8" woofer, matching Jensen compression-driver exponential horn tweeter. Smooth clean bass; crisp extended highs. 70-12,000 cps range. Capacity 25 w. 8 ohms. HWD: 11" x 23" x 9". Wiring time 15 min. Price \$39.95.

FM TUNER

HFT90: surpasses wired tuners up to 3X its cost. Pre-wired, pre-aligned, temperature-compensated "front end" — drift-free. Precision "eye-tronic" tuning. Sensitivity, 1.5 uv for 20 db quieting — 6X that of other kit tuners. Response 20-20,000 cps ±1 db. K-follower & multiplex outputs. "One of the best buys you can get in high fidelity kits." — AUDIOCRAFT KIT REPORT. Kit \$39.95*. Wired \$65.95*. Cover, \$3.95.

*Less cover, F.E.T. incl.

BEFORE YOU BUY, COMPARE:

You may examine the complete EICO line at any of 1900 neighborhood EICO distributors coast to coast. Compare critically with equipment several times the EICO cost — then you judge. You'll see why the experts recommend EICO, kit or wired, as your best buy.

EICO, 33-00 NORTHERN BLVD., L.I.C. 1, N.Y.
Fill out coupon on other side for FREE CATALOG

Copyright 1958 by Electronic Instr. Co., Inc. 33-00 N. Blvd., L.I.C. 1, N.Y.

Add 5% in the West.

the specs prove it . . .
your **BEST BUY** is

EICO®

for COLOR & Monochrome TV servicing

FREE CATALOG

shows you **HOW TO SAVE 50%**
on 50 models of top quality
professional test equipment.
MAIL COUPON NOW!

SEE OUR "HAM" AD ON PAGE 113

NEW!
TV-FM SWEEP GENERATOR & MARKER #368



KIT \$69⁹⁵ WIRED \$119⁹⁵

Entirely electronic sweep circuit (no mechanical devices) with accurately-biased inductor for excellent linearity. Extremely flat RF output: new AGC circuit automatically adjusts osc. for max. output on each band with min. ampl. variations. Exceptional tuning accuracy: edge-lit hairlines eliminate parallax. Swept Osc. Range 3-216 mc in 5 fund. bands. Variable Marker Range 2-75 mc in 3 fund. bands; 60-225 mc on harmonic band. 4.5 mc Xtal Marker Osc., xtal supplied. Ext. Marker provision. Sweep Width 0-3 mc lowest max. deviation to 0-30 mc highest max. dev. 2-way blanking. Narrow range phasing. Attenuators: Marker Size, RF Fine, RF Coarse (4-step decade). Cables: output, 'scope horiz., 'scope vertical. Deep-etched satin aluminum panel; rugged grey wrinkle steel cabinet.

NEW! RF SIGNAL GENERATOR #324



KIT \$26⁹⁵ WIRED \$39⁹⁵

150 kc to 435 mc with ONE generator! Better value than generators selling at 2 or 3 times its cost! Ideal for IF-RF alignment, signal tracing & trouble-shooting of TV, FM, AM sets; marker gen.; 400 cps audio testing; lab. work. 6 fund. ranges: 150-400 kc, 400-1200 kc, 1.2-3.5 mc, 3.5-11 mc, 11-37 mc, 37-145 mc; 1 harmonic band 111-435 mc. Freq. accurate to ±1.5%; 6:1 vernier tuning & excellent spread at most important alignment freqs. Etched tuning dial, plexiglass windows, edge-lit hairlines. Colpitts RF osc. directly plate-modulated by K-follower for improved mod. Variable depth of int. mod. 0-50% by 400 cps Colpitts osc. Variable gain ext. amplifier: only 3.0 v needed for 30% mod. Turret-mounted coils slug-tuned for max. accuracy. Fine & Coarse (3-step) RF attenuators. RF output 100,000 uv; AF sine wave output to 10 v. 50-ohm output Z. 5-way jack-top binding posts for AF in/out; coaxial connector & shielded cable for RF out. 12AU7, 12AV7, selenium rectifier; xmfr-operated. Deep-etched satin aluminum panel; rugged grey wrinkle steel cabinet.

NEW! DYNAMIC CONDUCTANCE TUBE & TRANSISTOR TESTER #666

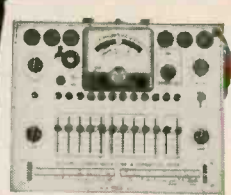

KIT \$69⁹⁵ WIRED \$109⁹⁵

COMPLETE with steel cover and handle.

SPEED, ease, unexcelled accuracy & thoroughness. Tests all receiving tubes (and picture tubes with adapter). Composite indication of Gm, Gp & peak emission. Simultaneous sel of any 1 of 4 combinations of 3 plate voltages, 3 screen voltages, 3 ranges of continuously variable grid voltage (with 5% accurate pot). New series-string voltages: for 600, 450, 300 ma types. Sensitive 200 ua meter. 5 ranges meter sensitivity (1% shunts & 5% pot). 10 SIX-position lever switches: freepoint connection of each tube pin. 10 pushbuttons: rapid insert of any tube element in leakage test circuit & speedy sel. of individual sections of multi-section tubes in merit tests. Direct-reading of inter-element leakage in ohms. New gear-driven rollchart. Checks n-p-n & p-n-p transistors: separate meter readings of collector leakage current & Beta using internal dc power supply. Deep-etched satin aluminum panel; rugged grey wrinkle steel cabinet. CRA Adapter \$4.50

COLOR and Monochrome DC to 5 MC LAB & TV 5" OSCILLOSCOPE #460



KIT \$79⁹⁵ WIRED \$129⁵⁰

• Features DC Amplifiers!

Flat from DC-4.5 mc, usable to 10 mc. VERT. AMPL.: sens. 25 rms mv/in; input Z 3 megs; direct-coupled & push-pull thruout; K-follower coupling bet. stages; 4-step freq-compensated attenuator up to 1000:1. SWEEP: perfectly linear 10 cps-100 kc (ext. cap. for range to 1 cps); pre-set TV V & H positions; auto. sync. ampl. & lim. PLUS: direct or cap. coupling; bal. or unbal. inputs; edge-lit engraved lucite screen; dimmer; filter; bezel fits std photo equipt. High intensity trace CRT. 0.06 usec rise time. Push-pull hor. ampl., flat to 400 kc, sens. 0.6 rms mv/in. Built-in volt. calib. Z-axis mod. Sawtooth & 60 cps outputs. Astig. control. Retrace blanking. Phasing control. 5" PUSH-PULL Oscilloscope = 425: KIT \$44.95, Wired \$79.95. 7" PUSH-PULL Oscilloscope = 470: KIT \$79.95, Wired \$129.50.

NEW! PEAK-to-PEAK VTVM #232 & UNI-PROBE (pat. pend.)



KIT \$29⁹⁵ WIRED \$49⁹⁵

Half-turn of probe tip selects DC or AC-Ohms. Uni-Probe - exclusive with EICO - only 1 probe performs all functions!

Latest circuitry, high sensitivity & precision, wide ranges & versatility. Calibration without removing from cabinet. New balanced bridge circuit. High Z input for negligible loading. 4 1/2" meter, can't burn-out circuit. 7 non-skip ranges on every function. 4 functions: +DC Volts, -DC Volts, AC Volts, Ohms. Uniform 3 to 1 scale ratio for extreme wide-range accuracy. Zero center. One zero-adj. for all functions & ranges. 1% precision ceramic multiplier resistors. Measure directly peak-to-peak voltage of complex & sine waves: 0-4, 14, 42, 140, 420, 1400, 4200. DC/RMS sine volts: 0-1.5, 5, 15, 50, 150, 500, 1500 (up to 30,000 v. with HVP probe & 250 mc with PRF probe). Ohms: 0.2 ohms to 1000 megs. 12AU7, 6AL5, selenium rectifier; xmfr-operated. Deep-etched satin aluminum panel, rugged grey wrinkle steel cabinet.

New!
Series/Parallel R-C COMBINATION BOX #1140



KIT \$13.95 WIRED \$19.95

TUBE TESTER #625



KIT \$34.95 WIRED \$49.95

- tests 600 ml series string type tubes
- illuminated roll-chart

Pix Tube Test Adapter \$4.50

6V & 12V BATTERY ELIMINATOR & CHARGER #1050

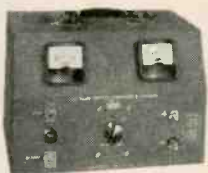

KIT \$29.95 WIRED \$38.95

Extra-filtered for transistor equipt.

#1060 KIT \$38.95 WIRED \$47.95

New!
Miniaturized MULTI-SIGNAL TRACER #145A



KIT \$19.95 WIRED \$28.95

20,000 Ohms/Volt V-O-M #666



KIT 24.95 WIRED \$29.95

1000 Ohms/Volt V-O-M #536

KIT \$12.90 WIRED \$14.90

R-C BRIDGE & R-C-L COMPARATOR #950B



Reads 0.5 ohms -500 megs, 10 mmfd-5000 mfd, power factor.

KIT \$19.95 WIRED \$29.95

VTVM PROBES

	KIT	Wired
Peak-to-Peak	\$4.95	\$6.95
RF	\$3.75	\$4.95
High Voltage Probe-1		\$6.95
High Voltage Probe-2		\$4.95

SCOPE PROBES

	KIT	Wired
Demodulator	\$3.75	\$5.75
Direct	\$2.75	\$3.95
Low Capacity	\$3.75	\$5.75

TURN PAGE FOR MORE EICO VALUES

EICO®

Send for **FREE CATALOG** now

Prices 5% higher on West Coast.

33-00 Northern Blvd., Long Island City 1, N.Y.

EICO, 33-00 Northern Blvd., Long Island City 1, N. Y. C-9

Show me **HOW TO SAVE 50%** on Test Instruments Hi-Fi Ham Gear. Send me **FREE** Catalog and name of neighborhood dealer.

Name.....
Address.....
City.....Zone.....State.....

IS MILITARY RADAR DOOMED?

... New Scientific Advances Change Our Concepts ...

A driving rain falling on a smooth, hard sidewalk rebounds from the surface in various directions. The same rain falling on desert sand is completely absorbed. Light rays falling on most substances are reflected in various directions. The same light falling on two Tourmaline crystal plates—crossed at right angles to each other—is completely extinguished. Light is electromagnetic. So is radar. Hence, ever since the advent of radar, science has occupied itself with devising means to prevent radar's high-frequency waves from bouncing back.

During World War II, British and US Air Forces used a number of schemes to prevent the enemy from determining the actual position of their bombers, particularly at night and during overcast. Bombers dropped long thin aluminum strips which gave a multiplicity of readings on the enemy's radar indicators, thus confusing his gunners.

Later, special paints and coverings were tried on various aircrafts to "insulate" them against radar. Similar ideas were tried on exposed conning towers and periscopes of submarines. None of these measures were too successful at the time.

Warfare throughout history has taught that every new war implement, in due time, will have a "counter." The bow and arrow was countered by the protective shield. The fortress was countered by destructive gunfire. Rifles and their bullets in the field were minimized by slit trenches. Tanks were annihilated by cannon and bazookas. A and H Bombs can be destroyed in flight by other A and H Bombs, *if they can be intercepted early enough.* This is true whether they are delivered via aircraft or intercontinental ballistic missile (ICBM).

The latter, speeding at the rate of 15,000 miles per hour, does not give the defender much time to locate and destroy it high up before it strikes a city or other target. Hence, efficient radar to search out the missile quickly and accurately is a paramount requirement.

Yet, scientists on both sides of the Iron Curtain have long been engaged in devising means to nullify radar long-distance detection of planes and missiles. If this can be done effectively, then theoretically, neither side will have a defense. Theoretically, also, if there were a 100% radar "insulator," both nations would be "naked" against ICBM attacks, hence both would be checkmated. This would be a perfect standoff, and for a time there would be an enforced, if jittery, peace.

Recent advances seem to point in this direction. Thus, Wright Air Development Command scientists have been successful in perfecting an anti-radar "paint" that greatly reduces radar detection of aircraft and missiles. Note particularly the term *reduce*—so far as is known, no known paint or substance *completely* insulates a moving craft against radar reflection. Yet a Government spokesman, according to *Science News Service*, states:

"There is every reason to believe the Russians are working on such paints and they just might even be ahead of us; . . . if they perfect anti-radar paints, what will happen to our Distant Early Warning system in Canada, and Texas Tower radar posts in the Atlantic?" He also hastened to add that existing and contemplated anti-radar paints even at their best could not completely hide a plane or missile from radar, but could only reduce the chances of discovery.

Anti-radar "paints" today, in reality, are extra heavy coatings. In their disfavor is a considerable weight. It is known that they are made of horse-hair or equivalent plastics impregnated with carbon (carbon black or soot) or of special rubber material bonded to ceramics or brass. This prevents the radar waves from bouncing back, because the material is supposed to absorb the waves—i.e., the electromagnetic energy. In this respect, it acts much as the tourmaline plates, discussed at the beginning of this article, when struck by light.

The comparatively new art of anti-radar devices is as yet too young to expect perfect results. Nevertheless, progress in a "hot" field such as this is inexorable. One would dwell in a fool's paradise if one counted on the belief that a near 100% anti-radar system would never come about. Indeed, in our opinion, near-perfection must be expected to be realized in the foreseeable future.

As in all war innovations, even a perfected anti-radar means will, in time, be countered. An absolute standoff has never lasted long in history.

We must not forget, either, that perfect anti-radar would prove a serious nuisance in many respects. Camouflaged enemy aircraft masquerading as our own *could not be reported by radar when approaching and crossing our borders.* They could fly unmolested over our country on reconnaissance missions at will, photographing our defense plants, etc. Enemy submarines, too, could make similar missions along our shores, particularly at night—if we had no other detecting means.

For these, and other, reasons, anti-radar devices must, in time, be counteracted. What will be such a "counter?" One answer will no doubt be the present more or less secret infra-red instrumentality.

As we ascend higher into the radio-frequency band, past the millimeter waves, we emerge into the infra-red spectrum, the quasi-optical range which we have termed in the past *electronoptics*. By using infra-red (or near infra-red) frequencies in our future radar and other detecting devices, it is quite possible that present and later anti-radar systems will prove to be useless. It is already known that infra-red frequencies have a number of advantages over present-day radar. Other inventions no doubt will be made to counter anti-radar developments—the electromagnetic spectrum still holds many future surprises.

—H. G.

the HI-FI AMPLIFIER ABROAD

Five amplifiers and one preamp, all European types, show the low-power approach to high fidelity

By A. V. J. MARTIN



THE EL84/6BQ5, that remarkable audio output tube, has been in common use in Europe for some years and a number of hi-fi amplifiers have been designed around it. The four circuits described here are typical of careful, well proven designs. Similarly, the high-power high-performance EL34/6CA7 is now commonly available and may form the basis of quality amplifiers delivering up to 100 watts (presumably the huskier European variety.—*Editor*) per pair of tubes. The circuit described has been conservatively designed and time-tested over several years.

A number of excellent output transformers are available in the US that

can be used with the circuits given.

Baxandall 5-watt amplifier

This circuit, developed by P. J. Baxandall, appeared in *Wireless World*, March, April and June 1957.

While the present trend is toward higher and higher power outputs, there will always be some interest in a small, simple unit capable of delivering a few clean watts of audio. Fig. 1 shows the circuit of such an amplifier. It uses only three tubes and a rectifier. The first half of an ECC81/12AT7 is used as a voltage amplifier and is followed by the second half of the same tube in a split-load circuit. This drives the out-

put transformer. This arrangement is rarely used because of its poor efficiency. However, it offers some very practical advantages from the viewpoint of distortion and, more important, ease of output transformer design—leakage inductances are much less critical.

The circuit has a number of interesting details that improve performance and stability. First, an overall feedback loop connects the 2.5-ohm output tap to the input cathode, providing 24 db of feedback. This brings the damping factor to about 20, reduces the apparent internal impedance to 0.7 ohm seen from the output and improves the response curve. Square-wave tests at 5,000 cycles show only a small overshoot.

The coupling between the first plate and second grid of the ECC81 is compensated for high frequencies. Three R-C circuits are connected to the output transformer: one across the 15-ohm secondary, and one across each half of the primary. The output tubes are separately biased by unbypassed cathode resistors. This introduces extra feedback and improves the linearity. Suppressor resistors in all control and screen grid circuits prevent parasitic oscillations.

The power supply is conventional and delivers 300 volts at 70 milliamperes. Note the grounded artificial center tap on the heater winding. The circuit in Fig. 1 requires a 4-volt rms signal input for 5 watts output. Sensitivity can be increased to develop the same output with only 1.4 volts input by connecting a 50- μ f 25-volt electrolytic across each output cathode resistor and by a minor modification in the feedback loop. Connect 180- and 100-ohm resistors in series between the 2.5-ohm output tap and

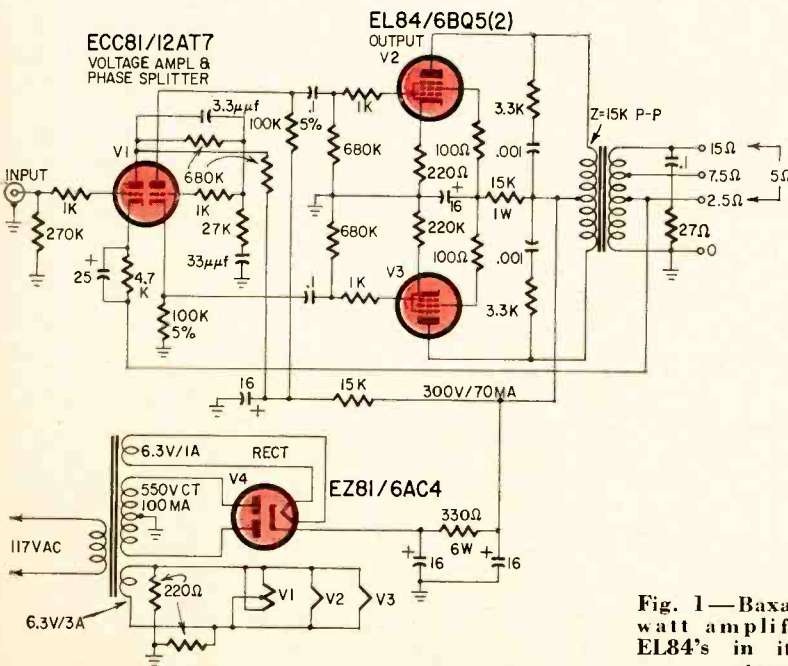

Fig. 1—Baxandall's 5-watt amplifier uses EL84's in its output stage.

ground—the 100-ohm resistor is on the ground end of the string. Connect the feedback line to the junction of the two resistors.

A 10-watt unit

This amplifier can probably be considered as being on the borderline of hi fi, mainly because of the small output transformer used. It was described by P. Romain in *Toute la Radio*, January, 1957, under the name ATR 212. Its circuit is in Fig. 2. It uses three tubes and a rectifier. The important voltages are indicated.

One half of a 12AU7 is used as a voltage amplifier. The other half has equal loads in its plate and cathode circuits and drives a pair of EL84's. The feedback loop connects the output transformer secondary to the input cathode through a resistance divider. The bias resistor of the second half of the 12AU7 is not decoupled.

For the output pair, part of the bias resistance is common to both tubes, and part is a balance potentiometer for the stage. The power supply uses a 6X4 to provide 300 volts. Current consumption is 75 ma and goes up to 90 ma at the full power of 14 watts. This may seem to exceed the rectifier rating. However, in actual use peak power is reached only for short times.

Two filters are used, one with a choke for the output stage and driver, and an extra one with a resistor for the input triode and the screens of the output pair.

Fifteen db of feedback is used. At 10 watts, total distortion is 2%. The nominal output power is 10 watts, the maximum output power 14.

Printed-circuit amplifier

A 10-watt hi-fi printed-circuit amplifier, produced in France by Coprim, is shown in Fig. 3. The printed-circuit board contains the four tubes and their associated components. The complete amplifier is obtained by adding an output transformer, power supply, and tone control.

The input tube is an EF86/6267 used as a voltage amplifier. It is followed by a 12AX7 second af amplifier and phase inverter in a cathode-coupled circuit. This allows direct coupling between the EF86 plate and the 12AX7's input grid, eliminating low-frequency attenuation and phase shift due to the usual coupling capacitor. Notice the slightly different load resistors in the 12AX7 plate circuits to compensate for the reduced gain of the bottom triode. The output stage uses a pair of EL84's working class AB. Suppressor resistors are used in both control and screen grid circuits.

Feedback taken across the output transformer's secondary is applied to the input cathode through a connecting network. Two other compensation networks are provided, one between the plate of the input tube and B-plus, and another one between plate and grid of the grounded-grid phase inverter.

The power supply is conventional and

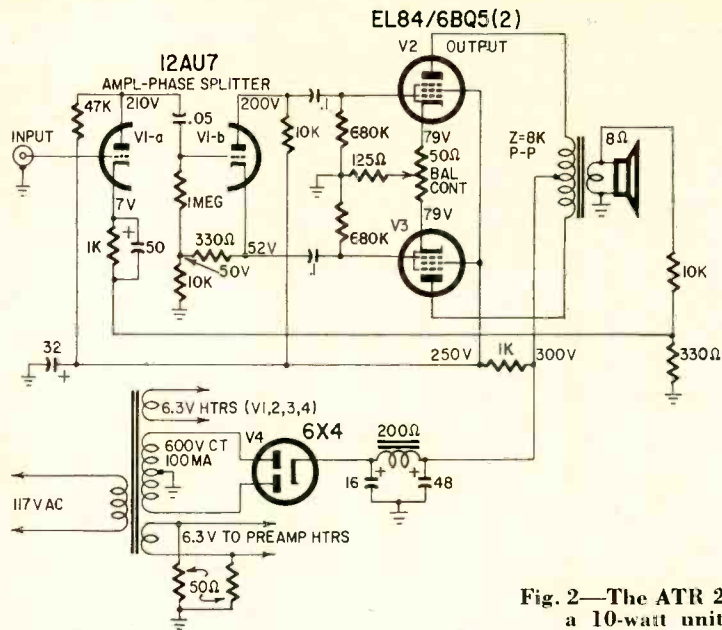

Fig. 2—The ATR 212 is a 10-watt unit.

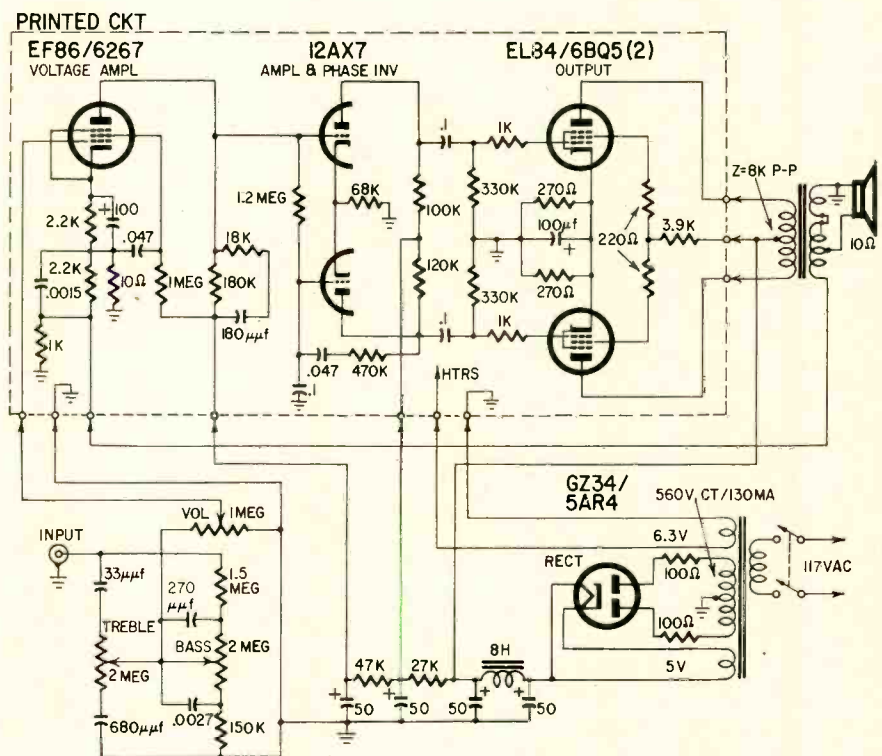
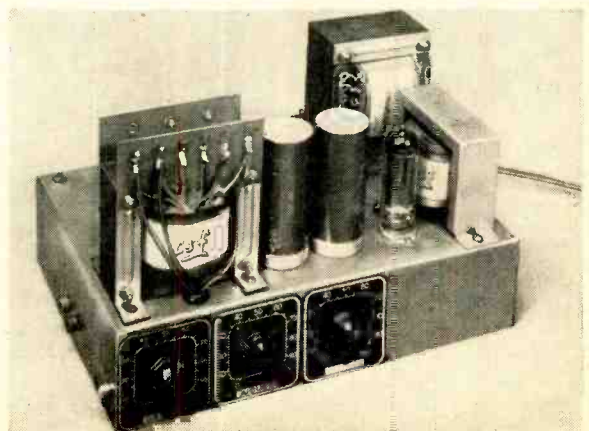

Fig. 3—Circuit of the Coprim printed-circuit amplifier.



Top view of the printed-circuit Coprim amplifier.

triodes of the 12AX7 contains the separate bass and treble controls of the Baxandall circuit. It assures approximately 20 db of boost or cut at 20 and 20,000 cycles. Some feedback is provided by the unbypassed cathode resistors in both triodes.

Often, the distance between the preamp and amplifier is great. The interconnecting shielded wire then has a large capacitance and this, of course, is detrimental to the high frequencies. To obviate this, an EF86 cathode follower provides a low-impedance output.

Besides the shielded wire carrying the signal, the preamp is connected to the amplifier by a multiconductor cable terminated in a standard octal plug. This cable carries the 6.3-volt heater and the stabilized 150-volt B-plus lines provided by the amplifier. It also carries line voltage to the on-off switch, thus permitting the amplifier to be controlled remotely from the preamp's front panel.

Preamp characteristics are:

Phono input: 6 mv for 1-volt output; response flat within 2 db from 1,000-10,000 cycles; signal-to-noise ratio 58 db for 1-volt output and flat tone position.

Low-level input: 4 mv for 1-volt output; response flat within 2 db from 30-6,000 cycles; signal-to-noise ratio 60 db for 1-volt output.

Normal-level input: 250 mv for 1-volt output; response flat within 2 db from 10-60,000 cycles; signal-to-noise ratio 55 db for 1-volt output.

Tone control: +19 to -18 db at 20 cycles; +16 to -18 db at 20,000 cycles.

Matching low-power amplifier

The 10-watt amplifier following the preamp uses four tubes, a rectifier and a voltage regulator. Its circuit is shown in Fig. 5. The input voltage amplifier

A look at the internal works of the RSL 12-25.

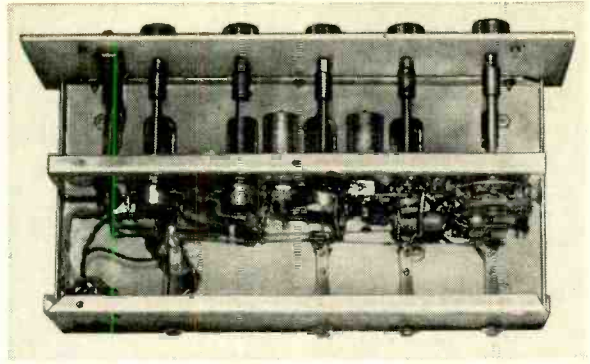

is a low-noise EF86, triode-connected, which drives directly a cathode-coupled phase inverter 12AX7. This is followed by the output pair of EL84's working class AB. The output stage balance is adjusted by the cathode potentiometer. The output circuit is Ultra-Linear. The output transformer secondary has multiple windings, and the usual impedances are readily obtained through a switching arrangement. Feedback (20 db) is taken across the 15-ohm winding and applied to the input cathode. Suppressor resistors are used in the control and screen grids of the output stage.

The power supply uses a standard transformer and a medium-power rectifier. Filtering is thorough, additional filters being used for the first two tubes. A neon voltage regulator provides

stabilized B-plus, at 150 volts for the preamp.

The heater winding is grounded through a 50-ohm potentiometer, adjusted for minimum hum. Actually, the arm of the pot is not connected to ground, but to 25 volts positive. This simple arrangement further minimizes hum. The important voltages are indicated on the diagram.

Performance figures are:

Maximum output power 12 watts.

Nominal output power 10 watts.

Frequency response flat from 20 to 50,000 cycles, and 3 db drop at 10 and 170,000 cycles.

Sensitivity 0.6-volt input for 10 watts output.

Distortion 0.25% at 10 watts and 1% at 12 watts.

Under the chassis of the Symphonie.

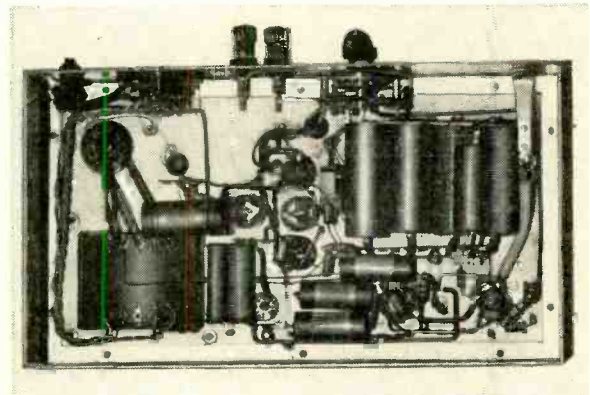
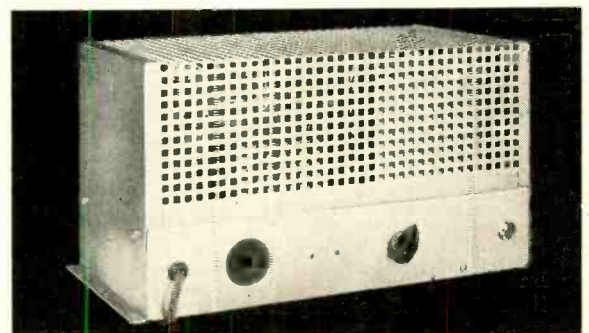
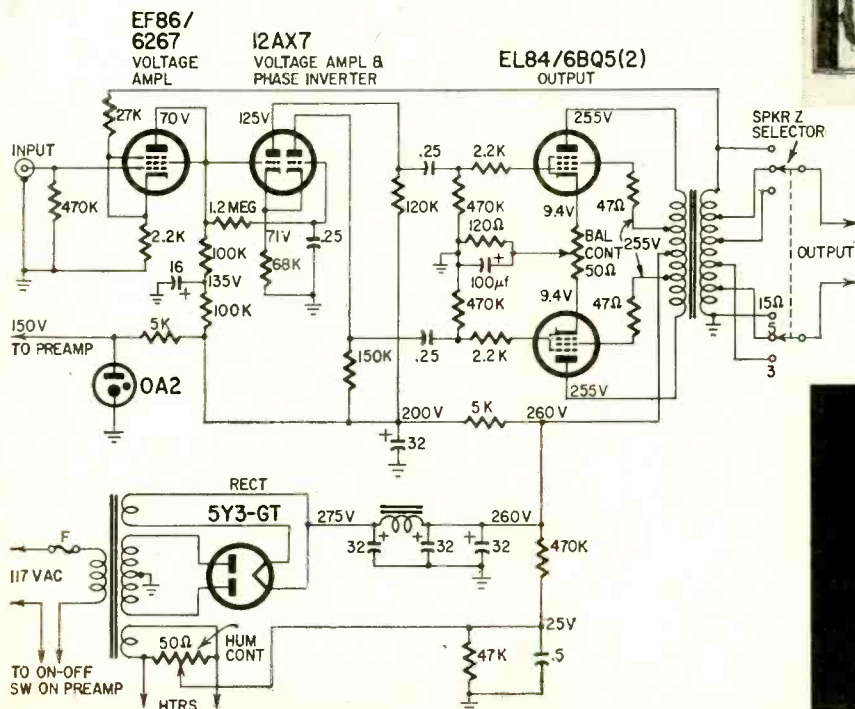

Fig. 5—The 10-watt Radio-Saint Lazare Symphonie (front view shown below) has the added luxury of a voltage-regulator tube.



AUDIO—HIGH FIDELITY

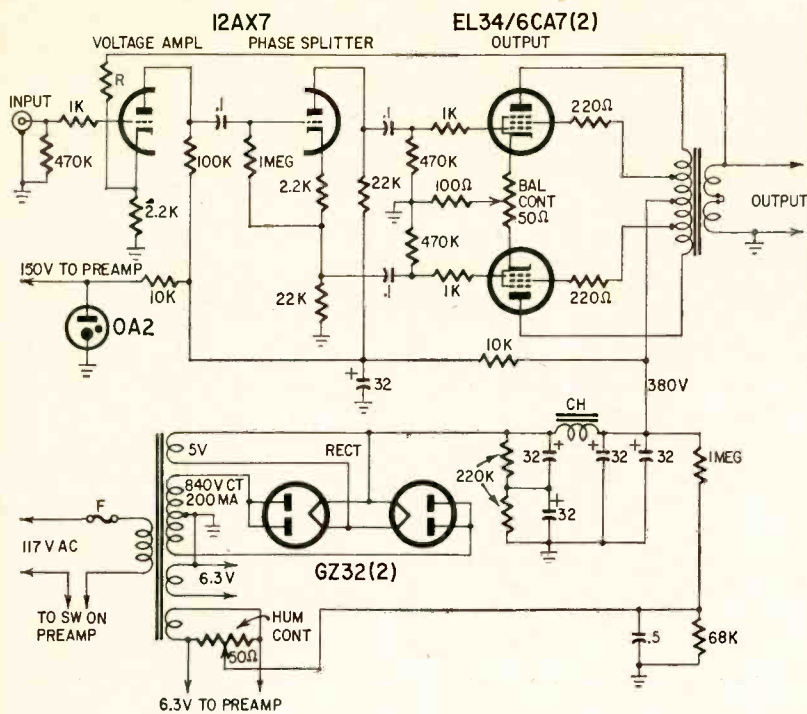

Fig. 6—The 25-watt Panasonic uses popular EL34's in its output stage.

Noise 80 db at nominal output.

25-watt basic amplifier

This 25-watt amplifier can also be connected to the Radio-Saint Lazare preamp. It uses three tubes, two rectifiers and a voltage regulator (see Fig. 6). The first triode of a 12AX7 is a voltage amplifier. It is followed by the second triode of the same tube, in a split-load circuit. This drives the output pair of EL34's, balanced with the help of the cathode pot. The output circuit is an Ultra-Linear type. The output transformer has two secondaries. They can be parallel- or series-connected and provide 3.5- and 15-ohm impedances.

Feedback is taken across output transformer's secondary and applied to the input cathode through resistor R. This resistor is 22,000 ohms for a 15-ohm output and 10,000 ohms for a 3.5-ohm output. Suppressors are used in the control and screen-grid circuits of the output pair and in the input grid.

The power supply uses a sturdy transformer and two medium-power rectifiers. This arrangement is preferred to a single high-power rectifier. Good filtering is provided. Since the B-plus reaches 400 volts, the input capacitance for the filter is made up of two capacitors in series for safety. A voltage-regulator tube provides a stabilized 150 volts for the preamp.

Performance figures are:

Maximum output power 30 watts.

Nominal output power 25 watts.

Frequency response flat from 20 to 50,000 cycles, down 3 db at 15 and 120,000 cycles, down 6 db at 10 and 140,000 cycles.

Feedback 10 db.

Sensitivity 0.8-volt input for 25-watt output.

Distortion 0.5% at 25 watts.

Noise -90 db at nominal output.

The design is very conservative

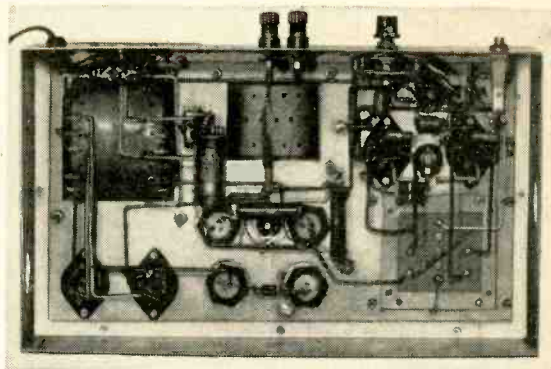

Panasonic amplifier has a neat wiring layout.

throughout. For example, the voltage at the EL34's anodes is only 380.

The photograph shows the wiring under the chassis. Its appearance is similar to that of the 10-watt amplifier, except that it is larger and much heavier, because of the large power transformer and filter choke.

The European tubes used in all the diagrams are readily available in this country; for example, they are marketed by Amperex. Similarly, a number of excellent output transformers for EL84's and EL34's, both standard and Ultra-Linear types, are available from many manufacturers. END

YOU'RE SAFE!



You're safe when you buy tubes by mail from advertisers in RADIO-ELECTRONICS. These advertisers meet RADIO-ELECTRONICS requirements for mail order tube advertising by telling you specifically in the ads that the tubes they are selling are new and unused. If the tubes are seconds, rejects, or otherwise not perfect, they tell you that too. When you buy their tubes—you know what you're getting—and you get what you pay for.

STEREO

PHONO

CARTRIDGES

By JULIAN D. HIRSCH

WHEN the Westrex stereo disc system was announced last fall, there were no commercial cartridges designed for stereo disc reproduction available, nor were there any commercial records available. The initial demonstrations of the Westrex system were made with special records cut by Westrex, using special reproducers of their design and manufacture.

Shortly afterward, Fairchild announced its model 603 stereo pickup, but the \$250 price tag made it unsuitable for the average hi-fi enthusiast. Not long after the announcement of the Westrex development, Audio Fidelity began to issue stereo discs, and at this time they are available from several manufacturers. Large stereo catalogs are expected in the near future.

Since the general acceptance of the Westrex (or so-called 45/45) stereo system, there has been a flurry of activity on the part of pickup manufacturers to develop suitable cartridges which could be sold at a reasonably low price. At the time of writing, at least 15 makes of stereo cartridges are advertised for sale, with delivery either immediately or within the next several months.

It appears that anyone planning to build or buy a stereo system—or to convert his present system to stereo—will face a confusing choice from among a large group of cartridges. This situation closely parallels the present one with conventional (monophonic) cartridges, except that the stereo field is so new that few people have any experience to aid them in making a selection.

In this and the following article, a number of the stereo cartridges currently available will be described and their performance specifications presented to the extent that they have been made public. This information has been obtained directly from the manufacturers, and no attempt has been made to compare the cartridges' performance.

The reader who is not familiar with the Westrex stereo disc system (and the reader who is, for that matter) is referred to the excellent article by Norman Crowhurst ("How the Stereo Disc Works") in *RADIO-ELECTRONICS*, July, 1958. Most of the cartridges described in these articles are basically similar to those illustrated in that article.

Stereo cartridges, like the monophonic

Part I—Ceramic and crystal types including the Astatic Soundflo, Columbia SC-1, E-V series 20 and series 60, Erie Stereo, Ronette BF-40, Sonotone 8T, and Webster Electric SC-1D

The Astatic Soundflo stereo cartridge.

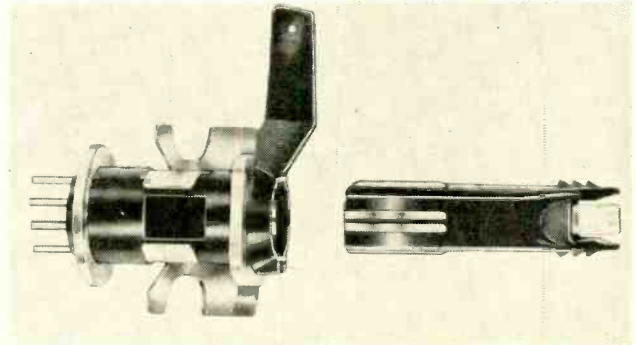

types we are familiar with, fall into the categories of *amplitude-responding* and *velocity-responding* types.¹ So far there are approximately equal numbers of both types available. The ceramic and crystal cartridges, which fall into the first category, are generally priced well below the magnetic cartridges. In most cases, they are aimed at a low-cost mass market. Some of them, however, are good enough to appeal to the audio hobbyist. Their level and frequency response characteristics are similar to those of monophonic ceramic cartridges, and they will be played through the "crystal or ceramic" amplifier inputs.

In this article the ceramic and crystal types of stereo cartridges will be described. The listing is in alphabetical order by the manufacturer's name.

Astatic Soundflo

The Astatic Soundflo stereo cartridge is a low-priced unit aimed at the mass consumer market. It is a plug-in type, so the entire active element of the cartridge is replaced with the stylus. The turnover type element plugs into a holder which mounts in any standard arm with 7/16- or 1/2-inch mounting centers. A lever on the holder rotates the cartridge to place the desired stylus in playing position.

The rated frequency response is 20–15,000 cycles. The nominal output is 0.5 volt. A choice of stylus combinations is available—0.7-mil and 3-mil sapphires, a 0.7-mil diamond and 3-mil sapphire or a pair of 0.7-mil sapphires. The latter combination effectively doubles the useful life of the cartridge where only

microgroove records will be played, without requiring an investment in a diamond.

Compliance in both vertical and lateral planes is 2×10^{-6} cm/dyne. The rated tracking force is 5–7 grams. Channel separation (crosstalk) is 25 db.

A unique feature of the Astatic cartridge is the complete separation between the two ceramic elements. Most stereo cartridges use a common ground for the two channels. The Astatic Soundflo has *four* output terminals instead of the usual three. Therefore, the two channels may be completely isolated electrically. This can be advantageous when using ac-dc amplifiers, since there is less likelihood of ground loops and resulting hum problems. Also, the two channels can be phased at the cartridge rather than at the speaker.

The net price of the Astatic cartridge is approximately \$4.10 with sapphires and \$12 with a diamond-sapphire combination. The cartridge only, less the mount, is about 60¢ less. At the time of writing, only tentative prices were available, and actual prices may be considerably different from those quoted here.

Columbia model SC-1

The Columbia SC-1 is a dual-element ceramic type with a single replaceable stylus. The stylus assembly is mounted with a single small screw. The cartridge mounts on standard 7/16- or 1/2-inch centers.

The weight of the Columbia SC-1 is 5.5 grams. Its frequency response (relative to the RIAA characteristic) is 30–16,000 cycles within 2.5 db. The nominal output voltage is 0.4 volt. It is

¹ "Modern Phono Cartridges," Parts I-IV, J. D. Hirsch, *RADIO-ELECTRONICS*, April-July, 1957.

AUDIO—HIGH FIDELITY

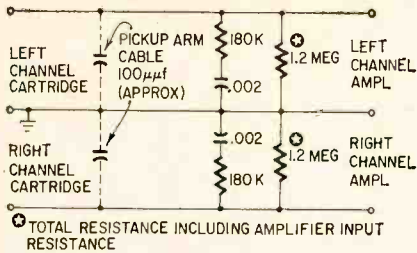
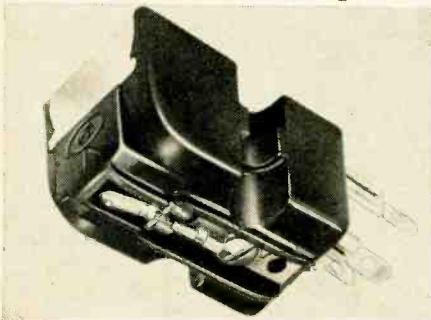

Fig. 1—Equalizing network for the Columbia SC-1 stereo cartridge.

supplied only with a 0.8-mil diamond stylus. The lateral and vertical compliance is 2×10^{-6} cm/dyne. Recommended tracking force is 5-7 grams. Minimum channel separation is 20 db.

The stylus is coupled to the ceramic elements through a positive mechanical linkage providing a 4-to-1 lever action. The manufacturer recommends this cartridge for playing 78-rpm as well as microgroove records. The low mechanical impedance allows the 0.8-mil stylus to follow the bottom of the large record



The Columbia model SC-1.

groove without skidding and with low needle talk.

For correct equalization of the RIAA recording characteristic, the Columbia SC-1 should be terminated in the network shown in Fig. 1.

Electro-Voice series 20

The first ceramic stereo cartridge to appear on the market was the E-V model 21. The basic structure of this cartridge was clearly described by Crowhurst in the article referred to earlier.

The model 21 is a single-stylus unit, available with either diamond or sapphire stylus. A dual-stylus turnover cartridge, the model 26 ST, is also available. It is effectively two cartridges, with the entire cartridge body rotating in its mount to place either the microgroove or 3-mil stylus on the record.

The stylus is mounted at the end of a light, hollow metal tube which is supported at its other end by a thin wire extending along the axis of the tube. Since the stylus support has a symmetrical cross-section, its compliance is the same in both vertical and lateral planes. The entire stylus assembly clips onto the plastic body of the cartridge near the terminals at the rear. The hollow stylus tube rests in a compliant wedge-shaped block which also is in contact with the two ceramic elements. The 45/45 mounting of the elements can be clearly seen in the photograph of the

cartridge without its plastic case.

The E-V model 21 cartridge weighs only 2-4 grams, and the model 26 weighs 2.6 grams. The frequency response, referred to the RIAA characteristic, is within 2.5 db from 20 to 16,000 cycles when the cartridge is terminated in a 3-megohm load resistance. Bass response may be extended further, down to 10 or 15 cycles, by increasing the load resistance to 5 to 9 megohms. The nominal output voltage is 0.5.

The model 21 is available with a 0.7-mil stylus, either sapphire or diamond. The model 26 is available with a 0.7-mil and a 3-mil sapphire or a 0.7-mil dia-

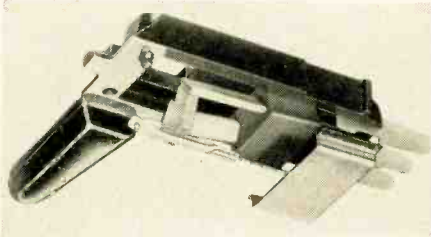

Cutaway view of the Electro-Voice turnover stereo job.

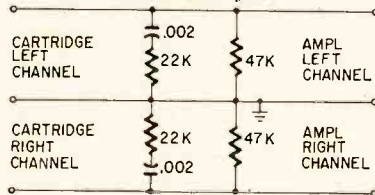

Fig. 2—Network for magnetic equalization of E-V series 21 or 26 stereo cartridge.

mond and a 3-mil sapphire. The vertical and lateral compliance of both types is 2×10^{-6} cm/dyne, and the recommended tracking force is 6 grams. The channel separation of the E-V cartridges is 20 db or better over most of the useful frequency range.

The E-V stereo cartridges feature a vertical rumble eliminator, which reduces the low-frequency response in the vertical plane. This appears to be done by a vertical compliance in the mounting of the ceramic elements. Since the full frequency range is covered by the lateral output, which is common to both channels, there is no loss of fidelity, and it is stated that no stereo effect is sacrificed since very low frequencies do not contribute to directional effects.

The net price of the model 21 cartridge is \$9.90 with a sapphire stylus and \$19.50 with a diamond stylus. The turnover model 26 is priced at \$12.50 with two sapphires and \$22.50 with a diamond-sapphire combination.

If it is desired to use the magnetic (equalized) inputs of the preamplifiers, it is possible to terminate the two cartridge outputs in the simple R-C network shown in Fig. 2. This reduces the output voltage to levels comparable to that of magnetic cartridges, and gives a response characteristic similar to that of a magnetic cartridge. Electro-Voice manufactures a magnetic adapter which incorporates the necessary equalization for both channels, as well as a selector

switch for reversing channels or for monaural operation.

In the near future, the 21M and 26M cartridges will be available. These are similar to the standard 20 series units except that they are intended to plug directly into magnetic preamplifiers without the external equalization network we have described.

"Power-Point" cartridges

The E-V Power-Point cartridges are low-cost units for use in inexpensive home phonographs. They are now available in a stereo model, the model 61, with two 0.7-mil styli and the model 66 with a 0.7-mil and a 3-mil stylus.

These cartridges are designed to plug into a holder which mounts on standard 1/2- or 7/16-inch centers. The entire element is replaced when the stylus becomes worn. Two types of holder are available, one for fixed and the other for turnover cartridges.

In general, the specifications for the series 60 cartridges are similar to those

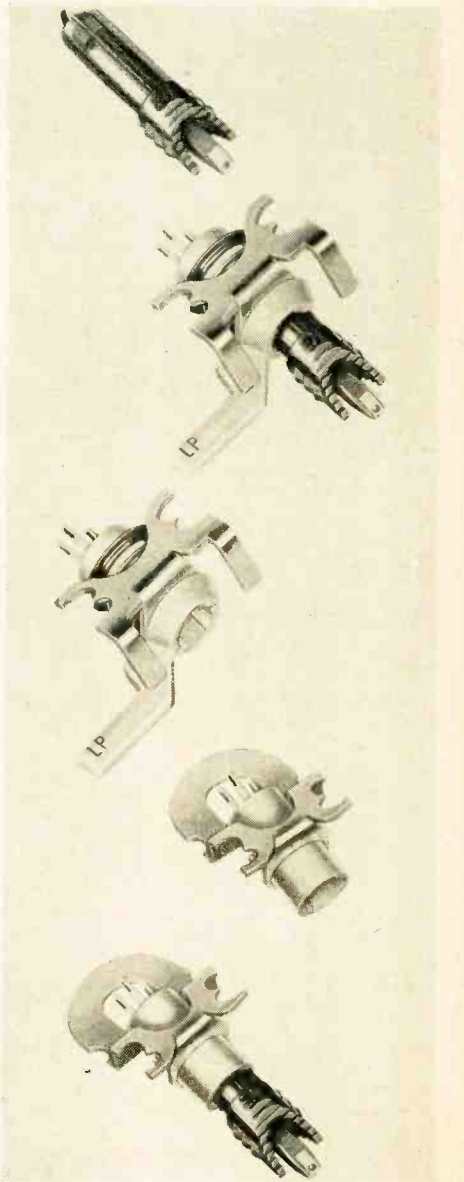

Electro-Voice stereo Power-Points and mounts.

of the series 20, except that the high-frequency response is not as extended and channel separation is only 15 db.

The series 60 cartridges are priced at \$3.50 with two sapphires and \$11.50 with a diamond-sapphire stylus combination. The turnover and fixed holders cost 60¢ and 30¢ respectively.

Erie "Stereo" cartridge

The Erie Stereo cartridge is a plug-in design in which the entire element is

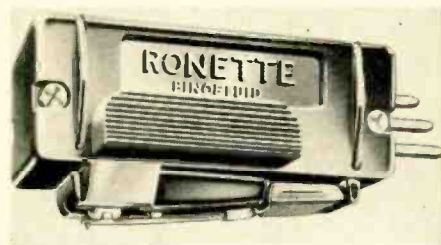

The Ronette Binofluid BF-40.

replaced together with the worn stylus. The mounting fits pickup arms with standard centers.

It features a single ceramic element, unlike the other units just described, which have two elements. No details have been released on how the element is driven on two mutually perpendicular axes to obtain separate outputs.

The cartridge weighs 3 grams. Its response above 1,000 cycles is flat within 3 db through the audio range. When terminated in the recommended 2-megohm load resistor, the response of the Stereo cartridge falls off gradually below 1,000 cycles, and is down 7 db at 100 cycles. A small amount of bass boost from the amplifier's tone controls compensates for this drop. The nominal output voltage is 0.4.

A choice of two LP styli or an LP-78-rpm combination stylus is available, either in sapphire or diamond-sapphire. The cartridge turns over in its mount to place the correct stylus on the record. The compliance is greater than 1.7×10^{-6} cm/dyne, and the recommended tracking force is 5-6 grams.

The channel separation is at least 20 db from 30 to 8,000 cycles. Above 8,000 cycles, the crosstalk increases gradually to about 12-db separation at 15,000 cycles.

Ronette BF-40

The Ronette BF-40 Binofluid stereo cartridge employs two humidity-proofed crystal elements, driven through a direct mechanical coupling, by a single stylus (see Fig. 3).

When terminated in the recommended 500,000-ohm load resistance, it is self-equalizing for the RIAA characteristic within 3 db from 30-15,000 cycles. The output is approximately 0.35 volt per channel.

The stylus assembly is of the snap-in replaceable type. It is available with a 0.75-mil stylus, either sapphire or diamond. The compliance in both vertical and lateral planes is relatively high, 3.5×10^{-6} cm/dyne. A tracking force of 5.5-6 grams is recommended in record

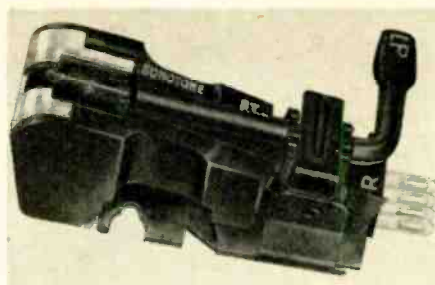

Sonotone's 8T stereo turnover unit.

changers. Less force would be needed in a better quality arm. Ronette claims a very high channel separation, 26-28 db at 1,000 cycles and 20-22 db at 10,000 cycles.

The net price of the Ronette BF-40 with sapphire stylus is \$12. With a diamond stylus it is \$18.60. It is also available integrally mounted in a Ronette arm at an additional cost of about \$4 for the 12-inch arm and \$5.60 for the 16-inch arm.

Sonotone model 8T

The Sonotone 8T is the stereo counterpart of the well known 3T monophonic cartridge. It contains two ceramic elements, driven by a single stylus. The stylus assembly is of the simply replaced clip-in turnover type used in the older 3T series.

The weight of the Sonotone 8T is 7.5 grams. It mounts in any arm that has standard 7/16- or 1/2-inch mounting centers.

Frequency response of the 8T is smooth (within 2.5 db) from 20-12,000 cycles, with a gradual rolloff above 12,000 cycles. The nominal output voltage is 0.3.

The turnover stylus has 0.7-mil and 3-mil jewels. These are available as two sapphires, a 0.7-mil diamond with a 3-mil sapphire, or two diamonds. The compliance is 2×10^{-6} cm/dyne. Rated tracking force is 5-7 grams. The recommended load resistance is 1 to 5 megohms. Low-frequency response is better with the higher values. Channel separation is 20 db at 1,000 cycles and somewhat less at lower and higher frequencies.

The Sonotone 8T features a special mounting bracket which reduces vertical rumble. The cartridge mounting bracket has a cantilever extension which is the only part of the cartridge to actually contact the arm. This extension of the mounting bracket is cut away so as to have a relatively high vertical compliance, and acts as an acoustic trap or filter which reduces the low-frequency response in the vertical channel. It has no effect on the frequency response of the lateral channel.

The net price of the Sonotone 8T is \$8.70 with sapphire styli, \$14.70 with a diamond and a sapphire, and \$20.70 with two diamonds.

Webster-Electric SC-1D

The Webster-Electric SC-1D is a single-stylus plug-in cartridge. It fits a mounting clip which may be installed

in any standard arm. The entire cartridge element may be plugged in or out without tools, and the stylus may be replaced independently of the cartridge element.

Its frequency response is 30-15,000 cycles, and the output voltage 0.5. The stereo stylus is a 0.7-mil diamond. A special cartridge insert, with a single ceramic element and a 3-mil sapphire stylus, is also available for playing 78-

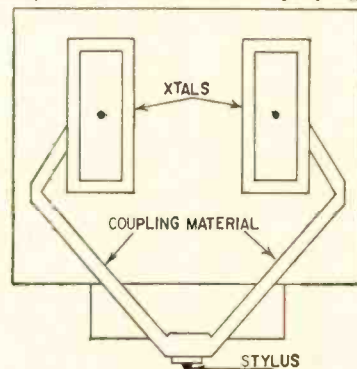

Fig. 3 — Mechanical coupling arrangement of Binofluid BF-40.

rpm records. The recommended tracking force is 5-7 grams.

The net price of the Webster-Electric model SC-1D is \$14.70 with 0.7-mil diamond. The 78-rpm insert with 3-mil sapphire stylus is priced at \$4.50.

Summary

This listing of ceramic stereo cartridges is necessarily incomplete because new ones are continually appearing. In addition, specific details as to the internal construction are not available for many of the newer types. Prices were those in effect on July 1.

It is already apparent that there is as much diversity in design and appearance among the stereo cartridges as among the older monophonic types. It is interesting to see that the general price level of the stereo types is no higher than that of monophonic cartridges. The cost of the diamonds appears to have come down appreciably (especially when the 0.7-mil tip radius is considered), so in many cases the stereo cartridges are cheaper than the single-channel counterpart with a diamond stylus.

The increased vertical and lateral compliance of the stereo cartridges, necessary for avoiding damage to the stereo grooves, may make them superior to the older cartridges for reproducing standard LP records. The smaller stylus radius should also provide better tracking, particularly of heavily modulated inner grooves.

It would seem reasonable for anyone considering the purchase of a ceramic or crystal phono cartridge to buy a stereo type, even if he has no immediate plans for a stereo disc system. This would be the case even if they were more expensive than the monophonic types, instead of less expensive.

In next month's article, a number of magnetic stereo cartridges will be described.

TO BE CONTINUED

improving RADIO and PHONO AMPLIFIERS

If it's a push-pull job, the simple changes mentioned here will make a startling improvement in the way the unit sounds

By NORMAN H. CROWHURST

AM often asked whether anything can be done to improve a relatively inexpensive radio, phono or combination hi fi, by adding feedback to the amplifier "or something." The answer is, "It depends."

If you bought an inexpensive hi-fi radio-phono combination or just the phono complete in a single cabinet, the speakers are probably inadequate. To improve quality appreciably, you will need better speakers mounted in a separate enclosure. It's no good having a first class amplifier and then feeding it into one or more small speakers housed in the same cabinet with the phono combination.

The circuit used determines how much the amplifier can be improved. Most radio-phono circuits that feed a single speaker have a single-ended output stage, usually using a 6AQ5 or 6V6-GT. There isn't too much that can be done to improve this setup. The single-ended output transformer usually has a rather high-resistance primary, which makes it relatively inefficient and blocks successful feedback action even supposing you can find some way of supplying it. The kind of amplifier that can be improved is that using push-pull output tubes, usually to feed two or more small speakers.

Adding feedback

Most push-pull 6AQ5 or 6V6-GT circuits use a driver circuit of the type shown in either Fig. 1 or Fig. 2. Both arrangements use a twin triode, but one is a split load (Fig. 1) while the other is a paraphase phase inverter (Fig. 2). Immediately preceding this tube, you will usually find the volume control or the tone control. It is not feasible to apply feedback over more than the output tube and this twin triode.

The method of applying feedback depends on the driver circuit and the type of twin triode already in the circuit.

Let's take the split-load inverter first. Before we can apply negative feedback, we need more gain in this stage. Otherwise, the feedback will reduce the gain and the amplifier will not give enough output from the available input. If the

twin triode is a 12AU7 or a 12AT7, additional gain can be picked up by using a 12AX7 instead.

Circuit values, resistors in particular, will need changing to make the most of the tube change, because the coupling resistors found with a 12AU7 or 12AT7 will be too low to give the full gain of which the 12AX7 is capable. To improve stability, the tubes can also be rearranged for direct coupling in place of the R-C coupling used in most of these circuits.

If the circuit is already direct-coupled, no change, other than modifying the resistor values, is necessary. Simply fit in the values shown in Fig. 3. This will produce satisfactory operating conditions for the 12AX7 as a direct-coupled amplifier-phase inverter.

Now we apply the feedback. This is done by connecting one end of the output transformer's secondary to ground and the other end through a feedback resistor to the 1,000-ohm amplifier stage bias resistor. For a start, try 100,000 ohms for the feedback resistor.

The amplifier may oscillate furiously. This indicates that the phasing is wrong. The simplest method of remedying this is either to ground the opposite end of the transformer secondary and connect the resistor to the end that was grounded, or reverse the primary connections to the output tube plates.

Having made the change in phase,

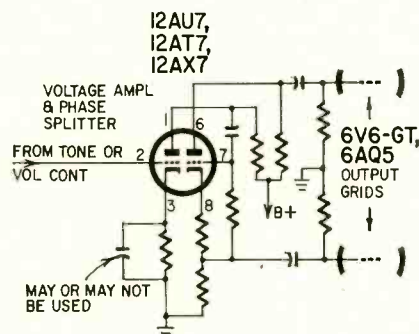

Fig. 1—One basic circuit, used to drive push-pull 6V6-GT or 6AQ5 output tubes, can be improved using the method outlined in this article.

where necessary, the amplifier should be stable, and the gain less than when the 12AX7 was first inserted and values changed. Now adjust the value of the feedback resistor until there is a comfortable margin of gain for operating on radio, phono or both, but not more than you need.

The lower the resistor value, the more the negative feedback and the better the cleanup action. But if you use too much feedback (too low a resistance value), you will not get enough output and may run into instability. If you find the amplifier becomes unstable at either low or high frequencies, increase the value of the feedback resistor until the amplifier becomes stable (a scope or audio vtvm will tell you when the amplifier is stabilized). But the amount of extra feedback you can use, while maintaining the original gain of the amplifier, usually will not cause any instability.

Next we will consider the set in which the amplifier and phase splitter is already a 12AX7. Here we can't increase gain by simply changing the tube and resistor values. We already have the twin triode that gives the most possible gain. So this time we use positive feedback to get the extra gain.

The circuit values and wiring changes necessary are shown in Fig. 4. For this purpose, the bottom end of the phase-splitter cathode resistor is returned to the cathode of the amplifier

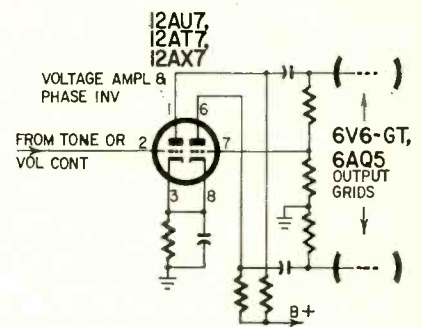

Fig. 2—A little doctoring with increased gain and feedback will improve this common driver circuit.

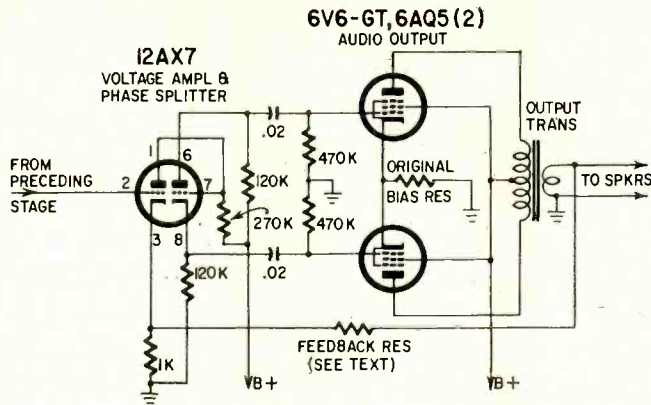

Fig. 3—If the tube in Fig. 1 was a 12AU7 or 12AT7, the circuit can be improved by changing to a 12AX7 with the values shown here and adding feedback.

Fig. 4—If the circuit of Fig. 1 already used a 12AX7, use positive feedback to get the extra gain needed for negative feedback. Suitable values are shown.

stage and this provides positive feedback, almost enough to cause oscillation. It will increase gain four or five times.

Now we apply feedback from the secondary of the output transformer, as in Fig. 3, starting with a 68,000-ohm resistor. If the connection first used causes oscillation, reverse one of the transformer windings to stabilize the amplifier and then adjust the feedback resistor until you finish up with about the same gain the amplifier originally had.

Now for the paraphase type circuit (Fig. 2). If the tube is a 12AU7 or a 12AT7, we can get the necessary extra gain by changing to a 12AX7. This definitely involves changes in resistor values. For one thing, the resistors that provide the grid swing for the second tube of the phase inverter will give the wrong voltage—much too high for a 12AX7. So the values shown in Fig. 5 should be used for a 12AX7 paraphase inverter to feed 6AQ5 or 6V6-GT push-pull output.

If the original circuit had a common bias resistor and decoupling capacitor for both halves of the driver, replace them with separate biasing resistors, as in Fig. 5. In this circuit the first cathode cannot be bypassed to ground because it is used for feedback injection. The second cathode should not be bypassed either, to maintain symmetry and to help stabilize the gain of the phase inverter.

Finally, you apply feedback from the secondary of the output transformer to the first cathode, reversing a winding if necessary, and adjusting the resistor to get the right gain. Start with 220,000 ohms for the feedback resistor.

If this circuit originally came with a 12AX7, the only thing you can do is use positive feedback and the only way to do this is to revert to the circuit of Fig. 4. This changes the phase inverter from a paraphase to a split-load type. The values and procedure for adjusting the feedback will be exactly the same as for Fig. 4.

Boosting overload performance

One more step is needed to improve

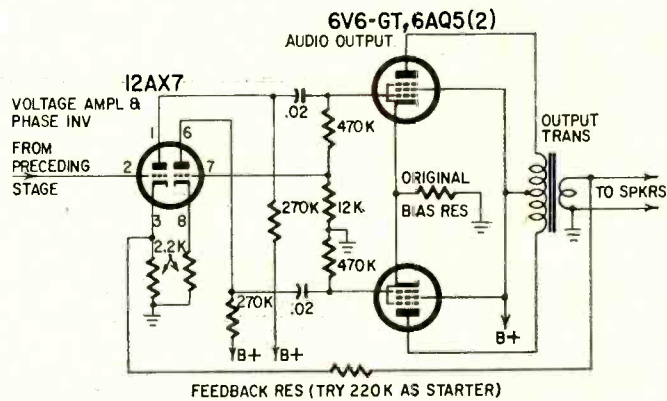
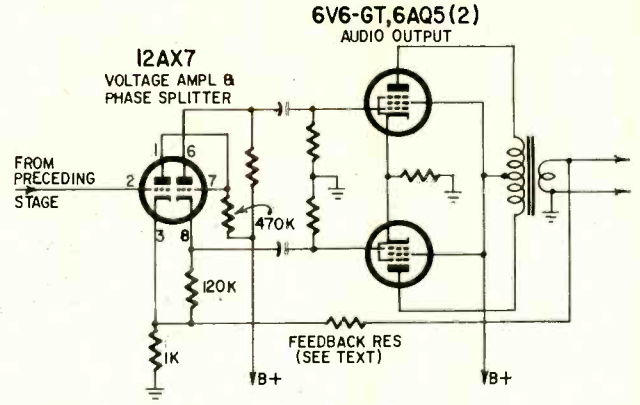

Fig. 5—Values associated with a 12AX7 paraphase circuit when this can be used to pep up the circuit of Fig. 2.

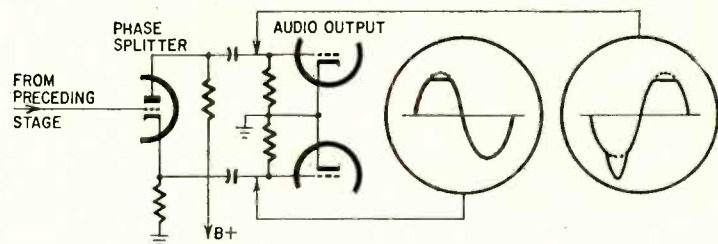

Fig. 6—A particular kind of waveform distortion occurs at overload with a split-load phase inverter.

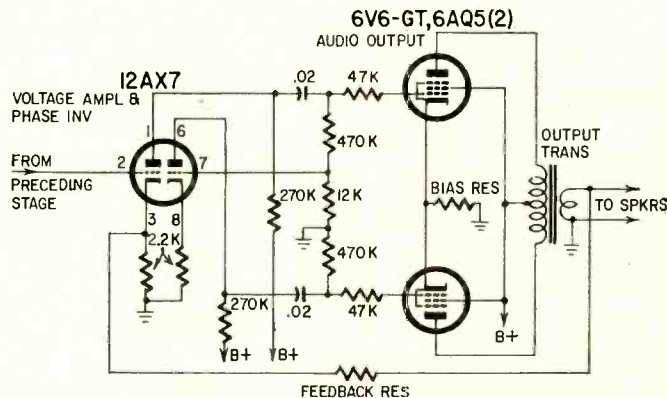

Fig. 7—The paraphase inverter circuit after all modifications have been made.

either of these circuits. When feedback is applied to these amplifiers, it cleans up low-level distortion very well. But adding feedback also means that the amplifier overloads much more suddenly. This causes grid current in the output tubes and sets up serious clipping and crossover distortion immediately after overload occurs.

In the split-load phase inverter the overload effect also causes asymmetry due to bypassing the cathode section of the load and producing a sudden increased amplification in the plate half of the load for this section of the waveform (see Fig. 6).

The remedy for both defects, in either the split load or the paraphase, is to insert a resistor in series with each output tube grid. A 47,000-ohm unit proves satisfactory for this purpose when working with a 12AX7 phase inverter. Fig. 7 shows the series grid resistors added to the paraphase circuit. They can also be used in the same position with the split-load phase inverter or, for that matter, in any similar output stage.

When overall feedback is connected in the correct phase to be negative and to end up with about the same gain the amplifier had originally, these changes should not cause instability or parasitic oscillation.

If any trouble is experienced (checked by looking at the output with a scope if it does not sound "clean at all times), the cause is probably inadequate decoupling in the B-plus supply to the 12AX7. This should be remedied by inserting decoupling, consisting of a 22,000-ohm resistor and a 40- μ f 350-volt electrolytic, in the feed to the 12AX7 plates. But this will seldom, if ever, be necessary.

All these changes, when applied to many radio and phono amplifiers will improve their performance considerably. Notably they cut distortion, both harmonic and intermodulation. Harmonic distortion is not very noticeable, but intermodulation is responsible for the rather "muddy" quality these amplifiers give. It has the effect of mixing up all the instruments in the orchestra, so, instead of hearing distinct separate instruments, they all seem to be muddled together. Changing the circuit cleans up the distortion and makes reproduction much crisper and clearer.

Additionally, it improves the amplifier's overload characteristics somewhat, so the distortion is not so noticeable if the volume is turned up too far. Particularly important to this aspect of the improvement are the 47,000-ohm resistors in series with the output-tube grids.

These changes should improve a low cost "hi-fi" set that proved to be not as hi-fi as anticipated, so that the quality of the presentation is much better. Once you have changed the amplifier and added some better speakers, there may be other changes you can make, like getting a better pickup. More about these some other time. **END**

Covering the full audio range the HFS-2 speaker system is especially suited for stereo hi-fi systems

SPEAKER SYSTEM for the STEREO AGE

**By A. STEWART HEGEMAN and
NORMAN EISENBERG**

STEREO'S coming of age has caused designers to focus new attention on the special factors applying to that type of reproduction. Chief among these factors, which are largely responsible for the "spread" and naturalness of stereo (but which, interestingly, have been given little attention in the past) are omnidirectionality—not merely "fanning out" of the sound but true circular distribution—and linearity of phase shift (constant time delay) in the acoustic transmission system represented by the speaker. Thus the speaker system on our cover this month, the Eico HFS-2, designed by A. Stewart Hegeman, takes into account not only the traditional demands of speaker systems, but also the special requirements of the new art of stereo.

Linear phase shift maintains the temporal spacing of the elements of any transmission—for example, the relationship of overtones in reproduced music. Disturbance of this relationship, while not easy to measure, does constitute a serious intermodulation effect.

To meet the requirements of linear phase shift, the ideal reproducer would be a zero-point source that would radiate a perfect wavefront over the full audio spectrum. Such a reproducer would also be inherently omnidirectional, something like a sphere of infinitely small size expanding and contracting. The same design techniques that make for linear phase shift do, at the same time, make for omnidirectionality.

Omnidirectionality is a problem largely restricted to mid-range and high frequencies. These tones tend to beam, resulting in unpleasantness and lack of naturalness in reproduction, caused by the loss of the spatial characteristics typical of live sound.

Omnidirectionality is important, too, for its ability to re-establish in a small room something of the natural ratio of reflected to direct sound (often as high as 4 to 1) that we hear in the

concert hall. Obviously, any reproducer that can approach this ratio correctly will sound more lifelike.

The HFS-2 has been developed to meet these demands as well as the other accepted criteria, such as extended and "flat" frequency response, low distortion and good transient recovery. It is effectively a four-way system. Bass, from 200 cycles down, is generated by the rear of an 8½-inch driver working into a slot-loaded conical horn (more on this later). The front of this driver's cone crosses over at 200 cycles, by virtue of its acoustic relationship with the rest of the system, and continues to respond to about 2,000 cycles.

A mechanical crossover then feeds signals in the range from 2,000 to 8,000 cycles to a free-edge, specially loaded cone, the outer boatlike object just inside (above) the driver in the cutaway photo and the cover picture. The range above 8,000 cycles is electrically divided by a 12-db/octave network consisting of a 1- μ f capacitor and a 150- μ h coil (Fig. 1), and fed to an independent driver (tweeter) whose design parameters resemble those of the upper mid-range unit.

Tweeter design

This tweeter radiates from both sides of the free-edge steep-sided vertical cone or cornet mounted above the 8½-inch speaker. The outer surface of the cone produces a 360° horizontal radiation pattern. Radiation from the inner surface provides the vertical component

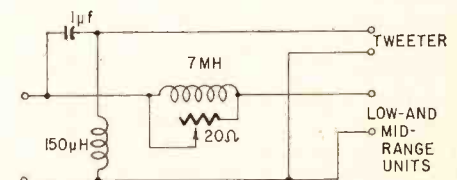
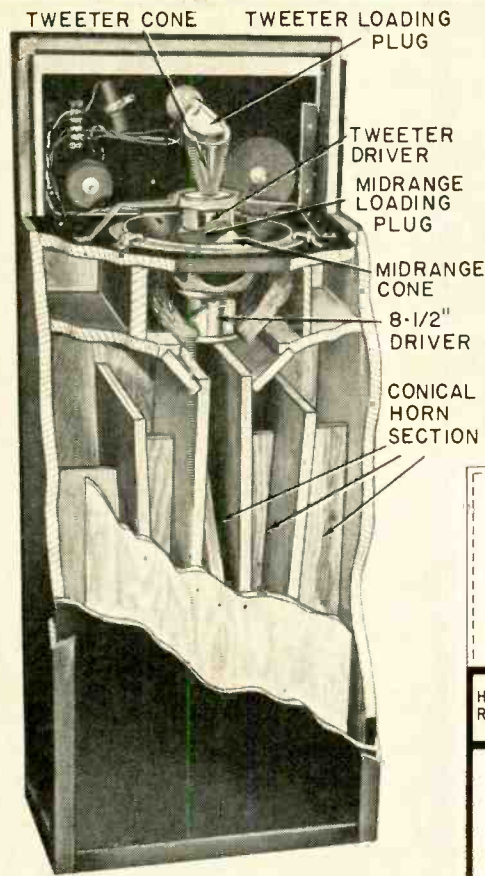
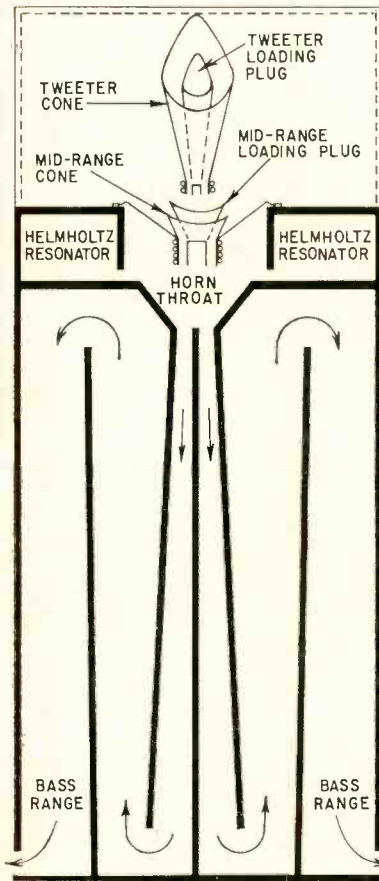

Fig. 1—Crossover network of the HFS-2. (Incidentally, this can be used only with an inherently well-damped system.)



Cutaway model of the Eico HFS-2

Section showing details not revealed in the cutaway photo



for a complete hemispheric dispersion pattern.

If this were a conventional vertical cone with an edge forming a right angle to the voice coil axis, it would have a relatively narrow-band response. What's more, the lateral radiation would all be in one plane while the vertical response would be beamed, not dispersed.

In this design the edge of the cone is so cut as to provide a constantly varying distance between the cone's edge and the voice coil. This broadbands the tweeter's response while smoothing it to avoid undesirable peaks. This shaping also spreads the radiation vertically so that it is not restricted to one plane horizontally.

To enhance this "umbrella" coverage further a rigid and nonmoving "acoustical loading cone" or "plug" is inserted concentrically within the radiating cone. This plug forms an air gap between itself and the inner surface of the radiating cone. This gap acts as a ring radiator. Because of the varying distance between its effective radiating surface and the voice coil, this ring radiator produces a desirable phase displacement between any two or more acoustical elements (air particles) in that gap. As a result of this displacement the radiation pattern from the tweeter takes on a hemispherical shape. An additional benefit from this plug is that it obviates any effects of response peaks or instability which might be caused by radiation from diametrically

opposite points on the inner surface of the radiating cone.

Finally, by mounting this configuration literally out in the open (see photograph), a practical omnidirectional sound source is created which represents a close approach to the theoretical ideal of a zero point source.

Mid-range design

The design principles used in the tweeter can be varied to provide correct response over different portions of the frequency range, still retaining the same optimum distribution pattern. In the mid-range reproducer element of the HFS-2 (known in its prototype form as the Hegeman Standard) it was found that the frontal radiation from the cone used for the low-frequency driver provided excellent response from

slightly below 200 to above 8,000 cycles. What was needed was to stabilize this response, eliminate any peaks, provide for the same hemispherical radiation pattern as in the tweeter and furnish a means of balancing the mid-range response with the high and low ends.

Another free-edge cone of special shape, with its nonmoving acoustical loading cone, is used to stabilize and smooth the response, as well as to produce the desired hemispheric radiation. The power response of this unit is such that it is inherently almost perfectly balanced with the high and low ends. To adjust this balance a specially designed control—the 7-mh choke and 20-ohm potentiometer of Fig. 1—changes the relative amounts of high- and low-frequency energy fed to the woofer and mid-range driver. With the resistor nearly shorted, all frequencies flow equally into the speaker. With it set near its full 20 ohms, the lower frequencies are favored. Its range provides sufficient variation to balance the system to suit most acoustic environments.

The bass reproducer

In all the literature of high-fidelity, no subject has been discussed and debated more than low-frequency reproduction. Readers of RADIO-ELECTRONICS are thoroughly familiar with the pros and cons of horns as against direct radiators. In selecting a horn for the bass element of this system, considerable weight was given to two advantages: The horn can provide an even wider pattern of sound distribution, and it can couple acoustical energy efficiently to the listening environment from a relatively narrow source (the speaker cone). Horns have their problems, too, but these problems are subject to solution, as we shall see.

Possibly no reproducer conformation has been as much abused in the literature as the conical horn. That type, it has been fashionable to point out, has a rapid rolloff in response and is therefore unsuited for hi-fi applications. What has not been pointed out—but what is quite apparent from even a cursory study of published curves—is that the conical horn remains far and away the smoothest responding horn known—even when it is rolling off.

The response curves for different horn shapes are shown in Fig. 2. The

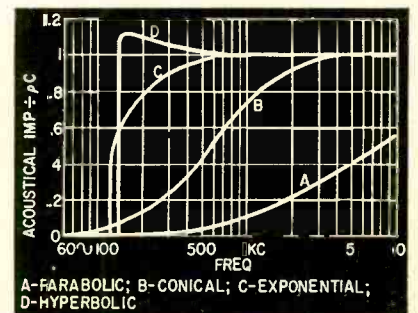

Fig. 2—Conical, hyperbolic, parabolic and exponential horns compared.

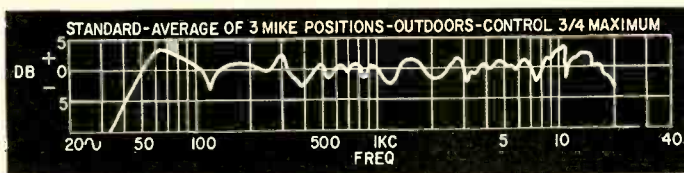

Fig. 3—Frequency response of HFS-2, or Hegeman Standard, speaker system.

conical horn begins to show its merits as a bass reproducer when one investigates carefully the behavior of horns near cutoff frequencies, and the use of horn mouths that are—in theory at least—inadequate in diameter. It is certainly true that the efficiency of a conical horn does begin to roll off at a higher frequency than other horn shapes, but that rolloff is very gradual, very linear. And it is equally true that the conical horn continues to respond—albeit at lower amplitudes—an octave below an exponential horn of equivalent size!

Further, if one accepts the general proposition that sharp changes in amplitude response represent large changes in phase characteristic and that gradual changes indicate that the phase characteristic is more linear, it is obvious that the conical horn must produce less coloration of whatever signals it is reproducing than can either a hyperbolic or an exponential horn. To put it another way: the smoother rolloff in efficiency of the conical horn represents a lesser change from the desired linear phase characteristic (so essential to natural reproduction) than is possible with an exponential horn.

There still remains, of course, the problem of horn mouth size for adequate bass response, and the efficiency at the very low end. Any horn has a natural cutoff point, determined by its length, mouth diameter and rate of flare. A horn would require a mouth diameter of 7 feet to reproduce 50 cycles. This is obviously out of the question for practical applications. "Folding" the horn to make it physically shorter and using the corner of the room to lengthen it acoustically do help. But there is a better solution.

Just as in transmission practice it is entirely feasible to replace, for example, a required section of telephone line with a properly devised termination, so acoustically it is possible to replace a section of a horn with a properly devised acoustic termination. At low frequencies, such a termination is represented by a narrow slot. Consequently, by replacing the mouth of a relatively short conical horn with a critically dimensioned slot, it is possible to cause the driver mounted at the horn throat to behave as if it were working into a horn of virtually infinite length.

The slot confines enough air within the horn to build up a suitable resistance for the driver (at the horn throat) to work against. At any point from the slot back to the driver, the air in the now shortened horn presents the same impedance to the driver as if the horn had continued to an optimum length

and mouth diameter for frequencies below 30 cycles. Additionally, the acoustic impedance now inside the confined horn produces a greater air pressure within that horn than in the room outside the horn.

As a result of this internal pressure, the slot functions acoustically as if it were many times its own area. Behind it, every movement of the speaker cone sets up relatively high compressions of small masses of moving air. These compressions provide the same acoustic energy as would otherwise be provided by large masses of air under less compression. The higher pressure within the horn—higher with respect to the normal pressure of the atmosphere in a room—results in a high particle velocity in the slot, causing the acoustic energy in the horn to be transmitted to the listening room with the effect and impact of a jet stream. The comparison, by the way, is no mere analogy—as anyone who has held a lit match near the slot during a heavy bass passage can testify!

This high-pressure technique permits getting the lowest bass tones from what might normally be considered a "small" bass driver—an 8½-inch cone.

Efficiency

Slot dimensions are chosen to provide optimum radiation resistance (highest efficiency) at the very low frequency end, just below 30 cycles. These dimensions, fortunately, also provide radiation resistance below optimum for the upper bass frequencies, reducing their efficiency to match that of the very low end. In this way, the entire bass line becomes essentially flat. In practice, loading extends to 20 cycles, producing a response that is smooth, full and clean—with no possibility of doubling. The net result, in effect, is a conical horn with no bass rolloff! And because its overall efficiency is comparable to that obtained from the radiators used for mid-range and highs, the entire system has a uniform efficiency throughout its range, as may be seen in Fig. 3.

What's more, the shortened horn length actually improves transit-time characteristics, so that the phase relationships of all bass tones are largely preserved.

The front of the bass driver is open to the same room into which the horn works. This introduces impedance variations which could result in peaks or dips in response. In effect, there can be a sort of acoustical short circuit, waves from the horn mouth cancelling (or reinforcing) those from the front of the driver. To overcome these variations, each side of the speaker cone—

where it works into the horn throat—is fitted with a small Helmholtz resonator (see the cutaway photo) tuned especially for this speaker-horn parameter. The resonator helps to smooth out the peaks and dips, and eliminate them as factors in the response. The resultant impedance curve shows a total variation of no more than 2 to 1, which is, obviously, much lower than that in conventional speaker systems. Such a low variation has a distinct advantage as the terminating load for an amplifier, since it makes less demand on the complex of damping, stability, recovery time, power reserves and response throughout the audible range. The HFS-2, consequently, can be driven by good amplifiers of any power rating.

The Hegeman Professional

The Eico HFS-2 was conceived originally as integrated speaker-enclosure system of relatively small size, to work well in the average living room. Additionally, two—for stereo—should not crowd out the other furniture or the occupants, yet it is not dwarfed performance-wise in larger rooms. Highly satisfactory stereo demonstrations, using two HFS-2's, have been given in halls seating about 750.

The HFS-2 should be judged by the same musical criteria that have been applied to its big-brother prototype, the Hegeman Professional. This speaker, available from Hegeman Laboratories only on special order, has been since its development four years ago, the trial balloon in which have been tested the various ideas and design parameters used in the HFS-2. In laboratory, as well as in practical applications in studios and many homes, these ideas and designs have proven themselves.

The Pro uses two 8½-inch bass drivers working into a huge, double-section, slot-loaded conical horn. The combined piston action of these drivers provides fundamental bass below 20 cycles. An electrical crossover at 200 cycles furnishes mid-range frequencies to two independent drivers; a second crossover at 8,000 cycles feeds highs to a tweeter. The speaker elements resemble physically those used in the HFS-2. END

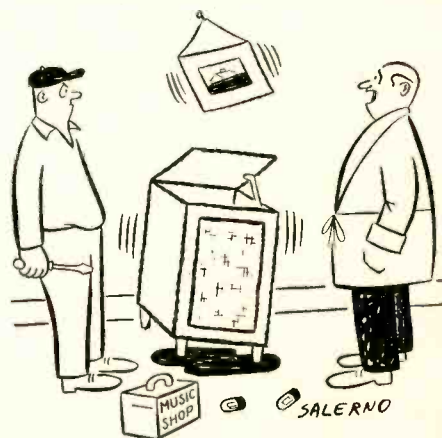

"It's still not right! I used to knock that picture off the wall at only half volume!"

new STEREO and MONAURAL

RECORDS and TAPES

Reviewed by
Chester Santon
Station WQXR
New York City

STEREOPHONIC records are now worthy of a review on top-grade equipment. This major breakthrough in the development of the stereo disc was touched upon last month with the mention of London's stereo demonstration record, PS-100. This pace-setting disc appeared during the first week in June. It is, in my opinion, the first commercial 45/45 product to approach the sound of the lacquer stereo record I heard last December on laboratory playback equipment. Subsequent first releases by other major record firms reviewed this month indicate progress but fail to match the presence, output level and quiet surface of the London recording. Reviewing these records by means of a belt-driven turntable and a moving-coil stereo cartridge, the full impact of the drastic change that has occurred in the stereo disc is clearly evident. Incidentally, for best results, I still use a monaural cartridge on my monaural records. When feeding the content of a monaural record to both channels, the 1-mil monaural stylus has a better signal-to-noise ratio than does the 0.7-mil stereo stylus.

A Journey Into Stereo Sound London FFSS Stereo Disc PS-100

This leading stereo record to date does much to explain London's absence from the stereo tape catalog. While many American firms were issuing stereo on tape, London steadfastly maintained its belief in the disc as the principal medium for stereo. In addition to excerpts from current classical and popular recordings, this sampling includes highly realistic sounds of racing cars, trains and the changing of the guard in the Tower of London. The lows, rivaling some of the better efforts on tape, are more clearly defined than those on previous stereo records. The highs above 8,000 cycles provide a stereo effect of greater depth than that found on most stereo tapes. An outstanding demonstration item is the Ansermet rehearsal of Stravinsky's *Rite of Spring*. Having heard advance copies of forthcoming complete London FFSS (Full-Frequency Stereophonic Sound) releases, I am satisfied that the quiet surface and wide frequency range of this surprising record are not an isolated accident.

The Stereo Disc

Capitol SWAL-9032

Capitol's introduction to stereo on records effectively copes with such sounds as New Year's Eve in Times Square, a Diesel locomotive, ferry boat and subway train. Convincing evidence of a uniform spread of sound is found in the bowling-alley sequence with the ball rolling from one speaker to the other with unchanging intensity of sound. On the last band of side 1, castanets are heard as a central pinpoint of sound for channel balancing. On the other side of the record, there are exhilarating stereo samples of the Roger Wagner Chorale, the Pittsburgh and Hollywood Bowl Symphony Orchestras, Fred Waring and other Capitol stars. This record and the two stereo discs that follow are recorded at a level slightly lower than that of the London stereo record. As a result, surface noise is occasionally apparent. Other advance pressings of the initial Capitol stereo record release include *The Young Person's Guide to the Orchestra* and the first American recording of the brand new *Symphony No. 11* by Shostakovich. I am reserving judgment on the matter of noise level in

the soft passages of these classical releases until I have a chance to hear the regular pressings.

Deutschmeister on Parade Julius Herrmann conducting Deutschmeister Band Westminster Stereo Record WST-15007

The first Westminster record to reach me revives acquaintance with the unusual talents of the Deutschmeisters, already heard by many on monaural disc and stereo tape. The stereo effect here is much the same as that on the tape with the frequency range virtually equal to that of the monaural disc. Informal, carefree artistry such as this scarcely calls for expensive preservation on stereo tape when such sound is available on stereo disc.

Stereovox Sampler

Vox VST-1

\$2.98 will let you know what Vox is doing in its first stereo records. At the moment, on the basis of this test pressing, they are trailing behind the labels mentioned above. This disc's sound effects—a sports car race, crowd noises and a New York City Civil Defense alert—are lacking in the presence that makes stereo exciting. Most of the music, performed by the Bamberg Symphony Orchestra, though enhanced by the second channel does not measure up to Vox' generally excellent monaural standard. In the case of symphonic music on stereo discs, it's still early in the game. Other major firms have scheduled their first stereo releases for late in August.

Music for Heavenly Bodies Paul Tanner, Electro-Theremin Andre Montero and his orchestra Stereo Omegatape ST-3016 (7-inch; playing time, 43 min. \$14.95)

Related to the Theremin family, the electronic instrument used in this tape represents the experiments of two Hollywood technicians. Unlike the regular Theremin where the player's hands move in the air without touching the instrument, the variable oscillator of this Electro-Theremin creates sound as the player operates a slide. It is the brain child of Paul Tanner, a trombonist formerly with Glenn Miller's orchestra. The audio range of the Electro-Theremin is stated to be from zero to over 20,000 cycles. Mixed with the conventional instruments, it should look more interesting on a scope than it sounds to the ear. The novelty of the arrangements hardly merits a tape of this length and price.

Sounds What Sounds!

Stereo Omegatape ST-2021 (7-inch; playing time, 22 min. \$11.95)

This is a slow-starting entry from the stables of Robert Oakes Jordan and Jim Cunningham, the team responsible for many of the stereo sound effects found on demo tapes these days. The second half of this tape is more interesting than the first. The carillon at the University of Chicago and a parade at a Shriner's convention are given adequately realistic frequency response. The reel hits its stride in the last two items. In the *Tic Toc Fugue*, the ticking of a pocket watch is superimposed on its own sound that has been slowed down eight times. It is claimed that some of the components go down

to 8 cycles. The tape comes to a climax with a Midwestern thunderstorm that is a corker. Bring up the gain to discover what may be the most violent transients in captivity today.

HANDEL:

The Messiah (Excerpts, Vol. 2) Thompson Stone conducting soloists, chorus of Handel and Haydn Society of Boston, Zimmler Sinfonietta Boston Stereo Tape BO-10F (7-inch; playing time, 30 min. \$11.95)

Whenever mixed forces on a grand scale are employed by a composer, stereo is the preferred recording medium. These nine excerpts from *The Messiah*, parts of a performance issued in 1955 by Unicorn Records, underline stereo's usefulness in separating and clarifying the individual complexities of the orchestra, organ, chorus and soloists. The important bass frequencies that carry the weight of this music are fully captured here. Another tape bonus is the absence of annoying peaks in the reproduction of the soprano voice.

Note: Records below are 12-inch LP and play back with RIAA curve unless otherwise indicated.

The Instruments of the Orchestra Vanguard VRS-1017/18

This two-record album features the first-class men of a symphony orchestra demonstrating the range and special characteristics of their musical instruments. The basic idea underlying the album is not a new one but the discs deserve wide circulation for several reasons. The sound is excellent, clean and very flat in response, and superior to other recordings of this type. The more detailed exploration and illustration of the various techniques possible with each instrument will add to the listener's enjoyment of the realistic recordings appearing today. So thorough is the coverage that in the string section alone 50 examples are offered, 21 of which are devoted to the violin.

Modern Jazz Concert Orchestra conducted by Gunther Schuller and George Russell Columbia WL-127

One of the more subtle challenges that can confront a clean-sounding system is ultra modern jazz of unlimited horizons. The six new compositions on this record were commissioned by the 1957 Brandeis University Festival of the Arts. Based on musical forms used in past centuries, they include some of the most advanced and rare tonal experiences available today. Not for the newcomer in jazz or audio.

STRAVINSKY: *The Rite of Spring* Igor Markevitch conducting Philharmonia Orchestra

Angel 35549

The haunting first notes of the bassoon tell us that the typical closeup studio miking generally used by Angel for the Philharmonia Orchestra is being employed. Every formerly hidden crevice in the instrumental fabric is sought out by these mikes. The sound of tympani and bass drum, so prominent in this score, is softer in contour at this distance yet no less satisfying in profound lows. Good pacing by Markevitch.

Ella Fitzgerald Sings the Duke Ellington Songbook Duke Ellington and orchestra

Verve MG V 4010-4

This four-record deluxe album provides an ideal point of entry for the new audience now taking an interest in jazz. We can understand why Ella Fitzgerald is one of the most highly admired jazz vocalists of the day because she sings with infinite understanding the Ellington classics of the past 30 years. Ella and various combinations of the Ellington band are recorded in remarkable closeups. The liveness of the acoustics and the buoyancy of her singing go well together. The album is split in to Vols. I and II, available separately. Fitzgerald-Ellington fans have a wealth of popular and jazz favorites from which to choose. END

Name and address of any manufacturer of records mentioned in this column may be obtained by writing Records, RADIO-ELECTRONICS, 154 West 14th St., New York 11, N.Y.

Chasing the Gremlins out of Kit Building

By IRVING BECKER*

KIT building is constantly growing in popularity. Not only is it a way of saving money while acquiring high-fidelity components, amateur radio equipment and test instruments, but to many it is an end in itself. Its relaxing, therapeutic value in the evening or on weekends is not to be denied.

On the other hand, a completed kit that fails to work is frustrating. Therefore, manufacturers concentrate on designing a physical layout and carefully organized step-by-step instructions which will enable a novice to assemble the kit successfully if he adheres to instructions. Nevertheless, a small percentage of kit builders fall short of success. For these, the responsible manufacturer offers a repair service at a reasonable fee, assuring the customer that his instrument will be repaired and aligned. However, both the manufacturer and the customer would be happier if the demand for such service could be reduced.

With this in mind, here are a description of how we at Arkay seek to maximize the constructor's chance of success and some tips to the kit-building public on chasing the gremlins out of kit building. (These gremlins are usually found lurking in dark corners of the chassis.)

I feel that failures would drop very close to zero if the purchaser followed instructions to the letter. Possibly some of those who have built kits may have a different view. If this article stirs such individuals to voice their opinions as to how kits could be improved, their thoughts should be of value to kit manufacturers and ultimately to future kit builders.

In designing a kit, every attempt is made to make it foolproof. The first units are assembled by persons without previous kit experience, electronic knowledge, soldering ability or special mechanical aptitude. The results of these trials are used to rework the kit

*President, Arkay, Inc.

Kits are easy to build, if you avoid wandering away from the instruction sheet. Some of the troubles you may encounter and what can be done to prevent them are discussed

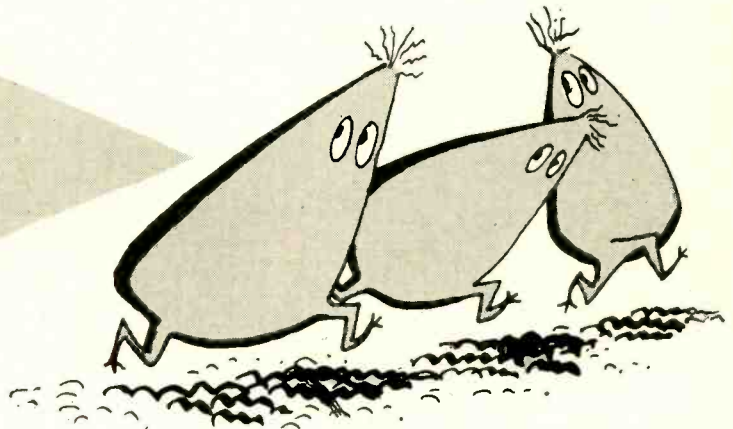

and the assembly instructions until it is proven that the instructions are easy to follow and if followed will result in equipment that operates satisfactorily.

If the design and instructions are eliminated as sources of trouble, the only other cause for failure attributable to the manufacturer is a faulty part—for example, an off-value resistor or a shorted capacitor. To minimize such failures, parts are purchased from reliable sources and the quality of incoming supplies is checked on a sampling basis. The bulk of the returns, under 1% of sales, are due to a mistake the builder has made. Of course, we would be happier if the percentage of returns were even smaller, and I feel this could be achieved by proper care on the constructor's part.

If the kit builder is successful, he is encouraged to go on to other kits, and so are his friends. Failure has the opposite effect. To would-be builders who have been deterred by the possibility or experience of failure, the following suggestions on chasing gremlins out of kits should greatly increase their courage and chances of success.

The soldering problem

Improper soldering is the greatest source of trouble, accounting for perhaps 80 to 90% of all returns. Soldering is an art but, so far as electronic kit building is concerned, it can be adequately mastered in a short time. Here are a few pointers:

A soldered connection should appear bright and smooth, never dull and rough. The latter indicates a poor connection, known as a cold solder joint, and is usually caused by insufficient heat or moving the joint while cooling. The result may be an intermittent electrical connection, no electrical connection at all or one with high resistance.

A good brand of rosin-core solder should be used. *Acid-core solder is taboo for electronic equipment.* A 60-40 solder (60% tin, 40% lead) is preferred and, though it may cost a little

more, it is definitely a worth-while investment. This solder melts at a lower temperature, adheres better and generally gives greater assurance of a good electrical connection than 50-50 or 40-60 solders.

The soldering iron should be clean and well tinned—its tip covered with bright-looking solder. When dirty, the tip should be cleaned with a fine file and retinned.

The lug or other point to which a part, such as a resistor or capacitor, is being soldered should be hot enough to melt the solder. For example, heat the lug with your iron and apply solder to the lug. The solder will not melt until the lug is hot, thus insuring a good connection.

Avoid excess solder. If too much flows onto a connection, remove the excess with the tip of the iron or a screwdriver. However, enough solder to fill completely the space within a lug should be used.

Too little heat is a frequent source of difficulty. In soldering one or two leads to a lug, a 25-50-watt iron is usually sufficient. But if the lug is connected to the chassis, which quickly drains the heat from the iron, 100 to 150 watts is desirable. Therefore, it may be necessary to switch from a low-wattage to a high-wattage iron while assembling a kit. A high-wattage iron is also necessary when soldering a large number of parts to one lug. In these situations you may get away with an iron of about 50 watts if you let it heat for a while and then solder very quickly, before the heat drops. Remember to let it heat again before going to the next connection or you risk a cold solder joint.

Too much heat can also cause problems. When using an iron that produces much more heat than called for, work quickly. A high-wattage iron applied too long to the lug of an if transformer can burn out the transformer wire where it joins the lug. When soldering a shielded cable, ex-

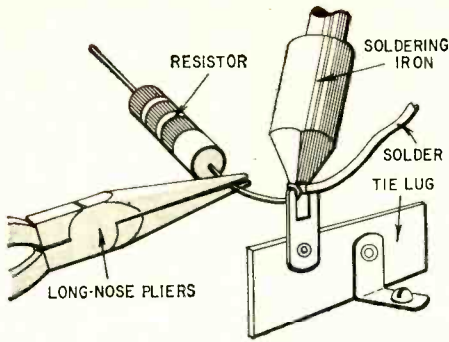

Fig. 1—Using long-nose pliers for a heat sink will save resistors and capacitors.

cessive heat can melt the insulation around the inner wire, causing a short between the inner and outer conductors. Excessive heat can cause resistors to become noisy and change in value. To be safe, a heat sink should be used when working with components which may be damaged by heat. One method of doing this is to clasp the component's lead with long-nose pliers at a point between the soldering iron and the body of the resistor (Fig. 1). However, this will sometimes call for three hands. Instead of pliers, you can use an alligator clip to which a piece of heavy wire has been soldered, as in Fig. 2. This device, of course, is self-clamping.

Once the soldered connection has been made, do not disturb it until it has cooled and hardened. Otherwise a cold solder joint, dull gray in appearance, will result. If this happens, the solder should be remelted and allowed to harden again.

Lead dress

Correct lead dress is not a matter of making the underside of the chassis attractive but is a means of getting the circuit to operate properly, especially in a tuner or high-gain amplifier.

Some of the kits returned for repairs contain excessively long leads, a veritable hornet's nest of wiring. Where short leads are essential to correct operation, the instructions specify the shortest lead possible (see Fig. 3). Still, some constructors depart from instructions and pictorial diagrams by making very pretty right-angle wiring where it isn't called for. This may look good, but often doesn't work right. It adds inductance, which can seriously change the resonant frequency of a circuit in an FM tuner. Lead inductance can also cause hum or signal pickup, the latter possibly resulting in positive feedback and oscillation.

Leads should be routed according to instructions. If the manual says to dress the lead tight against the chassis, there is no excuse for doing otherwise. Yet kits are returned with a network of wires hovering in the air, acting like little antennas to pick up hum and other troubles.

A little inattention to the instructions for use of insulated sleeving (spaghetti) can cause much trouble. Omission of spaghetti can let one lead

contact another or short to ground. The result may not only be an unworkable kit, but is more likely to be destruction of various parts such as resistors, tubes and transformers.

Haste makes waste

Kit instructions are spelled out in a large number of easy steps so that the beginner can put together a complete instrument. This detailed procedure does not appreciably increase assembly time. Regardless of how the instructions are presented, the same number of parts would have to be mounted and the same number of connections made. Yet in a number of returned kits, there are obvious signs of impatience with the deliberate pace of the instructions. The builder has gone ahead on his own, soldering this part or that before the manual told him to do so. And mistakes are the usual consequence.

This is even more likely to happen if the builder is an engineer, a physicist or some other individual with claim to an advanced knowledge of electronics. On the other hand, the gentleman who

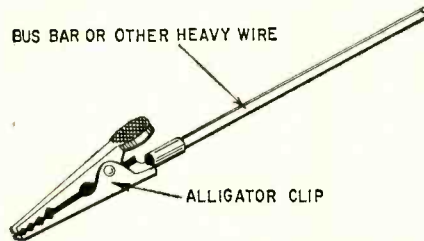

Fig. 2—Where you need three hands, this heat sink with its own fingers is a valuable aid.

drives a truck and has learned to obey road signs is apt to produce a careful, neat job, showing all the indications of scrupulous conformity to instructions. True, the latter's kit might not have been returned had he not run into some kind of difficulty, but typically this difficulty is of a simple sort, easily detected and repaired at minimum cost. Or there may not even have been an error. For example, a tuner may have been returned only for alignment. However, the impatience of the electronics expert with the assembly procedure may lead to serious mistakes.

Arkay's service technicians have become adept at reading the kit-builder's character by looking at the wiring of his kit. Sometimes they find very neat work at the outset of the project, moderately neat work midway and sloppy work thereafter—all

the signs of the person who soon grows impatient and bored.

Some constructors don't even finish the job. Equipment is returned with parts unmounted, dials unstrung, etc. There is no need to complete a kit in one or two nights or even one or two weeks. There is no race and no prize for the fastest building time. There is no more purpose in dashing through a kit than through a fine book. The pace of the work should be adapted to the builder's temperament and spare time. Rushing to complete a kit can lead only to errors and the expense of having them corrected. There is no problem in resuming interrupted work on a kit, because the instructions constitute a check list, and you simply start again with the step after the last check mark.

A measure that may save time overall, although it adds to the time of each step, is using an ohmmeter to check connections during construction. Where a lead goes directly from one point to another, the ohmmeter should read zero resistance between these points. If a resistor is connected between two points, the meter should read the resistor value. If a capacitor goes between two points, the meter should read infinite or very high resistance, unless there is also a resistor between the same points.

Transistor equipment

Transistors are finding their way into kits as well as ready-made equipment. Usually the manufacturer provides a socket to hold the transistor. The constructor should not put the transistor into the socket until all soldering has been completed.

If the temperature in the immediate vicinity of the transistor goes above 120°F, it may be damaged. Although the equipment will be designed to prevent this much heat near the transistor, the situation is not entirely under the kit manufacturer's control, because the constructor may place the kit in a place where ventilation is poor, causing heat to build up to an unusual degree. Be extra careful and make sure there is plenty of air space around any kind of transistor equipment. If the manufacturer suggests adding a heat sink, do so, following his instructions.

In case of trouble

If the instrument fails to operate properly after assembly and alignment, review the work, step by step. The mistakes you will ordinarily find are cold

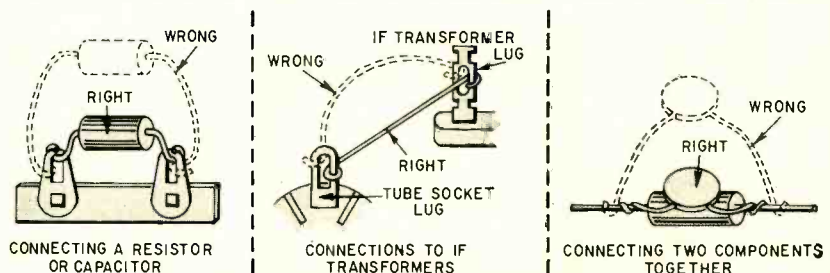
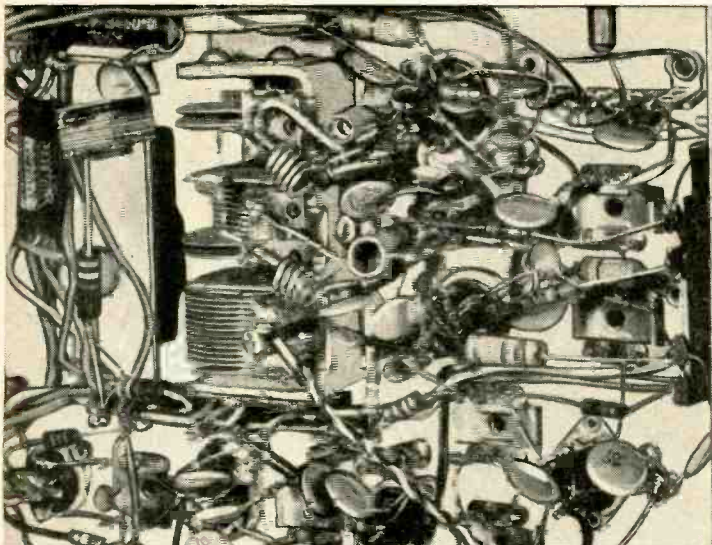
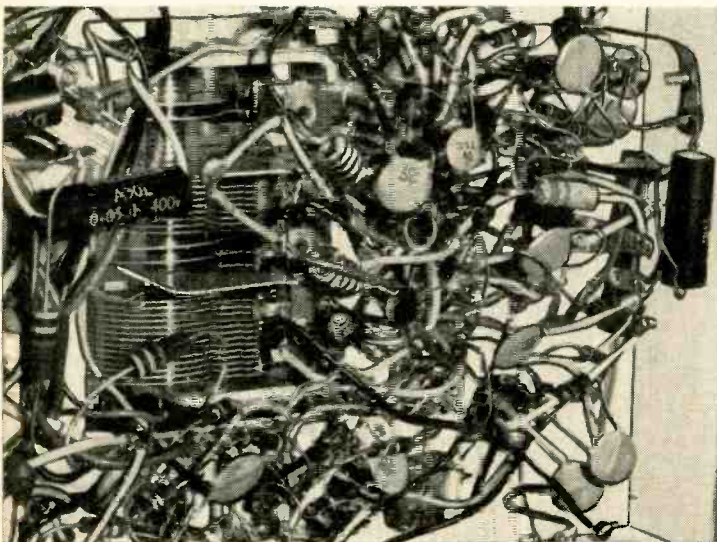

Fig. 3—Short leads are sometimes vital. Here are some ways of getting the desired results.



The right and wrong ways of wiring a kit. (Top) Following the step-by-step instructions gives you a kit that is neat and operates properly. (Bottom) A prime example of how not to wire a kit. Parts are jammed in every which way and the result is a unit that does not work as it should.



solder joints, unsoldered connections, resistors or capacitors interchanged, parts connected to the wrong points, parts omitted, transformer color-coded leads mixed up.

It may turn out that a power transformer lead fails to make an electrical connection because the enamel has not been scraped off the lead. Sometimes a builder will mount a tube socket from above the chassis instead of inserting the socket from below. Mounting from above shorts the socket lugs against the chassis. An occasional misadventure is that a kit builder may construct the equipment inside out. That is, everything that should have been mounted on one side of the chassis is mounted on the other side. This is more apt to occur in "flat" equipment, where the chassis is in a vertical rather than horizontal plane. Here the kit builder may make the mistake of mounting on the front of the chassis the components that are supposed to be on the back, and vice versa.

We all have blind spots, and one may

occur in building a kit. It is typical that in reviewing one's work for the cause of a malfunction, the same blind spot will recur again and again. If the constructor can get a friend to check the work on the kit, it is quite possible that the friend will find in a matter of minutes an error that the constructor might not find in hours. Some individuals have a false pride that keeps them from calling for assistance. In the case of the engineer or physicist, this is apt to be particularly true. They simply don't like to admit being stumped by what they consider an elementary piece of electronic equipment.

Voltage and resistance readings are usually supplied in the instructions, and, if you own or can borrow a von or vtvm, you can check these readings at the designated points. When resistances or voltages differ appreciably from the rated values—more than 20%—there is strong probability of a mistake in wiring or of a defective component. If these differences are confined to just one part of the circuit, the mistake

is very likely in that region, and a step-by-step check of your work in that area is called for.

If the constructor cannot track down the source of difficulty, he is naturally reluctant to pack his kit, mail it to the manufacturer and wait several weeks for its return. There is a strong temptation to bring it to a local service shop. However, this may be much more costly and less effective than returning it to the manufacturer. No slight is intended upon the abilities of the local technician. But he is accustomed to repairing equipment that was wired correctly originally and operated properly. The kit you bring in may be his first encounter with this instrument, and he may spend hours, at your expense, comparing your work with the circuit diagram until he finds the mistakes. On the other hand, the manufacturer's service technician is completely familiar with the kit and can generally spot the trouble in moments instead of hours.

Before you return a kit to the manufacturer, write him a letter stating your difficulties. For your sake as well as his, type the letter. Describe all the symptoms in orderly 1, 2, 3 fashion. If he cannot fathom the source of your problems, he will ask you to return the kit for servicing, at a moderate charge.

Because of careless packing on the kit builder's part, sometimes the greatest damage to the equipment occurs when he ships it back to the manufacturer. The kit should be placed in a carton a few inches bigger in each dimension than the kit, and this space should be filled in with crumpled or shredded newspaper. It's a good idea to save the original carton until the kit is finished. This box is ideal for returning the unit, should such a step become necessary. Railway Express, although more expensive than parcel post, gives best assurance of intact arrival. If you do ship by parcel post, take extra precautions in packing and mark the carton fragile.

The unnecessary return

While most returns are justified, a certain percentage could easily be avoided. Incredible as it may seem, some customers return an entire kit because one or two small parts, such as a couple of resistors, are missing. If such parts have inadvertently been omitted, the manufacturer will take your word for it and send them to you without charge.

Sometimes a kit is returned in which everything has been correctly assembled, but the tubes are in the wrong sockets. Occasionally an AM-FM tuner is returned as inoperative because the customer failed to connect an FM antenna in the mistaken belief that the AM antenna (ferrite loopstick or wire loop) also serves for FM. Sometimes a kit is returned with no signs of anything wrong. We can only guess that the customer failed to connect the power plug to the house line or that a tube may not have been inserted securely into its socket. END

HOW to SERVICE

Finding troubles in transistor radios is easy, if you know what to expect

TRANSISTOR

RADIOS

By H. V. STEWART*
and C. W. LIGHTFOOT*

THE ever-increasing popularity and production of all-transistor radios has opened a new field for the service-technician. This new field, although limited in volume because of the near-infinite life of the transistor, requires new techniques and basic skills. Just as a fine watch will last a lifetime if it is cared for reasonably, so will an all-transistor radio. The amount of servicing required by a fine watch is seldom more than cleaning and adjustment unless it has been mistreated. The all-transistor radio is proving to be very much the same. The transistor has shown it has very long life. Failure is definitely the exception rather than the rule.

99.9% of all repairs . . .

The troubles experienced in the field with the all-transistor radio fall into three basic areas which cover 99.9% of the complaints. Most common of all are difficulties associated with the battery in some way. These may take several forms—from a dead battery to one installed improperly (usually inserted backward).

*Application engineers. Texas Instruments Inc.

Intermittent contacts are common, particularly when cells are left in the radio until they leak, corroding the contacts. The unusually long battery life in transistor radios contributes to these difficulties. Owners tend to lose track of the length of time batteries have been in service, so they are left in the radio after they should have been replaced. As a general rule, when the voltage across the battery supply, with the set on, drops below 75% of the rated voltage, replace the batteries.

The electrolytic capacitors used in transistor radios are the second cause for service. Miniature packages and circuits require low-voltage high-capacitance dry electrolytics. Decreasing in capacitance with age, these units are a common cause of motorboating, oscillation, no output, reduced output and distortion. Audio coupling capacitors (usually 2 to 5 μf) in older receivers have been known to drop to less than 0.5 μf , seriously impairing the receiver's output. Constant research and improvement of these components have lessened this complaint in later receivers. Low-voltage high-capacitance electrolytics can be damaged by reversing the supply of voltage polarity or ap-

plying some potential above their voltage rating.

Breaks in printed-circuit-board conductors, poor electrical connections and cold solder joints are the third major cause of service in the transistor receiver. Voltage and continuity measurements made while gently flexing the chassis or printed-circuit board will usually pinpoint the trouble.

Working on the printed circuit

Major breaks in printed-circuit boards require special tools, equipment and material to make a new board. This type of repair is best done by the manufacturer's service department. A single break in a printed lead can be repaired by soldering a short jumper of tinned copper wire across the break.

The techniques needed to repair printed-circuit transistor receivers do not differ from those used on printed-circuit vacuum-tube receivers. For instance, only enough heat to melt the solder quickly should be used. The 37.5-watt pencil type soldering iron is adequate for most circuit work. However, if a larger iron is needed to melt the solder quickly, it should be used, but only long enough to make a good solder connection.

Excessive heat will blister the printed-circuit board and raise the ribbon from its insulating base. Excessive heat applied directly or indirectly to transistor leads can permanently damage the transistor. When heat is applied directly to the transistor leads, heat-sink the leads with long-nose pliers.

Always be careful

Less than 1% of the transistors in radios require replacement under normal use. However, while servicing transistor radios the transistors can be destroyed or damaged by applying excessive or prolonged heat to their leads,

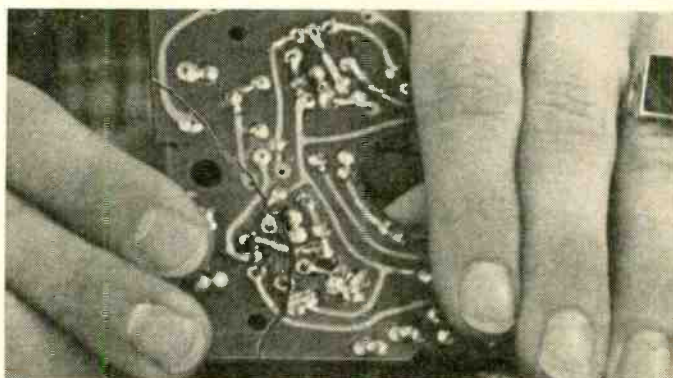

Flexing the printed circuit board will reveal hairline cracks that can cause intermittent operation.

RADIO

connecting an incorrect battery potential to the circuit, shorting elements by connecting meters and scopes in the circuit and by shorting elements with solder splashes.

If there is no indication of receiver failure due to battery strength, battery polarity, opens or shorts in the circuits, use your vtvm to evaluate the transistors. Using the ohmmeter section of a vtvm, the diodes in a good transistor (base to emitter and base to collector) will show a front-to-back ratio of 100 to 1 or more. Do not use a vtvm that uses more than 3 volts for measuring resistance or you may damage the transistor.

Voltage and current checks

Voltage measurements in the transistor receiver should be made with respect to the transistor's emitter. For p-n-p transistors the base should be negative with respect to the emitter by approximately 0.2 volt. The collector will be negative in an amount determined by circuit design. For n-p-n transistors, the base will be positive with respect to the emitter by about 0.2 volt while the collector will be positive by an amount determined by circuit design.

Current values in a transistor circuit can be determined by measuring the voltage drop across the emitter resistor and calculating the current, using Ohm's law.

The initial current should be measured with the volume control fully advanced, the tuning gang at minimum capacitance and no signal applied.

The current value in each stage will vary even with transistors of the same type, so only average values can be stated.

Fig. 1-a is a typical transistor converter stage. Voltage E1 divided by the emitter resistance will be the emitter current in this stage. This current will average 0.5 ma (0.4 to 0.6 ma). In a normally operating converter stage, emitter current will show a 10% increase at the high end of the band over the value at the low end. This change should be linear and smooth. Any erratic change indicates oscillator malfunctioning. E2 should read 0.2 volt positive with respect to the emitter.

When soldering a new transistor in place, use long-nose pliers between transistor and board as a heat sink.



Lifted foil on printed-circuit board (spotted on left) was caused by excessive heat due to too-big soldering iron (upper right). At lower right a piece of braided wire replaces damaged section of printed wiring.

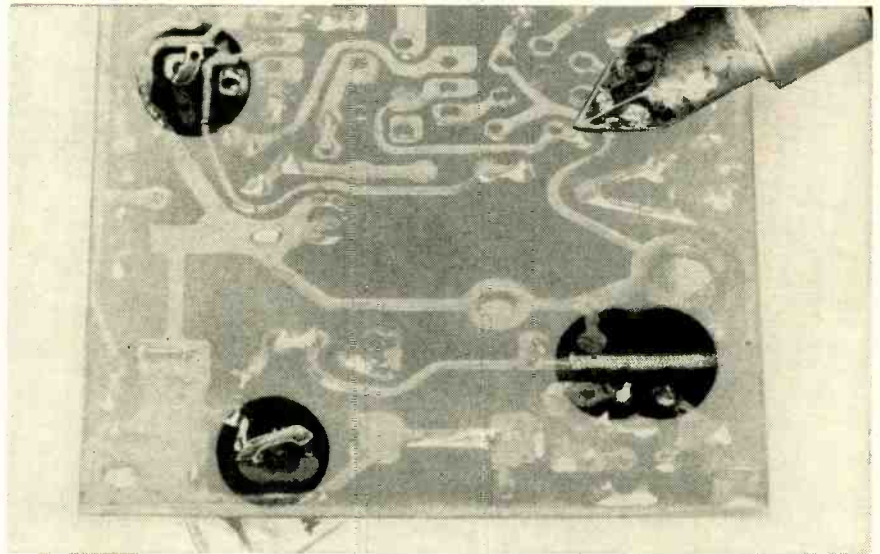

Normally, the base is negative with respect to the emitter but the positive reading indicates the oscillator portion of the stage is functioning.

Fig. 1-b shows the if and detector stages of a typical transistor receiver. E3 divided by the emitter resistance will be the emitter current in the first if amplifier and should average 0.5 ma at zero signal input. When signal is applied to the receiver, this current should decrease in proportion to the signal applied until cutoff occurs at about 50 mv per meter. If the current in this stage increases with signal level, the detector diode is installed backward. E4 will be

0.20 volt with the base negative in respect to the emitter.

E5 divided by the emitter resistance will be the emitter current in the second if amplifier and should average 1.0 ma (0.75 to 1.25 ma). This current should remain constant with changes in signal level. E6 will be 0.20 volt with the base negative with respect to the emitter.

Fig. 1-c is the audio driver stage of a typical transistor receiver. Emitter current, found by dividing E7 by the emitter resistance, should average 2.0 ma. E8 should be approximately 0.20 volt with the base negative in respect to the emitter.

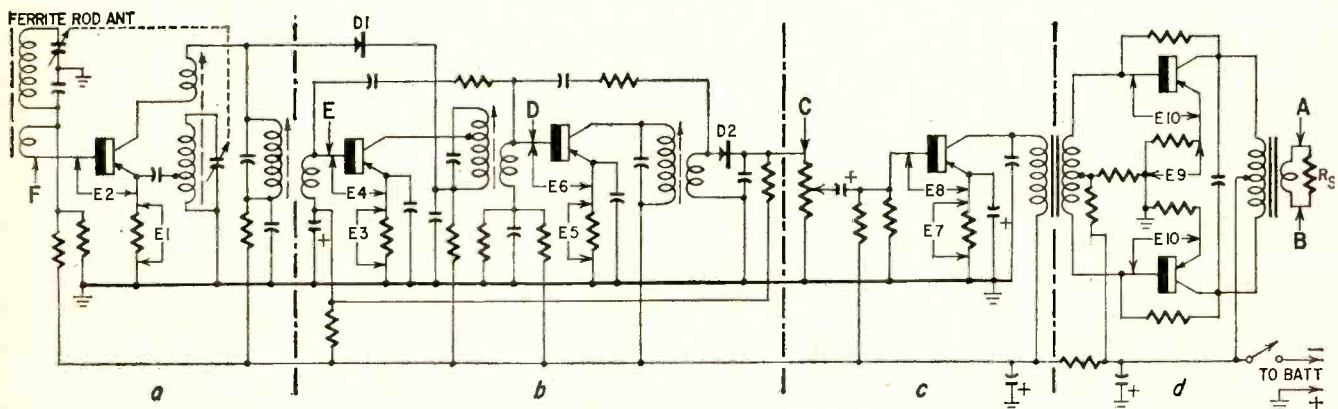

Fig. 1—Circuit of a typical transistor radio: a—converter stage; b—if amplifier and detector stages; c—audio driver stage; d—audio output stage.

Fig. 1-d is a class-B audio output stage with separate emitter resistors. (In some receivers a single emitter resistor may be used.) E_9 divided by the emitter resistance will be the emitter current in this stage. This value will be low at zero signal input and should increase with signal level. These values vary, depending upon the battery voltage used. E_{10} should read approximately 0.2 volt with the base negative with respect to the emitter.

Most manufacturers specify the power level of undistorted and maximum output of their receivers. Undistorted power output is that level at which clipping on upper and lower peaks begins to occur. Maximum power output is square-wave power.

To make these measurements, disconnect the speaker and measure the dc resistance of the voice coil. This value will be R_s as shown on the diagram. Connect the voice coil leads of the output transformer across a resistor with the value of R_s .

Connect an oscilloscope and a vtvm across R_s . These points are shown as A and B. Connect the output of an audio oscillator through a small electrolytic (2-10 μ f) to point C. Apply a 400-cycle signal and read the ac voltage at the point of clipping and at maximum output. The power output can be found by Ohm's law.

Signal substitution in the transistor receiver is much the same as in the vacuum-tube set. The output of a standard AM signal generator is connected through a 100,000-ohm resistor to point D. A modulated if signal is applied with only sufficient amplitude to produce an output power less than the clipping level. At this time the output if transformer can be aligned, if necessary. When this signal is applied in the same manner to point E, a definite gain will be observed. At this point the interstage if transformer can be aligned if necessary. The signal is then applied, in the same manner, to point F. Again, a definite gain will be observed. At this time the input if transformer can be aligned, if necessary. Finally, signals should be radiated into the antenna through a loop and the receiver aligned as recommended by the manufacturer for optimum performance. If anywhere along the line, going back a stage does not give increased gain, the stage must be bad.

When replacing parts . . .

Use an exact replacement part if any component must be changed. This is especially true with coils and transformers. These match certain transistor parameters to the circuit used. No universal replacements for these parts are available.

By using reasonable care and following the precautions outlined here, servicing transistor receivers should be no more difficult than working with tube circuits. If any doubt exists, most set manufacturers will be happy to supply information on their circuits. **END**

. . . and Now, the CRYSTAL SET!

AT last it's here! One of the most incredible inventions of our century! For the first time ever, a *lifetime pocket-size portable radio* that uses no batteries, no tubes, no transistors . . . in other words, **A MIRACLE RADIO THAT NEVER WEARS OUT—AND PLAYS FOREVER!**"

Thus begins a full-page advertisement in a New York newspaper, revealing the startling facts about an amazing new product of the atomic age (at \$4.95 plus postage).

What is it? Why, the lowly crystal radio of the early 1920's—all decked out in modern dress and atomic-age press-agentry.

Nowhere does the ad use the word "crystal"—and veterans of the cat's-whisker will be interested in this description of the scientific breakthrough which now makes possible a tubeless, batteryless radio:

"Recently while working on a military problem, scientists developed a new type of self-powered rectifier called a **GERMANIUM DIODE** . . . the same miracle invention now being used on all radar and sonar equipment. This new invention actually generates its own power by drawing electric waves **RIGHT OUT OF THE AIR** just like a magnet, and converts those waves into power-producing electricity!"

Here's a further explanation, which you'll never find in any radio course:

"It is this amazing electronic discovery that finally makes it possible for you as a civilian to own a lifetime pocket radio. . . . Because instead of bulking up a radio with all sorts of expensive parts and tubes, scientists have actually condensed an entire radio powerplant into this one single part that is no bigger than a dime, that generates more power than 1,000 batteries and that never wears out no matter how much you use it. Because, incredible as it may seem, each time you use it, it draws in more electric power from the air. It then feeds itself a new 'electrical meal' and stays just as powerful as when it was brand new!"

Not only will this hungry radio gobble electrons from the air in your own home, but for the same sawbuck the advertiser says he'll throw in "two bonus features—features you'd ordinarily expect to find only on extremely expensive hi-fi sets!" These are a "ferrite loop antenna" and a "direct circuit personal earphone speaker" (no loudspeakers on crystal sets, of course).

This miracle radio, says the ad, "pulls in programs as sharp and clear as though you were sitting in the broadcasting studio," and it's "so powerful

it picks up broadcasts from as far as 10 cities away" (North Dakota editors please note).

But before you throw away your old, out-moded tube or transistor radios, and substitute these glamorized, slenderized crystal sets, it's a good idea to try one.

They work pretty good, like a crystal set should.

Given enough antenna, the ones we've tried will bring in two or three stations in the heart of the city. Which stations they are, you can't tell until you hear the identification (no calibrated dial, of course).

As toys or novelties, the "new" crystal sets are lots of fun. Using a germanium diode as a detector and with inductance or capacitance tuning, they're generally housed in attractive plastic cases, usually are Japan-made. Prices range from \$2.95 to about \$5.

(We didn't have an opportunity to test the crystal set advertised so flamboyantly. On the basis of consumers' complaints, the New York State Attorney General obtained a temporary injunction barring the sponsors of the ad from doing business while the state seeks to dissolve the company on charges of fraud).

These new "miracle" diode radios are flooding the country. So if the whoope-de-do about the "radio that lasts forever" hasn't yet reached your area, brace yourself and prepare for the greatest scientific breakthrough since the invention of smoke signals.

This is truly the age of electronic miracles: From wireless to radio broadcasting, to TV, to hi fi, and now—

The crystal set! **END**



"Now this model not only awakens you, makes the toast and coffee, but also sees to it that you get out of bed!"

Looking in on

LONDON



TV dx reception across the Atlantic is possible with the right equipment. Here's how to convert an old receiver to pick up those European stations

By **HARTLAND B. SMITH, W8VVD**

DURING my 18 years as a licensed radio amateur I have had many exciting dx contacts. I can honestly say that none of these gave me quite as much of a thrill as when I first saw an identifiable transmission direct from London on the screen of my own TV set. The realization that I was watching an event which was taking place almost 4,000 miles away, across the Atlantic Ocean, was truly a breathtaking experience.

Almost as remarkable was the ease with which I got this dx TV reception. My relatively simple equipment included a slightly modified ancient 10-inch television receiver, a pre-world War II FM tuner and a couple of indoor antennas. With this gear I picked up many telecasts from Britain during December, 1957, and January, 1958. With a little luck, patience and ingenuity, the average electronic experimenter should be able to duplicate or better my results this coming winter. The photographs are typical of the kind of reception I got. All broadcasts came from London.

TV dxing is not recommended as an

avocation for beginners. However, if you know your way around a TV chassis, are acquainted with high-frequency receiving techniques and have successfully constructed a few pieces of electronic gear, you are qualified to try your hand at tuning in on London. The material which follows will give you some idea of the problems which may be encountered while searching for signals from "across the pond."

This kind of long-distance reception may appear somewhat fantastic to those acquainted with the 50-150 mile range of the average US TV station. Nevertheless, during the past two winters, there were a number of days when TV transmissions arriving in the midwest from Europe were exceptionally strong. There is every indication that European TV signals of equal excellent intensity will again be encountered next winter.

How and when

We are all accustomed to the world-wide transmission of radio signals on the high-frequency bands extending to approximately 30 mc. Long-range reception on these frequencies is possible because the signal from the transmitter shoots off into space and is reflected to earth by the ionosphere. Depending upon the angle at which the radio wave hits the reflecting ionospheric layer and on the height of this layer, the signal returns to earth a few miles from the transmitter or thousands of miles away. At one time, it was believed that signals above about 30 mc always penetrated the ionosphere and never were reflected. However, in recent years the spectrum above 30 mc has become loaded with amateur and commercial stations and

we have discovered that there are occasions when even signals above 50 mc are reflected by the ionosphere and come back to earth a great distance from the transmitter.

The period of long-range transmission on these frequencies occurs only during years of maximum sunspot activity. Since there were more sunspots in 1957 than at any other time in recorded history, world-wide propagation of signals on frequencies near 50 mc became commonplace. The number of sunspots will decrease during 1958, probably to a level approaching that of 1956. But there were a number of days in 1956 when 50-mc signals were heard around the world, so there is every reason to believe that with proper equipment 45-mc television signals from London will again be receivable in the United States later this year.

European TV comes in best during the fall and early winter months. So, if you wish to attempt to pick up these signals, your equipment should be ready to go not later than the middle of October.

The most important piece of gear for use in hunting TV dx signals is an FM radio receiver which covers 40 to 50 mc. With one of these sets you can monitor this part of the spectrum to check on what stations are coming through, and you can listen in on the sound portions of any video programs which you succeed in viewing. I am lucky enough to own an old Meissner tuner that covers the 40-50-mc band formerly occupied by FM broadcast stations. This unit has picked up TV sound signals from London and Manchester, England; Caen, France and Berlin, East Germany. The raspy notes of the London and Berlin video carriers have also been successfully picked up.

A number of FM receivers that tune from 30 to 50 mc are presently being marketed. Among these are Monitoradio's model PR-31 Police Alarm, the Hallicrafters Civic Patrol type S-94 and the Gonset model 3155 vhf communications receiver. Although the French and English sound transmissions are amplitude-modulated, they can be received on FM equipment by tuning slightly off to one side of the signal.

TABLE I—EUROPEAN TV STATIONS MOST LIKELY TO BE RECEIVED IN US*

Location	Video Freq (mc)	Video Power (kw)	Audio Freq (mc)	Audio Power (kw)
Belfast, Northern Ireland	45.00	12	41.50*	3
London, England	45.00	200	41.50*	50
Caen, France	52.40	80	41.25*	20

A list of all foreign FM and TV stations may be obtained from Superintendent of Documents, Government Printing Office, Washington 25, D. C. Ask for *Broadcasting Stations of the World, Part IV* and enclose 75¢ in coins. *Sound is AM.

TABLE II—COMPARISON OF WORLD'S TELEVISION SYSTEMS

	British	US	Int'l Radio Consultative Committee	Russian	French
Number of lines per picture	405	525	625	625	819
Video bandwidth (in mc)	3	4	5	6	10.4
Channel width (in mc)	5	6	7	8	14
Line frequency (horizontal) (in cycles per second)	10,125	15,750	15,625	15,625	20,475
Field frequency (vertical) (in cycles per second)	50	60	50	50	50
Picture frequency (cycles)	25	30	25	25	25
Sense of video modulation	Pos	Neg	Neg	Neg	Pos
Sound modulation	AM	FM	FM	FM	AM

The French sound comes through quite regularly on 41.25 mc, but the accompanying video at 52.4 mc is so high in the spectrum that there is little chance of receiving it except on extremely rare occasions this coming winter. The European video carriers most likely to be picked up in the US are those from London and Belfast. Since London has an effective radiated power of 200,000 watts, and Belfast 12,000 watts, it is easy to see why the London transmissions are the most consistent, and usually the strongest. Consequently, if you decide to try your hand at TV dxing, I suggest that you center your efforts in the direction of Britain. Table I lists the vital statistics of the dx stations you are most likely to encounter.

By studying Table II, you will note a number of differences between the British 405-line system and our own 525-line standard. The first important dissimilarity is in the spacing between the sound and video carriers. This disparity means that, if you want to hear the audio, along with the picture, you must have a separate sound receiver.

Modifying the sweep circuits

The horizontal frequencies of the two systems differ markedly. I doubt if any factory-built American TV set is equipped with a horizontal control that can shift the oscillator from the normal frequency of 15,750 cycles to the British frequency of 10,125. This means that you'll have to dig into your TV set a bit and make a few modifications. Two popular horizontal oscillator circuits are shown in Fig. 1. If your set uses a multivibrator (Fig. 1-a), you can add capacitance across the ringing coil to lower the frequency. In my receiver, I had to add a .01- μ f capacitor at this point. As this change caused the oscillator to operate somewhat erratically, I also added a 470- μ f mica capacitor in parallel with the coupling capacitor between the multivibrator triodes.

An oscilloscope and a calibrated audio oscillator will help you set the horizontal oscillator to the required frequency. Tune the audio oscillator to 10,125 cycles. Connect its output to the scope's horizontal input. Then, connect the vertical amplifier of the scope between point A and ground. When the multivibrator is running at 10,125 cycles, the pattern on the scope will appear as a slightly warped circle. By trying different capacitances across the ringing coil and adjusting the slug in this coil, you should finally arrive at a point where the receiver's horizontal oscillator is working at the British standard.

If your set has a blocking oscillator circuit (Fig. 1-b), a mica capacitor may be wired in parallel with the grid coupling capacitor to lower the horizontal frequency. A value somewhere between 200 and 500 μ f will probably do the job.

The 50-cycle British vertical frequency is close enough to the American standard of 60 cycles to let the vertical

Map of Australia.
Received at 0930
hours, Jan. 14, 1958.

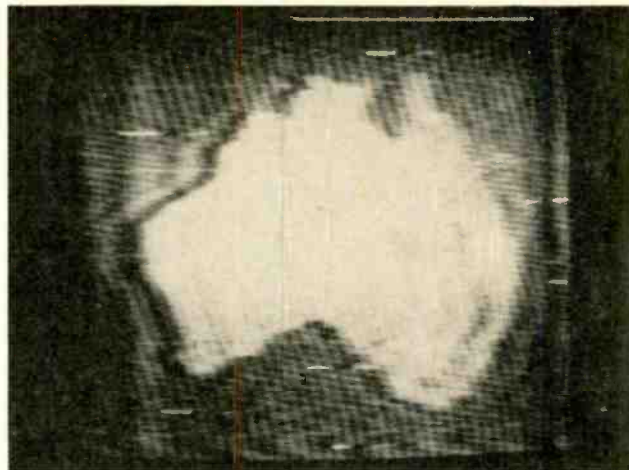

Violinist. Received at
1055 hours Dec. 29,
1957.

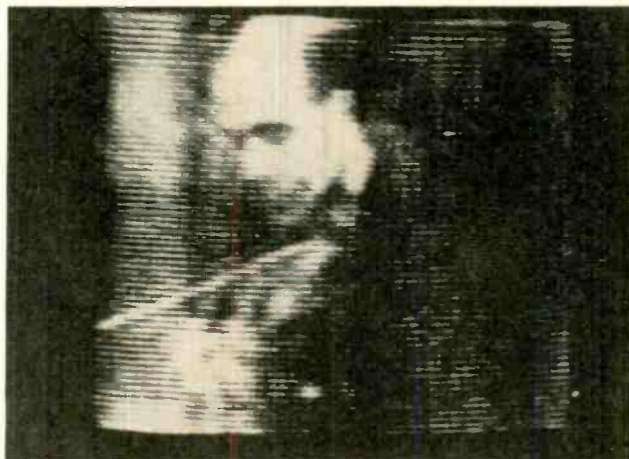

An oscilloscope and a calibrated audio oscillator will help you set the horizontal oscillator to the required frequency. Tune the audio oscillator to 10,125 cycles. Connect its output to the scope's horizontal input. Then, connect the vertical amplifier of the scope between point A and ground. When the multivibrator is running at 10,125 cycles, the pattern on the scope will appear as a slightly warped circle. By trying different capacitances across the ringing coil and adjusting the slug in this coil, you should finally arrive at a point where the receiver's horizontal oscillator is working at the British standard.

If your set has a blocking oscillator circuit (Fig. 1-b), a mica capacitor may be wired in parallel with the grid coupling capacitor to lower the horizontal frequency. A value somewhere between 200 and 500 μ f will probably do the job.

The 50-cycle British vertical frequency is close enough to the American standard of 60 cycles to let the vertical

BBC test pattern.
Note the multiple
ghosts.

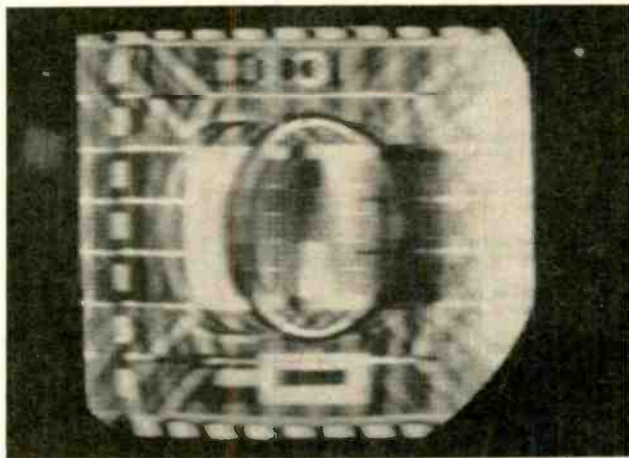

Woman discussing
coughs and colds. Re-
ceived at 0945 hours,
Jan. 14, 1958.



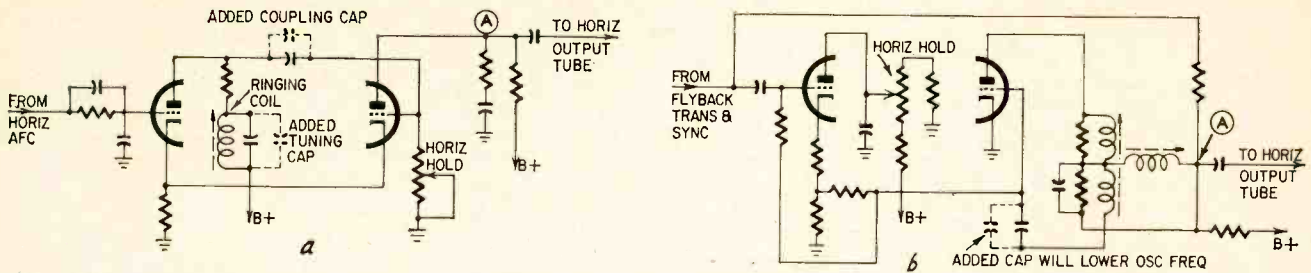

Fig. 1—Adding capacitors is the simple step that changes sweep frequencies to match European standards: a—horizontal multivibrator; b—blocking oscillator.

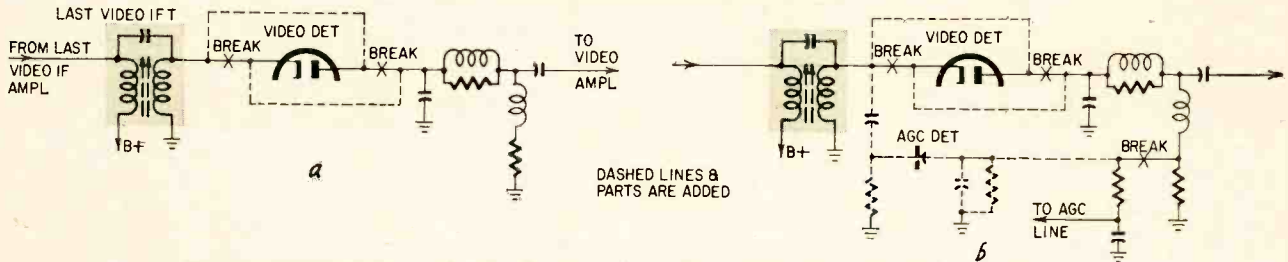

Fig. 2—Switching to positive video modulation: a—set without age; b—set with age.

hold control on your receiver take care of either system.

The American *sense* of video modulation is negative. This means that in this country, as the strength of the carrier increases, the picture gets blacker on the face of the picture tube. English TV stations use positive video modulation and the picture gets whiter as the strength of the video carrier increases. Because of its opposite polarity, the white part of a British picture will appear black on an American receiver. This results in a negative image when a BBC signal is fed to one of our unmodified domestic receivers.

Luckily, there is a very simple way out of this rather strange situation. All you have to do is to reverse the cathode and plate connections of the video de-

tector as shown in Fig. 2-a. Fig. 2-b shows the hookup to use if your receiver derives age voltage from the video detector. Typical constants for the age network can be found by studying similar circuits used in sets made around 1951 and 1952. However, if your set has dc coupling between the detector and first video amplifier, it cannot be used without making extensive changes. This change is needed only to tune in British and French stations. Other European countries use the familiar *negative* video modulation.

Frequency conversion

The European stations you want to see operate on channels not covered by American TV receivers and frequency conversion must be used ahead of your

set. The circuit shown in Fig. 3 is that of an old converter which I happened to have on hand. It was readily adapted to the 40-50-mc range by changing the coils. Since it lacked adequate sensitivity, I added a 6AG5 preselector (see Fig. 4).

Channel 5 (76-82 mc) is vacant in the Detroit area and was chosen as the output frequency of the converter. When tuned to the 45-mc English video frequency, the converter oscillator can be operated either on 33 or 123 mc to produce an output frequency in the middle of channel 5. Because of the vestigial-sideband nature of the London transmissions, the received signal most nearly fits the video response curve of an American receiver if the oscillator frequency is 123 mc. However, results seem to be just about as good when working with an oscillator frequency of 33 mc and, since this frequency is easily measured with the gear available to the average experimenter, the oscillator coil shown is designed for 33 mc.

What kind of antenna

Although it is true that the better the antenna the better the results, I had surprisingly good luck with rather simple aerials. I used a two-element beam in the attic for video reception. It was fastened between the rafters about 18 feet above ground. The antenna proper was a folded dipole cut from 300-ohm ribbon line. Behind it was a length of No. 18 wire which acted as a parasitic reflector. Dimensions are shown in Fig. 5. My sound antenna was a 300-ohm folded dipole without a reflector. Undoubtedly, performance would have been better if the antennas had been made of aluminum tubing and mounted high in the air, clear of surrounding objects. However, it was late fall when I started my experiments, and I like to do my skywire work when the weather is warm. It is worth noting that, even though the 45-mc transmissions are vertically

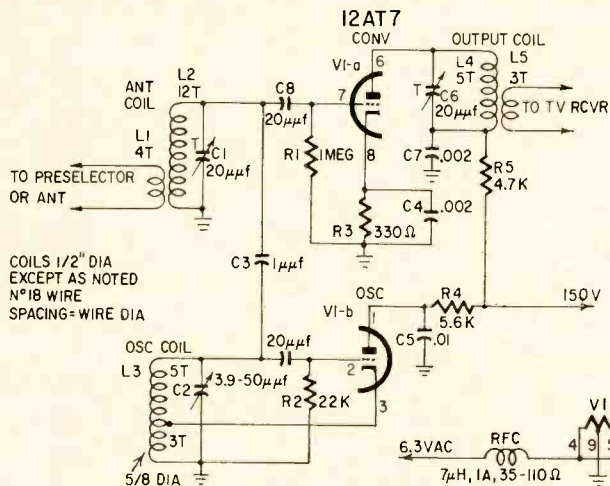

- R1—1 megohm
- R2—22,000 ohms
- R3—330 ohms
- R4—5,600 ohms
- R5—4,700 ohms
- All resistors 1/2 watt 10%
- C1, 6—20 μmf mica trimmer
- C2—3.9-50 μmf, variable (Hammarlund APC-50 or equivalent)
- C3—1 μmf
- C4, 7—.002 μf
- C5—.01 μf
- C8, 9—20 μmf
- L1—4 turns, coupled to grounded end of L2, 1/8-inch

- spacing
- L2—12 turns
- L3—8 turns, 5/8-inch-diameter coil, tapped at 3rd turn
- L4—5 turns, wound on 1/2-inch polystyrene coil form with L5, 1/8-inch spacing between coils, L5 at B-plus end of L4
- L5—3 turns
- All coils 1/2-inch diameter, self-supporting unless noted. Wound with No. 18 wire.
- Turns spaced diameter of wire.
- RFC—7 μh, 1,000 ma, 35-110 ohms (Ohmite Z-50 or equivalent)
- VI—12AT7
- Sockets, terminal strips, miscellaneous hardware.

Fig. 3—Simple converter puts BBC on channel 5. Oscillator grid capacitor is C9.

polarized, the receiving antenna can be mounted in a horizontal plane because the original polarization of the signal is lost as it passes through the ionosphere.

The best time of day to look for foreign TV signals is from around 0800-1300 EST. An all-daylight path is usually required between the transmitter and the receiver. Due to uncertain propagation conditions on the very

the signals arriving at the receiver will travel several different paths. These paths are usually not of equal length, and numerous ghosts may appear on the screen, just as when you have multipath reflections on local TV signals. This ghost problem is often acute. Once, in a tennis match from overseas, there were at least 30 players batting 15 balls back and forth. The sync pulses, as well as picture elements, are subject to this ghosting effect. Consequently, there are often so many sync pulses of varying phase and amplitude that the receiver's circuits are unable to cope with them. At these times the picture jumps wildly up and down and sideways. Fairly often, however, ionospheric conditions settle down and a single, steady picture appears on the screen. Large objects, human faces and sometimes even program titles are then recognizable.

NEXT MONTH

READY FOR STEREO?

High-Fidelity author Don Hoefler tells newcomers to the stereo art what to do and what is needed to enjoy the latest development in the field of good music listening.

NEW COLOR TV CIRCUITS

Bob Middleton describes some circuits that differ in many respects from those we learned about when we were trying to master color TV.

USING THE NE-77 NEON TRIODE

This new low-priced 3-electrode neon lamp will do many things that could formerly have been achieved only with expensive thyratrons. Tommy Tyler tells how to use it.

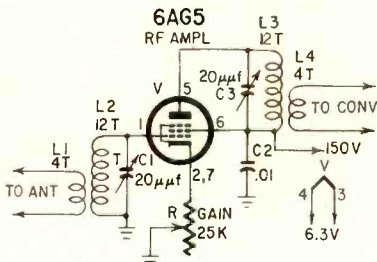

COILS 1/2" DIA, N° 18 WIRE, SPACING=WIRE DIA

- R—pot, 25,000 ohms
- C1, 3—20 μ f, mica trimmer
- C2—0.01 μ f
- L1—4 turns, wound over cold end of L2, layer of electrical tape between coils
- L2—12 turns
- L3—12 turns
- L4—4 turns, wound over cold end of L3, layer of electrical tape between coils
- All coils wound on 1/2-inch diameter forms with No. 18 wire. Turns spaced diameter of wire.
- V—6AG5
- Sockets, terminal strips, miscellaneous hardware

Fig. 4—For more gain, use this preselector ahead of the converter shown in Fig. 3.

high frequencies, it is difficult to say on what date long-distance reception will again be possible. I would suggest, though, that you be prepared to listen and watch not later than Oct. 15, 1958. Once you pick up programs in French at 41.25 and English at 41.5 mc on your sound receiver, you can be sure that conditions are optimizing. Keep checking 45 mc for the raspy buzz produced by the London video carrier. As soon as it comes through, you can try for a picture on the TV set.

Tuning in for dx

Set the receiver's fine tuning at mid-range on channel 5, or 6 if 5 is occupied in your locality. Tune the converter oscillator back and forth until the familiar out-of-sync zig-zag lines denoting a video carrier appear on the screen. The vertical hold control should stop the picture vertically, but you may have to readjust the horizontal oscillator transformer or ringing coil slug a bit before the horizontal hold control will bring the picture to a standstill horizontally. All the tuned circuits in the converter may now be adjusted to give you the sharpest image. You get the greatest contrast when all signal circuits are tuned to the same frequency. This arrangement, however, will result in a peaked response with low picture definition. Stagger tuning will reduce the gain, but will make for a better picture. TV dx tuning is an art that is a little hard to describe on paper. It is best learned by experiment.

Don't expect the pictures to be as sharp and steady as the ones you get from your local TV station. Since the ionosphere is a very imperfect reflector,

There are several explanations for the lack of sharpness in the image produced by a foreign TV signal. A certain amount of smearing appears because the if curve of an American receiver is not absolutely compatible with the signal transmitted from overseas. Ghost effects also tend to reduce the apparent sharpness. The selectivity introduced by the converter ahead of the TV re-

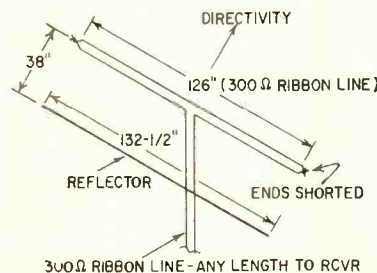

Fig. 5—Sketch of beam antenna for 45-mc TV reception.

ceiver also contributes to loss of definition. Probably most important, however, is the fact that because of varying ionospheric conditions, it is seldom possible to receive all portions of the TV channel with equal strength. Another cause of picture degradation is the TVI produced by the many American mobile services operating between 40 and 50 mc.

When you get pictures on your TV screen direct from London, you'll undoubtedly want to photograph them to have a permanent record of your efforts. I used a 35-mm camera loaded with Plus-X film for the illustrations accompanying this article. Exposure was f 4.5 at 1/25 second. This shutter speed is optimum, as it is roughly equivalent to the scanning time required for one complete frame. [For more details on this type of photography, see "Photographing C-R Tube Images," RADIO-ELECTRONICS, February, 1958.]

Don't be surprised if the photos lack the sharpness and detail of the image you thought you saw on the TV screen. Remember, a camera lacks the human brain's ability to fill in the small details which it knows should be in a picture, even when they aren't. END

Part II—Modern
uhf tuners for
today's TV set

NEW in TV TUNERS CIRCUITS

By E. D. LUCAS, JR.

LAST month we examined the standard and Fireball models of the Neutrode vhf tuner. Now we will see a uhf unit that fits piggyback on the standard neutrode model, and a miniature uhf tuner designed for current TV receivers.

Piggyback uhf tuner

Two principal approaches to the problem of tuning in uhf channels are used by Standard Coil designers. One is to install a type N4A uhf strip in place of any unused vhf channel's oscillator coil, and then to provide a separate uhf antenna input assembly. The second approach, preferred whenever several uhf as well as vhf channels are to be received or when the best uhf reception is desired, is to use the tiny Standard piggyback all-channel uhf tuner, illustrated in Fig. 5. This unit plugs into ND tuners of either the drum-turret or Fireball types, provided that these vhf tuners are equipped with a 13-position turret instead of the 12-position turret used in vhf-only receivers. That is, the ND tuners are made in both 12-position and 13-position versions, with the 13th position switching off the vhf oscillator and furnishing a path for the if signal output from the uhf tuner to the rf amplifier and mixer of the vhf tuner, which act as amplifiers for the if signal with the vhf oscillator cut off.

Looking at Fig. 6, the circuit of the piggyback uhf tuner, we see that the input from the 300-ohm antenna lead is inductively coupled by L23 to the two preselector lines indicated as L18 and L19. These are quarter-wave coaxial lines tuned by end capacitances varied

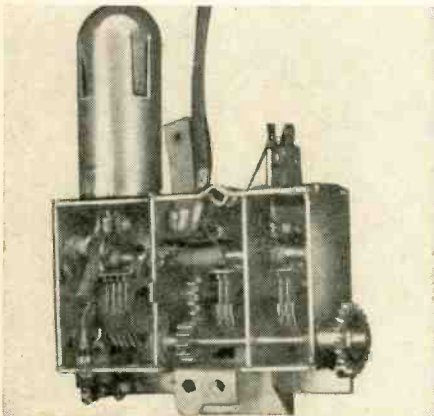

Fig. 5 — Piggyback all-channel uhf tuner.

by the tuning shaft's position. This input signal is heterodyned at the crystal mixer 1N82-A with an oscillator signal from the 6AF4-A oscillator circuit. This is a grounded-plate tuned-grid modified Colpitts oscillator. Note that the same tuning control that varies the end capacitance of the two preselector lines also varies the tuning capacitor in the oscillator grid circuit.

The if signal obtained at the 1N82-A mixer appears across inductances L24 and L16 which, with capacitor C20, form a circuit resonant at the 41-mc if frequency (actually 41.25 mc for sound). This if output is then fed through a coaxial cable to the 13th position of a vhf ND tuner, where it is amplified by the Neutrode vhf amplifier and the pentode mixer, as previously mentioned.

The piggyback uhf tuner is 3.60 inches long, 2.312 inches high (not including oscillator tube and shield) and 1.157 inches wide. Power requirements are 75 volts at 16 ma and 6.3 volts for parallel heater circuits, 600 ma for series heaters. Noise factor is 17 db maximum when measured through the ND-4000 vhf tuner (turret of the drum type). Image rejection is 30 db minimum. Oscillator drift is less than 750 kc during a period of from 3 to 30 minutes of warmup, allowing for a temperature rise of 25°C.

Fig. 7 shows how the piggyback uhf tuner connects to the ND vhf tuner, utilizing what is called a channel-1 strip in the 13th position of the tuner.

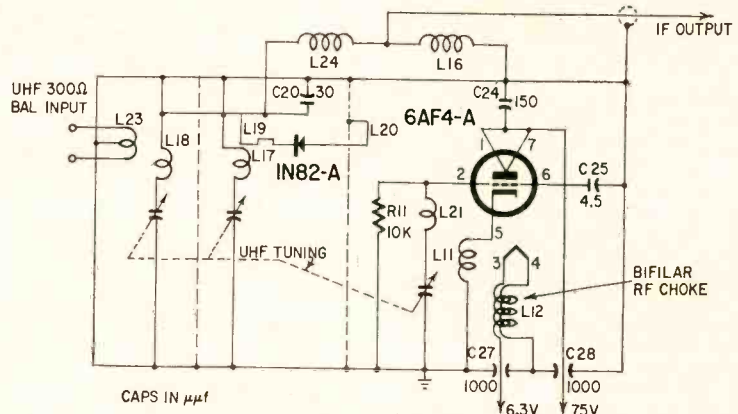

46 and 50 db. Thus there is ample gain in these two stages to boost the weak uhf signal at the intermediate frequency, to about the same level as the if output of the vhf tuner, so that either signal enters the first if amplifier stage at approximately the same level.

Referring to Fig. 7 again, note that in this position the vhf antenna input is shorted to ground. This is very important, so that no interfering signals in the 41- to 46-mc range come in to "hash up" the desired if signal from the uhf tuner. Also the 135-volt B-plus is fed to the uhf tuner (requiring only 70 volts) through a dropping resistor.

The alternate method for uhf reception in Standard Coil tuners consists of a special coil board for each uhf channel desired. Obviously this technique is practical only where the total number of desired vhf and uhf channels does not exceed 12. In a uhf coil board, the oscillator consists of a crystal acting as a harmonic generator to produce the desired harmonic of the oscillator in the vhf tuner, such as the third or fifth harmonic. This signal is heterodyned with the received uhf signal in a 1N82-A mixer to produce an if signal which again is amplified in two stages in the vhf tuner.

General Instrument model 204

Even smaller in size and excellent in performance is another all-channel uhf tuner, the model 204 developed by General Instrument Corporation's F. W. Sickles Division. This unit, shown in Fig. 8, is 2.69 inches square by 1.375 inches deep and weighs a mere 13 ounces. Its square-shaped construction is held to be a factor in improved stability and ease of mounting, helping to keep the tuner on the desired station even if the receiver is moved or jiggled. Numerous mounting holes and provisions for adding a variety of tuner drive mechanisms contribute to the versatility of this uhf midget. Most important feature of the design, however, is that it can be produced at low cost compared to previous all-channel models and hence has marked appeal for set makers who want to offer improved uhf reception at a reasonable price.

When we look at the circuit in Fig. 9, we can see how closely the circuit design of the model 204 parallels that of the piggyback uhf tuner. Again we find a 6AF4-A oscillator tube (or its series equivalent) and a crystal diode type (1N82-A or equivalent) mixer-converter producing an if signal output. Evidently, this is again a single superheterodyne receiver with no rf amplification ahead of the mixer, and with a variable capacitor assembly used for tuning.

According to General Instrument engineers, they decided that the most profitable area in which to concentrate design efforts was improving the design of the preselector and oscillator coaxial lines which, with the variable capacitors, form the basic tuning elements.

Looking at Fig. 9, we see two pre-

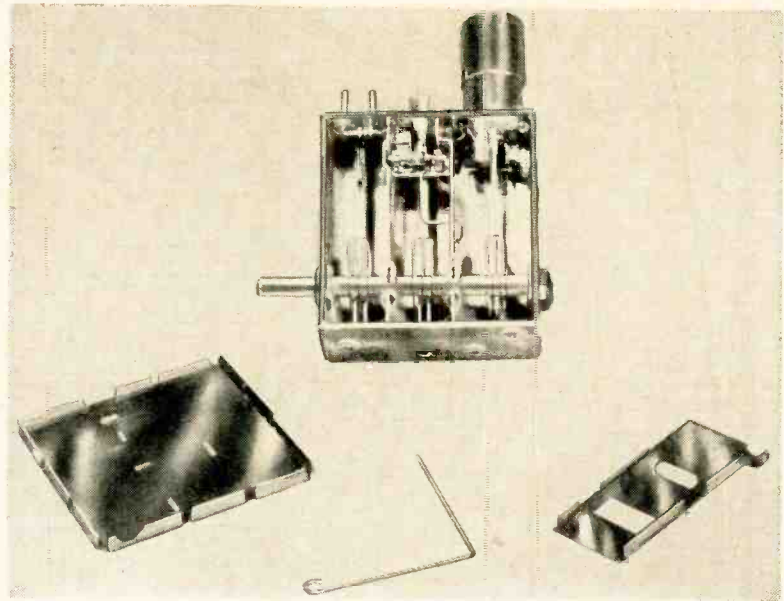

Fig. 8—General Instrument's model 204 uhf tuner.

selectors, each a quarter-wave coaxial line tuned by an end capacitance. Two preselectors assure sufficient skirt selectivity. A single one would mean lower insertion loss and hence a better noise figure, but image-rejection specifications of 40 db minimum require two preselectors to function efficiently at the bandwidths and if frequencies specified. Another important consideration, in addition to image rejection, is that the two are needed to guarantee adequate blocking of the local oscillator frequency, which is about 43.5 mc (picture) above the signal frequency. Without this blocking, oscillator radiation at the antenna terminals would exceed the limits set by the FCC.

In designing a preselector circuit, the loaded Q of the circuit is governed by skirt selectivity—that is, image-rejection and oscillator-radiation specifications. Since the insertion loss of a preselector varies inversely as the unloaded-to-loaded Q ratio, a high unloaded Q is undesirable. Loaded Q's in uhf tuner preselectors are typically from 25 to 50. To keep insertion loss below 0.5 db per preselector requires an unloaded-to-loaded Q ratio of 20.

Thus unloaded Q's should range from 500 to 1,000. The unloaded Q depends on the impedance of the coaxial line and the length of that line, while impedance depends on the dimensional relationship between inner and outer conductors.

Another design criterion for these uhf preselector lines is the ability to tune over the entire frequency range from 470 to 890 mc with a small set of capacitor plates. Again the amount of tuning capacitance required becomes a function of the impedance and length of the coaxial line. In the model 204, the length of the two preselector lines has been reduced from 3 inches each—a typical figure for earlier tuners—to only 2-7/16 inches. One result has been reduced size and spacing of capacitor plates. This permits notably smaller overall tuner size as well as greater efficiency. In addition to reducing preselector line length, the designers of this new tuner have chosen cross-section dimensions to achieve a line impedance close to the optimum Q while maintaining sufficient tuning bandwidth.

Other factors in preselector design are correct setting of the loadings at

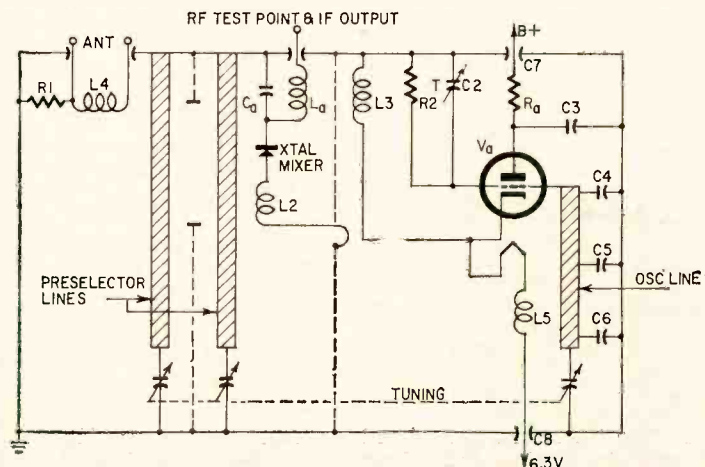

Fig. 9—Circuit of the model 204 all-channel uhf tuner.

antenna and mixer, as well as the coupling between these two circuits. These adjustments are made so that there is a slight overcoupling at the extremes of the uhf range and critical coupling at midband. Loadings are set by careful design of the shapes, and correct location, of the antenna and mixer coupling loops in the coax lines.

A second major factor in improved uhf tuner design demonstrated in the model 204 is a better oscillator circuit. Basically, this is a ground-plate tuned-grid modified Colpitts oscillator which must meet four principal criteria:

1. Sufficient output to drive the mixer crystal at an efficient level.
2. Power output low enough to avoid excessive radiation.
3. Low thermal drift.
4. Essentially linear frequency calibration.

There must be a compromise to satisfy the first two requirements. In the model 204, these requirements are met by an oscillator circuit that operates satisfactorily with a B-plus as low as 40 volts, assuring a low radiation figure.

The third design problem, keeping thermal drift low, can also be solved only by compromise. Adding drift-compensating capacitors lowers the maximum frequency obtainable with a given impedance. Modifying the impedance to permit adding capacitance results in decreased oscillator efficiency. A further handicap is that in miniature tuners, because of their construction, there is a greater amount of minimum capacitance than in larger tuners. Hence, full drift compensation has heretofore been possible only with these bigger tuners. But the importance of proper compensation has been greatly increased with the advent of color TV since a relatively slight change in frequency causes loss of color in the picture. With the compensation provided by the designers of the model 204, this tuner has a maximum drift of about 200-300 kc. This advance in oscillator stability should make the tuner popular with users as well as receiver manufacturers and service technicians.

To achieve linearity, it is necessary to eliminate, detune or decouple each possible absorbing element; to reduce ground currents to a minimum, and to maintain oscillator activity at a uniform level throughout the uhf band. General Instrument designers state that they have been successful in eliminating the resonances and nodal points typical of uhf oscillators, thus getting rid of the dead spots which make necessary unduly high output at some frequencies to compensate for these low activity points.

By a combination of electromechanical improvements in the design of the two preselector lines and the oscillator circuit, engineers responsible for the model 204 have vastly reduced the size of this uhf tuner and have also achieved real advances in performance, both electronic and mechanical. **END**

TRANSMISSION-LINE MATCHING

By HENRY A. KAMPF

Resistance match three or more lines to one antenna

CONNECTING three or more transmission lines poses the problem of proper impedance matching to minimize standing waves in the system. Ideally, lines would be matched with rf impedance-matching transformers which do not dissipate energy. Therefore the rf power would be equally divided among all of the lines.

Lines can also be matched properly with ordinary 1/2-watt carbon resistors,

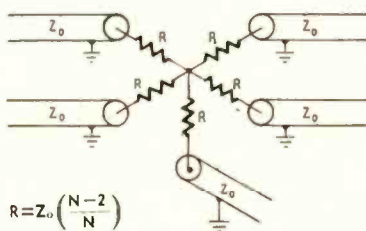

Number of Lines(N)	VALUES OF R					Db Loss = 20 x log(N-1)
	Characteristic Impedance (Ohms)					
	50	73	150	300	375	
2	0	0	0	0	0	0
3	17	24	50	100	125	6.02
4	25	37	75	150	188	9.54
5	30	44	90	180	225	12.04
6	33	49	100	200	250	13.98
7	36	52	107	214	268	15.56
8	38	55	112	225	282	16.90
9	39	57	117	234	292	18.06
10	40	58	120	240	300	19.08

Fig. 1—Series connecting coaxial lines. All lines have a common ground.

if the lines all have the same characteristic impedance and if the power lost in the resistors does not reduce the signal below a usable level. This condition occurs in strong-signal areas where several receivers are connected to a common antenna. Any mismatch can cause standing waves which appear as ghosts on the TV screen. In such areas reduction in signal strength is not important but the match of the rf lines is quite critical. Similar situations occur with test equipment and occasionally in amateur applications.

When matching with resistors, two connections are possible. The series resistor connection is used for lines having a common ground, such as coaxial

cables. The shunt resistor connection can be used with balanced lines. Figs. 1 and 2 show how the matching networks are connected and give the formulas for calculating the necessary resistor values. The symbols used in the equations are: Z_0 —characteristic impedance of the transmission lines used; N —total number of lines that are joined; R —resistor value required in the diagrams.

When one of these lines is a signal source, the loss of the network for this signal down to any one of the other lines is calculated from the equation $L = 20 \log(N - 1)$, where L is the loss in db. This equation is the same for either the series or shunt connection. In the examples of Figs. 1 and 2 five lines are joined; therefore, N is 5. If 300-ohm transmission lines are used, Z_0 is 300. Substituting these values into the equations we find that the required resistance R is 180 ohms for the series connection and 500 ohms for the shunt connection. The signal strength appearing on any one of the lines will be 12.04 db down from the signal applied to any one of the other lines. **END**

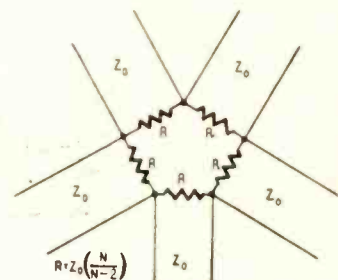

Number of Lines(N)	VALUES OF R					Db Loss = 20 x log(N-1)
	Characteristic Impedance (Ohms)					
	50	73	150	300	375	
2	∞	∞	∞	∞	∞	0
3	150	219	450	900	1125	6.02
4	100	146	300	600	750	9.54
5	83	122	250	500	625	12.04
6	75	110	225	450	562	13.98
7	70	102	210	420	515	15.56
8	67	97	200	400	500	16.90
9	64	94	193	386	482	18.06
10	63	91	188	375	469	19.08

Fig. 2—Shunt connecting two-lead lines.

TELEVISION

tube, you will require a new yoke and flyback. A larger vertical output transformer is also necessary. We suggest that you obtain a standard 90° conversion kit. Some mechanical changes, of course, are also required to accommodate the larger tube.

More on the KCS-47

I note R. W.'s trouble (February, 1958) with an RCA KCS-47, and would like to pass along some further data:

"The vertical output transformer winding is bypassed by two .047- μ f 1,000-volt capacitors (see Fig. 4). They bypass each side to ground and are

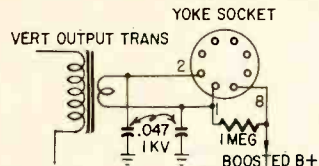

Fig. 4—Failure of bypass capacitors can cause yoke breakdown.

located behind the yoke plug socket. I have seen many of them short to ground. This places B-plus boost voltage between the horizontal and vertical windings."—L. P., College Park, Md.

Tuner doesn't work right

A Standard Coil tuner model 5001 does not operate properly in a Muntz 37A4, although both have 21-mc circuits. The slugs fall out before a satisfactory adjustment can be made. Capacitor adjustment in the oscillator section does not bring the tuner into range.—T. E. C., Cedartown, Ga.

When the tuner was installed, the alignment of the first if stage was undoubtedly changed. The set's if passband must match the tuner's output passband. Use a good sweep and marker generator and scope to check the response. It is also advisable to make an rf alignment of the tuner. This will undoubtedly solve your difficulty.

Boost brightness

How can I increase screen brightness without using higher voltage or getting more scanning width? — J. W. L., Wayne, W. Va.

Your letter does not state the operating value of high voltage which you now have. Sometimes, it is possible to use an aluminized picture tube to get more brightness and contrast than with a nonaluminized tube. However, you must have working voltage for the aluminized tube that you use. Less than rated voltage will prevent the aluminized tube from giving any advantage.

Audio interference

A Sylvania 21C501 developed AM audio interference on channel 8, but not on channel 3. The channel 8 station is 50 miles distant. New tubes and a line filter have not helped. The interference can be eliminated by detuning the fine-tuning control, but this deteriorates picture quality. Could an oscillating AM receiver in the neighborhood cause

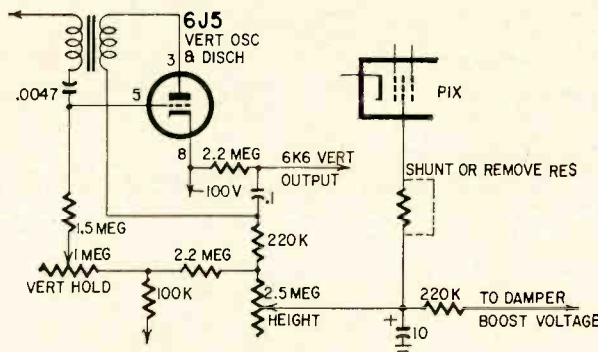

Fig. 5—Circuit to prevent spot formation.

this trouble? — A. L. G., Manila, P. I.

If no new high-powered AM station has been put into operation in your vicinity, I would expect that a reradiating AM receiver is responsible for the interference. Cross-modulation can cause interference when the AM field strength is high. A good TV high-pass filter in the lead-in might kill the interference. A new AM station could also radiate enough harmonic energy, possibly, to interfere with a TV transmission 50 miles distant. This can only be eliminated by using a narrow-beam antenna. Such an antenna may also help in eliminating interference from reradiating AM receivers.

Kill that spot

Several years ago I assembled a TV receiver kit which works well, except that a bright spot remains after switching the set off, and eventually burns the screen of the picture tube. What can I do? — R. F. C., Los Angeles, Calif.

You should use a spot killer, as described in *Television Technotes*, published by the Gernsback Library. Since you do not mention the model of your kit receiver, I cannot make specific suggestions, but will repeat the advice published in the book:

Spot killer

"This circuit modification prevents formation of the intense spot of light that appears in the center of many TV screens immediately after the set is turned off. In most TV sets the picture tube first anode is supplied from some point in the power supply proper. Fig. 5 shows how a popular RCA circuit can be modified so that the first anode is supplied directly from the arm of the height control which usually obtains its voltage from the damper-boost circuit. If the original circuit has a resistor

in series with the first anode, remove it.

"This circuit also aids in eliminating the brown spot seen on kinescope screens after some use. Although the circuit shown is applied to the 630-type set, there is no reason why it cannot be applied in other receivers.

"Take care when adding this circuit to sets having large picture tubes, because the boosted voltage may exceed the maximum voltage which may be applied to grid 2. If the voltage exceeds 400, use a voltage divider."

17- to 21-inch conversion

Can a Motorola TS-118 using a 17AP4 be converted for a 21-inch tube? — W. J. H., Astoria, N. Y.

The best choice of a 21-inch tube will be a 21EP4. This tube is comparatively easy to sweep, and it is likely that no electrical changes will be required. However, if some nonlinearity occurs, the yoke can be changed.

Kinks in the raster

I built a 10-inch TV kit which has two kinks in the raster about 3 inches apart. Both kinks are affected by the vertical-hold control. The vertical oscillator (Fig. 6) uses a 6C4 and a scope at the grid or plate shows a crawl in the waveform. I cut the vertical oscillator out of the circuit and used a separate power supply, with no improvement. — D. W. T., Longview, Tex.

Your first check was well directed. It shows that the spurious voltage is not entering through the height control, but is coming in through the integrator. Continue your scope checks step by step back from the integrator, to see where this spurious voltage first enters the circuit. A low-capacitance probe can be used back as far as the picture detector. A demodulator probe must be used in the if strip.

END

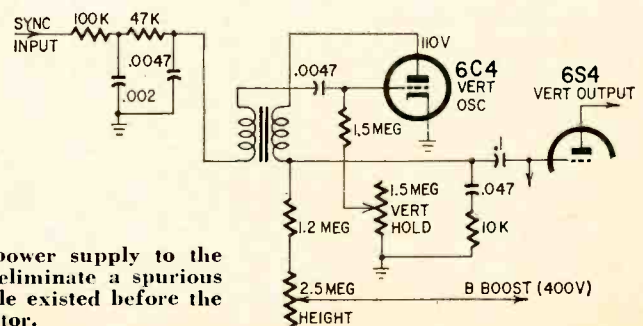
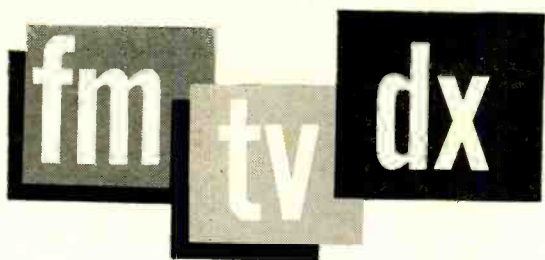

Fig. 6 — A separate power supply to the height control did not eliminate a spurious voltage, when the trouble existed before the integrator.



By ROBERT B. COOPER, JR.

In our June column, we discussed briefly how to count a logging of a station if it should change channels, increase power, move transmitter location, etc. This section was designed to clarify the statistics problem, bringing every dxer to an even operating plane.

From comments received, the suggested standards have met with fairly universal acceptance, although some dxers did lose a "station or two" in their totals tabulation. In a future column, we will have more to say about standards for the nationwide-minded dxers, as opposed to the isolationists. Meanwhile, we suggest that you go over your own totals and get them ready to mail to the TV Dx column before Oct. 15.

Send along your latest complete station total, uhf station total and best distance on each of the three bands (channels 2-6, 7-13 and 14-83). This information will be used in preparing the January, 1959, listing of all dxers with over 50 stations to their credit.

Trops bending session

For several years, the last week of May has produced at least one widespread ground-wave dx opening throughout the Midwest and Great Lakes area. At the height of these sessions, distances of 500-700 miles have been covered frequently on the high-band vhf channels (7-13).

This year produced a similar session, although it was not nearly as evident as in past years. Noted as early as 1930 hours on June 3 by Walter Owens, Jr. of Springfield, Ohio, who logged KCRG-TV, channel 9, Cedar Rapids, Iowa (490 miles), the last reported logging of this trop session was on the morning of the June 6 when Clark Conway of Knightstown, Ind., logged WTRF-TV, channel 7, Wheeling, W. Va., some 450 miles. Many similar loggings (400-600 miles, high band) are reported by dxers David Novick, of Shorewood, Wis., and Albertus Hoogveen, of Lansing, Ill.

Other than the two Mexican stations located on the Mexico-California border, Western US dxers seldom, if ever, see television stations from our nearest neighbor to the south. However, on May 25, reception from Calexico (border station), Monterrey and Mexico City stations (double hop) was reported throughout the West. Seen in Boise, Idaho, as early as 1730 PST by Ed

Brawley and as late as 1930 by Ron Pugh, Fort Bragg, Calif., stations XEW-TV, channel 2, XEZ-TV channel 3; XHGC-TV, channel 5; XHNL-TV, channel 2; XEM-TV, channel 3 were reported in varying degrees in many dxing locations.

FM dx

One of the first FM skip openings to come to our attention since the inception of this portion of the vhf dxing column, occurred on the evening of June 19, between the Middle Atlantic and Midwestern states. M. Harvey Gernsback of Plainfield, N.J., reports reception from WOI, Ames, Iowa, on 90.1 mc, and tentative reception of KANB, Lawrence, Kans., on 91.3 mc. Three stations, operating on 88, 90.3 and 91.9 mc, also skipping in with the same program material, were believed to be part of the Wisconsin State Educational net.

Bernard S. Gurman of Malden, Mass., notes a ground-wave haul from WGH, 97.3, Newport News, Va.

Another chap who has had some good luck with FM skip dx is Clifford Violette, of Gardner, Mass. Dyer Violette reports excellent skip reception on the morning of June 20, from WEAU, 94.1 mc, Eau Claire, Wis.; WJMC, 96.3 mc, Rice Lake, Wis.; WHRM, 91.9 mc, Wausau, Wis.; WHWC, 88.3 mc, Colfax, Wis., and WHAD, 90.7 mc, Delafield, Wis., all approximately 1,100 miles distant. Checking the TV band at this same time, he found WKZO-TV, channel 3, Kalamazoo, Mich., and KDAL-TV, channel 3, Duluth, Minn., breaking through the snow barrier.

One of the top FM dxers in the country, Bruce Elving, Duluth, Minn., reports on his totals. In 9 years of FM dxing, Elving has logged 311 stations from 32 states, the District of Columbia and Quebec. His greatest distance loggings include St. Petersburg-Tampa, Fla. His present equipment is a Harman-Kardon Theme tuner, while the antenna consists of double-stacked five-element Yagis on a rotator.

FM and metropolitan dxers

Unlike the television dxer, the FM dx fan can and does survive in crowded metropolitan areas. Even in the most heavily populated areas along the Eastern seaboard, the FM band is filled with "clear spots"—frequencies on which dx stations can sneak through. Using

sharp-patterned Yagi antennas and selective tuners, the vhf dx enthusiast will find that dx reception is much more reliable and easier to work with on the 100 FM channels than on the 12 vhf TV channels (when 7 are occupied by locals!).

DX predictions

After a summer of violent and prolonged displays of E skip, the "fair-weather" dxer will be dismayed to find action dwindling greatly during the next three months. However, dxers in the southern sections of the country will be treated to E-skip openings until mid-September, mostly involving east-west paths in the early evening (and late afternoon) hours.

This September should produce many brilliant auroral displays and, coinciding with the beginning of such visual displays, east-west skip paths across southern Canada and the extreme northern United States should be covered via Es. Such auroral-Es openings are normally mid-evening occurrences accompanied by violent fading of both the audio and video signals.

During the last week of August, TV and FM dxers should notice a marked upturn in ground-wave coverage. A gradual upturn in reception from fringe-area stations is a sign of something special brewing and should provide the incentive necessary to hold the dxer close to his set.

Keep an eye on weather maps in daily papers and on TV weather shows. A large, slowly moving, "high" frontal zone headed into your area is the key to excellent extended ground-wave reception on all TV channels (2-83) and the FM band. Late-evening and early-morning "localized" ground-wave reception will continue to be good over the Central Plains area and throughout the South into October.

The months of September and October can produce a spectacular meteor shower or two, but unfortunately this is not one of the years that they do. Oct. 2 will bring a secondary shower, the Quadrantids, which peaks on basic east-west skip paths from 0900 LST (Local Standard Time) to 2000 LST. Oct. 12-23 is another good period for the burst enthusiast, as the Arietids shower brings good north-south radio-path meteor-burst reception. (North-south depicts a Great Circle path such as Chicago to New Orleans, while east-west describes signal propagation between points such as Kansas City and Baltimore.)

The best hours for the Arietids are from 2130-2330 and 0230-0430 LST. Daxers on both the TV and FM bands would do well to watch these dates and times closely for possible new loggings.

With the coming of fall, F2 skip returns to the Northern Hemisphere. Late October mornings should bring frequent reception of BBC-TV, London, on European channel 1, to those dxers set up to receive British standards and

(Continued on page 78)

"HEATHKITS®

gave me my start and I'm still sold!"

"... they are my lowest cost way to real quality and dependability in electronic equipment of any kind ...

... The clean, modern styling of HEATHKITS make me proud to own them. They make a handsome and useful addition to my workshop.

... Rigid quality standards of components used in HEATHKITS assure me of performance equal to or surpassing instruments costing many times more.

... after assembling a HEATHKIT myself, I know what "makes it tick"... I know that the thoughtful circuitry design and name-brand components used throughout guarantee me years of trouble-free service.

... HEATHKITS cost me half as much as ordinary equipment ... and I get so much more. In assembling my own instruments I am sure of the quality that goes into them. Plus the complete assembly and operating instructions as well as detailed schematics that are at my fingertips for future reference."



NEW: Stereophonic Sound for your home with the new HEATHKIT STEREO CENTER. This, and other exciting new high fidelity developments are now available from the world's largest maker of "do-it-yourself" electronic kits.

NEW: For the Ham Radio fans—an all new Ham Transmitter and companion Receiver—featuring all the latest developments in Ham communication—including single-sideband operation.

NEW: A completely up-to-date Oscilloscope answering the long felt needs of electronic engineers and servicemen everywhere.

NEW: A host of newly developed marine instruments for the safety and convenience of the boat owner.



HEATH COMPANY Benton Harbor 20, Michigan

 subsidiary of Daystrom, Inc.

The HEATH TIME PAYMENT PLAN
allows you to outfit your whole workshop at one time with needed test instruments while you pay in easy monthly installments.

PROFESSIONAL OSCILLOSCOPE KIT

An exciting development in the Heathkit instrument line is the introduction of the Heathkit model OP-1 Professional Oscilloscope. Emphasizing complete flexibility in any application, the OP-1 features DC coupled amplifiers and also DC coupled CRT tube un-blanking. The triggered sweep circuit will operate on either internal or external signals and may be either AC or DC coupled. The polarity of the triggering signal may also be selected, and any point on the wave form may be selected for the start of the sweep by using the "triggering level" control. An automatic position is also provided, in which the sweep recurs at a 50 cycle rate, but can be driven over a wide range of frequencies with no additional adjustments. The sweep frequencies are provided by switch-selected base rates of 2 and .2 milliseconds/CM, and 20, 2, and 1 microseconds/CM, in conjunction with a continuously variable 10 to 1 multiplier. Sweep frequencies are calibrated to within 10% at all control settings, and the sweep frequency may be reduced by adding capacity to the "ext. cap" binding post on the front panel. A 5ADP2 flat face CR tube is used for accurate readings on an edge lighted grid screen. A high quality conetic-fernetic CR tube shield prevents stray AC fields from distorting trace. A 12-position vertical attenuator is calibrated in volts-per-CM and the horizontal sweep is calibrated in time-per-CM. Prewired terminal boards are used for rapid, easy assembly of all critical circuits. Simply install and connect the color coded leads. Power supply is transformer operated utilizing silicon diode rectifiers and is fused for protection. Under development for over a year the OP-1 promises outstanding results in any application requiring the use of an oscilloscope.

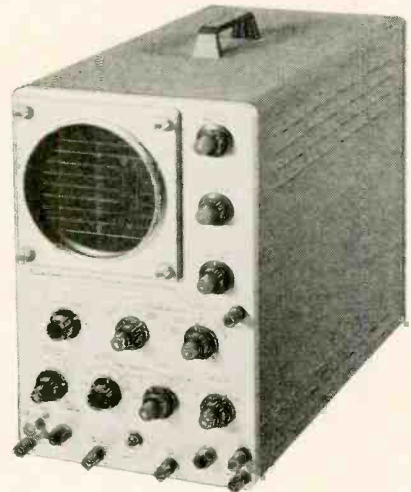

HEATHKIT
OP-1
\$179⁹⁵

*Here's the scope you've
been waiting for!*

AVAILABLE AFTER JUNE 15



**Laboratory
Performance At Less
Than Utility Scope
Price**

HEATHKIT
O-12 **\$64⁹⁵**



**A Scope You Will Be
Proud To Own**

HEATHKIT
OM-3 **\$39⁹⁵**

"EXTRA DUTY" 5" OSCILLOSCOPE KIT

Top quality features at half the cost of ordinary equipment sum up the advantages of this popular kit. Critical observations in your laboratory or shop are handled easily, with clear, sharp pattern displays in every application. Vertical frequency response extends from 3 CPS to 5 mc ± 1.5 db -5 db without extra switching. Response is down only 2.2 db at 3.58 mc. The Heath patented sweep circuit functions effectively from 10 CPS to better than 500 kc in five steps, giving you 5 times the usual sweep obtained in other scopes. An automatic sync circuit with self-limiting cathode follower provides excellent linearity and lock-in characteristics. Extremely short retrace time and efficient blanking action. Both vertical and horizontal output amplifiers are push-pull and the scope incorporates a 1 V peak-to-peak calibrating source, step attenuated and frequency compensated vertical input, plastic molded capacitors and top quality parts throughout. The 11-tube circuit features a 5UP1 cathode ray tube, and provision is made for Z-axis input for intensity modulation of the beam. Frequency response of the horizontal amplifier is within ± 1 db from 1 CPS to 200 kc. Horizontal sensitivity is 0.3 volts RMS per inch. Construction is simplified through the use of two metal circuit boards and precut, cable wiring harness. Shpg. Wt. 22 lbs.

GENERAL PURPOSE 5" OSCILLOSCOPE KIT

For servicing and routine laboratory work this fine kit is a favorite with technicians throughout the country. It incorporates many extras not expected at this low price. Features wide vertical amplifier frequency response, extended sweep generator operation, and improved stability. Frequency response of the vertical amplifier is within ± 3 db from 4 CPS to 1.2 mc. Vertical sensitivity is .09 volts RMS per inch at 1 kc. Sweep generator functions reliably from 20 CPS to over 150 kc. A modern etched circuit board is featured for high stability and reduces assembly time considerably. Standard components are mounted on this board with each position clearly marked preventing wiring errors. Both vertical and horizontal amplifiers are push-pull types. Uses a 5BP1 CRT. Provision for external or internal sweep or sync, built in 1 V peak-to-peak reference voltage and calibrated grid screen. An adjustable "spot shape" control is provided to insure a sharp trace. Input to the vertical amplifiers is through a step attenuated, frequency compensated circuit. The OM-3 is an extremely versatile instrument and has a multitude of practical uses in electronic testing fields. Particularly useful in alignment of television receivers, for testing audio amplifiers and circuits, and checking the quality of modulated RF signals in Ham Radio transmitters. Shpg. Wt. 22 lbs.



Equip Your Service Bench...



HEATHKIT
CD-1 \$59⁹⁵

Cash In Now On Color TV

- ★ 10 VERTICAL COLOR BARS
- ★ CRYSTAL CONTROLLED ACCURACY
- ★ CHOICE OF 6 DIFFERENT PATTERNS

COLOR BAR AND DOT GENERATOR KIT

Colored television is now a reality and as the number of these sets increase the need for a reliable service instrument is apparent. Nothing on the market... in this type of generator has as many features as the CD-1 at such a tremendous price saving. This unit combines two basic color service instruments, a color bar generator, and white dot generator in one versatile portable unit which has crystal controlled accuracy and stability for steady locked-in patterns (requires no external sync leads). Color receivers converged with the CD-1 will still be converged properly on a television program from the station. The 13-tube circuit has been carefully laid out for ease of assembly and provides choice of six different patterns. Produces white-dots, cross hatch, horizontal and vertical bars, ten vertical color bars, and a new shading bar pattern for screen and background adjustments. Variable RF output on any channel from 2 to 6. Positive or negative video output, variable from 0 to 10 volts peak-to-peak. Crystal controlled sound carrier with off-on switch. Voltage regulated power supply uses long-life silicon rectifiers. Kit includes three crystals and test lead, plus an information packed instruction manual covering convergence, and screen and background adjustments of a color TV set. Compare with other generators on the market and you will see that this instrument is loaded with extras and top quality all the way through. Shpg. Wt. 13 lbs.



HEATHKIT
TS-4A \$49⁵⁰

For fast,
easy alignment
of TV sets



HEATHKIT
AG-10 \$49⁹⁵

Sine and
square waves for
countless uses



HEATHKIT
MM-1
\$29⁹⁵

High accuracy
in a
portable meter



HEATHKIT
M-1
\$17⁹⁵

An all-round
meter of
many uses

TV ALIGNMENT GENERATOR KIT

This generator has many special design features for flexible, easy operation and reliability. The all-electronic sweep circuit insures stability and covers 3.6 mc to 220 mc in four bands. Sweep deviation is controllable from 0 to 42 mc. Crystal and variable marker oscillators are built in. Crystal (included with kit) provides output at 4.5 mc and multiples thereof. Variable marker provides output from 19 to 60 mc on fundamentals and from 57 to 180 mc on harmonics. Effective two-way blanking and phasing control also provided. A truly outstanding number of features at a tremendous price saving. Shpg. Wt. 16 lbs.

SINE-SQUARE GENERATOR KIT

High quality sine and square waves are produced by this generator over a wide range. Frequency response is ± 1.5 db from 20 CPS to 1 mc on both sine and square waves, with less than .25% sine wave distortion, 20 to 20,000 CPS. Output impedance is 600 ohms on sine wave and 50 ohms on square wave (except on 10 volt range). Square wave rise time less than .15 microseconds. Five-position bandswitch—continuously variable tuning—shielded oscillator circuit—separate step and variable output attenuators in ranges of 10, 1 and .1 volts with extra range of .01 volt on sine wave. Shpg. Wt. 12 lbs.

20,000 OHMS/VOLT VOM KIT

This meter is ideal for use in field applications where accuracy is important. Employs a 50 μ a $4\frac{1}{2}$ " meter, and features 1% precision multiplier resistors for high accuracy. Requires no external power for operation (batteries supplied). Sensitivity is 20,000 ohms-per-volt DC and 5,000 ohms-per-volt AC. Measuring ranges are 0-1.5, 5, 50, 150, 500, 1500 and 5,000 volts AC and DC. Measures direct current in ranges of 0-150 μ a, 15 ma, 150 ma, 500 ma and 15 a. Resistance multipliers are x 1, x 100 and x 10,000. Covers -10 db to +65 db. Batteries and test leads are also included with this kit. Shpg. Wt. 6 lbs.

HANDITESTER KIT

Small enough to carry with you wherever you go, this fine handitester is ideal for use in portable applications when making tests away from the work bench or as an "extra" meter in the service shop, when the main instruments are occupied. The combination function-range switch simplifies operation. Measures AC or DC voltage from 0-10, 30, 300, 1000 and 5000 volts. Direct current ranges are 0-10 ma and 0-100 ma. Ohmmeter ranges are 0-3000 and 0-300,000. Top quality precision components employed throughout. Very popular with home experimenters and electricians. Shpg. Wt. 3 lbs.

with Low-Cost Dependable Heathkits



ETCHED CIRCUIT VTVM KIT

The fact that this instrument is outselling all other VTVM's says a great deal about its accuracy, reliability, and overall quality. The precision and quality of the components used in this VTVM cannot be duplicated at this price through any other source. Its attractive appearance as well as its performance will make you proud to own it. A large 4½" panel meter is used for indication, with clear, sharp calibrations for all ranges. Front panel controls consist of a rotary function switch and a rotary range selector switch, zero-adjust and ohms-adjust controls. Precision 1% resistors are used in the voltage divider circuit. An etched circuit board is employed for most of the circuitry, cutting assembly time and eliminating the possibility of wiring errors. It also assures duplication of laboratory instrument performance. This multi-function VTVM will measure AC voltage (RMS), AC voltage (peak-to-peak), DC voltage and resistance. There are 7 AC (RMS) and DC voltage ranges of 1.5, 5, 15, 50, 150, 500 and 1500. In addition there are 7 peak-to-peak AC ranges of 0-4, 14, 40, 140, 400, 1400 and 4,000. Seven ohmmeter ranges providing multiplying factors of x 1, x 10, x 100, x 1000, x 10 k, x 100 k and x 1 megohm. Center scale resistance readings are 10, 100, 1000, 10 k, 100 k ohms, 1 megohm and 10 megohms. A zero-center scale db range is also provided. Battery and test leads included with kit. Shpg. Wt. 7 lbs.

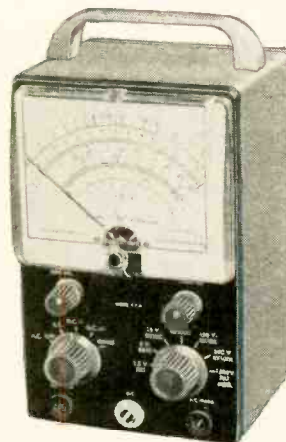

HEATHKIT
V-7A
\$24.50

**World's largest selling
VTVM kit**

- ★ LARGE EASY-TO-READ 4½" 200 UA METER
- ★ 1% PRECISION RESISTORS EMPLOYED FOR HIGH ACCURACY



HEATHKIT
C-3
\$19.50

**Checks all types of
condensers accurately**



HEATHKIT
T-4
\$19.95

**Locate faults quickly
by tracing signals**



HEATHKIT
SG-8
\$19.50

**Easy-to-build—prewound
and calibrated coils**

CONDENSER CHECKER KIT

Check unknown condenser and resistor values quickly and accurately. Capacity measurements are made in four ranges of .00001 mfd-.005 mfd; .001 mfd-.5 mfd; .1 mfd-50 mfd; 20 mfd-1,000 mfd. Checks paper, mica, ceramic, and electrolytic condensers. Leakage test provides switch selection of five polarizing voltages, 25 volts to 450 volts DC to indicate condenser operating quality under actual load conditions. Electron beam "eye" tube indicates balance and leakage. A spring return test switch automatically discharges condenser under test and eliminates shock hazard to the operator. Measures resistance from 100 ohms to 5 megohms in two ranges. Shpg. Wt. 7 lbs.

VISUAL-AURAL SIGNAL TRACER KIT

Here is a brand new signal tracer completely re-designed with compact dimensions and new circuit layout. Features built-in speaker and electron beam "eye" tube for signal indication and a unique noise locator circuit. Ideal for use in A.M. FM and TV circuit investigation. RF and audio inputs are provided in one convenient probe with switch-on probe to select either input. Useful for checking microphones, phono cartridges, record changers, tuners, etc. Makes a handy substitution speaker for servicing TV sets at the shop. Transformer operated for safety and high efficiency. Complete with test leads and informative construction manual. Shpg. Wt. 6 lbs.

RF SIGNAL GENERATOR KIT

Save valuable time in aligning RF tuned circuits of all kinds with this easy-to-use kit. Also a quick way to trace signals in faulty RF, IF and audio circuits. Designed for general service applications—the SG-8 covers 160 kc to 110 mc on fundamentals in five bands, and from 110 mc to 220 mc on calibrated harmonics. The entire oscillator circuit is built on a special sub-chassis, using prewound and calibrated coils. No further calibration is required so it is ready to use as soon as construction is completed. RF output is in excess of 100,000 microvolts, controlled by both step and continuously variable controls. Complete with output cable and instructions. Shpg. Wt. 8 lbs.

HEATH COMPANY • a subsidiary of Daystrom, Inc. • **Benton Harbor 20, Mich.**

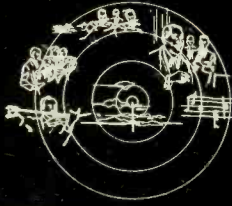

Enjoy Rich 3 Dimension Sound...

Beautifully Styled with Plenty of Room for the Most Complete Stereo System

AVAILABLE IN THE FOLLOWING MODELS:
 Model SE-1B—Stereo Equipment Cabinet (birch)
 Model SE-1M—Stereo Equipment Cabinet (mahogany)

\$149⁹⁵ ea.

Model SC-1BR—Stereo Wing Speaker Enclosure (birch—right end)
 Model SC-1BL—Stereo Wing Speaker Enclosure (birch—left end)
 Model SC-1MR—Stereo Wing Speaker Enclosure (mahogany—right end)
 Model SC-1ML—Stereo Wing Speaker Enclosure (mahogany—left end)

\$39⁹⁵ ea.

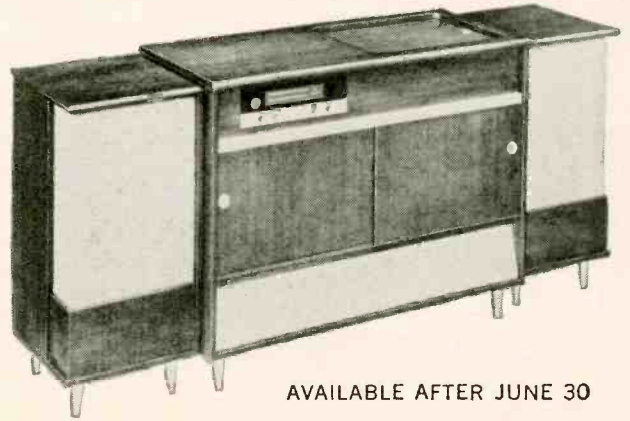

AVAILABLE AFTER JUNE 30

STEREO EQUIPMENT CABINET KIT

Imagine!... Stereophonic sound in your own home. This superbly designed cabinet holds all of your hi-fi stereo equipment and lends striking elegance to your living room. The attractive gold and black panels, trim and hardware brilliantly highlight the overall effect. Rich toned grille cloth, flecked in gold and black, complement the cabinet. The unit has ample room provided for an AM-FM tuner, tape deck, stereo pre-amplifier, amplifiers, record changer, record storage and speakers. Beautifully grained 3/4" solid core Philippine mahogany or select birch plywood is used for construction. The top features a shaped edge and sliding top panel for easy access to the stereo tape deck and stereo preamplifier. Sliding doors are employed for convenient front access to the

changer and record storage compartment. All parts of the cabinet are pre-cut and pre-drilled for simple assembly. The speaker wings and center cabinet may be purchased separately if desired. Note: the kit is delivered equipped with panels pre-cut to accommodate Heathkit components and also blank panels to cut out for your own equipment. Measurements of the individual component areas follow: tape deck and pre-amplifier area 20 3/4" L. x 17 3/4" W. x 10" D., record changer area 21" W. x 16" D. x 9 5/8" H., record storage area 22 5/8" W. x 14 1/2" H. x 12 1/2" D., speaker wing area (inside) 14" W. x 29 1/2" H. x 15 3/4" D., AM-FM Tuner area 20 1/2" W. x 5 1/4" H. x 14" D., amplifier (2 areas) 15 1/4" W. x 10 3/4" H. x 13 1/4" D.

Model HH-1B Birch
 Model HH-1M Mahogany
 Now only **\$299⁹⁵** each



The Same Superior Performance At a New Low Price



HEATHKIT SS-2 **\$39⁹⁵**

OPTIONAL LEGS EXTRA

Economical Hi-Fi For Your Home

"LEGATO" HI-FI SPEAKER SYSTEM KIT

The increasing sales of the Legato has made more economical quantity production possible so we are passing the savings on to you by offering you this magnificent speaker system at a reduced price. Truly a "queen" among hi-fi speaker systems, the Legato was specially designed to meet and surpass the most stringent requirements of high fidelity sound reproduction. Two 15" Altec Lansing low frequency drivers cover frequencies of 25 to 500 CPS while a specially designed exponential horn with high frequency driver covers 500 to 20,000 CPS. A unique crossover network is built in making electronic crossovers unnecessary. Internal reflections are absorbed by splayed back panel and a 3" fiber glass lining. The Legato emphasizes simplicity of line and form to blend with modern or traditional furnishings. Cabinet construction is 3/4" veneer surface plywood in either African mahogany or white birch and measures 41" L. x 22 1/4" D. x 34" H. All parts are pre-cut and pre-drilled for easy assembly. Shpg. Wt. 195 lbs.

"BASIC RANGE" HI-FI SPEAKER SYSTEM KIT

True high fidelity performance at modest cost make this basic speaker system a spectacular buy for any hi-fi enthusiast. The amazing performance of this popular kit is made possible by the use of high quality speakers in an enclosure specially designed to receive them. The cabinet is a ducted port bass reflex type enclosure 11 1/2" H. x 23" W. x 11 3/4" D. It features an 8" mid range woofer to cover 50 to 1600 CPS and a compression-type tweeter with flared horn covering 1600 to 12,000 CPS. Both speakers are by Jensen. The adjustable flared tweeter horn allows speaker to be used in either upright or horizontal position. The cabinet is constructed of 1/2" veneer surfaced plywood suitable for light or dark finish of your choice. All wood parts are pre-cut and pre-drilled for easy assembly. Shpg. Wt. 25 lbs.

Attractive brass tip accessory legs convert SS-2 into attractive console. Legs screw into brackets provided. All hardware included. Shpg. Wt. 3 lbs. No. 91-26 \$4.95

with a Heathkit Stereo System

HEATHKIT

HIGH FIDELITY STEREO TAPE DECK KIT

For your unparalleled enjoyment in the world of stereophonic sound Heathkit brings you an all new stereo tape deck. This tape deck is a precision engineered instrument providing monaural record/playback, and stereo playback of prerecorded tapes. Incorporates three separate heads, erase-record-stereo playback (stacked). The mechanical tape deck assembly is supplied complete. You build only the record and playback circuit employing two etched circuit boards for ease of wiring. Low noise EF-86 tubes in input stages and efficient push-pull bias-erase oscillator insures complete freedom from hum and noise in recording and playback. Provision made for 3¾ and 7½ IPS tape speed selected by a push button. Deck handles up to 7" reels of tape. Other features are: provision for monitoring tape while recording, built-in VU meter for proper recording level, pause control for editing tape, "fast forward" and "rewind" control. Frequency response at 7½ IPS tape speed is ±2 db from 40 to 12,000 CPS, at 3¾ IPS speed 40 to 6,000 CPS. Signal-to-noise ratio is 55 decibels with less than 1% total harmonic distortion. NARTB tape playback equalization. A safety interlock button prevents accidentally switching to record position causing erasure of recorded tapes. Shpg. Wt. 33 lbs.

Model TR-1C monaural tape deck incorporates all of the features described for the model TR-1D with the exception of stereo playback. \$131.95.

No. C-TR-1C conversion kit converts model TR-1C to include stereo function of model TR-1D. \$15.95.



HEATHKIT
TR-1D

\$143⁹⁵

**Preassembled Tape Mechanism . . .
You Build Only Electronic Circuit**

AVAILABLE AFTER JUNE 30



HEATHKIT
SS-1B
\$99⁹⁵

**Fill out the Hi-Fi Range
of Your SS-2 Speaker**

AVAILABLE AFTER JUNE 30

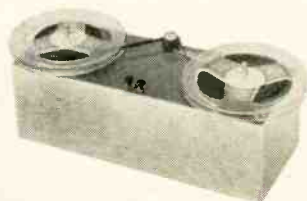

HEATHKIT
SW-1
PRICE TO BE
ANNOUNCED

Save Time Rewinding Tape

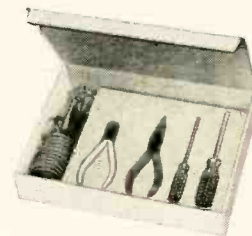

HEATHKIT
TK-1
\$9⁹⁵

**All The Tools You Need For
Building Heathkits**

"RANGE EXTENDING" HI-FI SPEAKER SYSTEM KIT

This is not a complete speaker system in itself, but is designed to extend the range of the SS-2. The SS-1B uses a 15" woofer and a small super tweeter to supply the very high and very low frequencies to fill out the response of the basic SS-2. The SS-2 and SS-1B when used together, form an integrated four speaker system. The SS-2 and SS-1B combination provide an overall response of ±5 db from 35 to 16,000 CPS. The kit includes circuit for crossover at 600, 1600 and 4,000 CPS. Impedance is 16 ohms and power rating is 35 watts. A control is also provided to limit output of super tweeter. The handsome cabinet measures 29" H. x 23" W. x 17½" D. Constructed of beautiful ¾" veneer surface plywood. Complete step-by-step instructions make this kit easy to build. No wood-working experience required. Shpg. Wt. 80 lbs.

"SPEEDWINDER" KIT

This handy device leaves your tape recorder free for operation while it rewinds tape at the rate of 1200' in 40 seconds. Prevents unnecessary wear to the tape and recorder by eliminating wear against guides and heads. It will handle up to 10½" tape reels as well as 800' reels of 8 and 16 millimeter film. A very useful aid to operators of movie projection equipment. The Heathkit Speedwinder features an automatic shutoff which prevents whipping of tape when it has rewound. A manual shutoff is also provided. An automatic braking device is built in for protection against power failure. Driven by a heavy duty four pole motor. Handsome cabinet is constructed of furniture grade plywood. Step-by-step instructions are provided to make this kit easy to assemble even by one with no experience.

COMPLETE TOOL SET

A clear illustration of just how easy Heathkit building is. The pliers, diagonal sidecutters, two screw drivers and soldering iron are all the basic tools you need for building practically any Heathkit. Pliers and sidecutters are equipped with insulated rubber handles. The American Beauty soldering iron has a replaceable tip to facilitate cleaning. All the tools are of top quality case hardened steel for rugged duty and long life. With these simple, inexpensive tools in your hand you need not be afraid to tackle the most elaborate kit. The manual included with this handy kit provides you with many useful tips on the use and care of your tools. It shows the all important step of making proper solder connections. A truly worthwhile investment for the beginner in electronic kit building. Shpg. Wt. 3 lbs.

HEATH COMPANY • a subsidiary of Daystrom, Inc. • Benton Harbor 20, Mich.

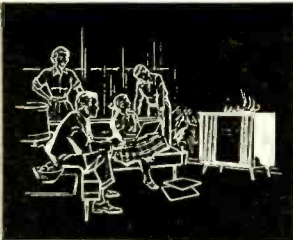

Plan Your Hi-Fi System...

AVAILABLE AFTER JUNE 30



HEATHKIT
SP-2 **\$56⁹⁵**

Model SP-1 (monaural) **\$37.95**
Model C-SP-1 (converts SP-1 to SP-2) **\$21.95**

**Control both stereo
channels simply
and conveniently**

MONAURAL-STEREO PREAMPLIFIER KIT

This expertly designed preamplifier provides all the controls required for either standard monaural (single channel) or stereo (dual channel) sound reproduction. Features building block design... you can start with a basic preamplifier and add a second channel for stereo later on, without rewiring. Second channel plugs in for fast conversion. The complete model SP-2 (stereo) features twelve separate inputs, six on each channel with input level controls. Six dual-concentric controls consist of: two 8-position selector switches, two bass, two treble, two volume level and two loudness controls, a scratch filter switch and a 4-position function switch (separate on-off switch). The function switch provides settings for stereo, two-channel mix, channel A or B for monaural use. Inputs consist of tape, mike, mag phono and three high-level inputs. Tape input has NARTB equalization and input selector provides for RIAA, LP, 78 record compensation. EF86 tubes are used in the input stages along with hum balance controls to assure low hum and noise. Two cathode follower outputs with level controls provided in addition to two separate tape outputs for stereo recording. A remote balance control with twenty feet of cable allows balancing the stereo system from listening position. Construction is greatly simplified through the use of two printed circuit boards (one in each channel) and encapsulated printed circuits. The beautiful vinyl clad steel cover has leather texture in black with inlaid gold design. Built-in power supply.



HEATHKIT
WA-P2
\$19⁷⁵

**Finger-tip controls for
your operating convenience**



HEATHKIT
UA-1
\$21⁹⁵

**A low cost
versatile performer**

"MASTER CONTROL" PREAMPLIFIER KIT

Designed as a control center for basic amplifiers the WA-P2 provides you with true high fidelity performance for the finest audio systems. Five switch-selected inputs accommodate a record changer, tape recorder, AM-FM tuner, TV receiver, microphone, etc., each with level control. Provision is also made for a tape recorder output. Ideal for "remote" installations, the WA-P2 features a low impedance cathode-follower output circuit allowing greater length of output lead. Full frequency response is obtained within $\pm 1\frac{1}{2}$ db from 15 to 35,000 CPS and will do full justice to the finest available program sources. Equalization is provided for records through separate turnover and rolloff switches for LP, RIAA, AES, and early 78's. A special hum balance control allows setting for minimum hum level. Power for operation is required from basic amplifier or external source. Shpg. Wt. 7 lbs.

"UNIVERSAL" 12-WATT AMPLIFIER KIT

A true high fidelity performer in every sense of the word, the UA-1 makes an ideal basic amplifier for any hi-fi system and is a perfect addition to gear your present hi-fi system for stereo sound. Uses 6BQ5/EL84 push-pull output tubes for less than 2% harmonic distortion throughout the entire audio range (20 to 20,000 CPS) at full 12 watt output. The on-off switch is located right on the chassis and an octal socket is provided for connecting a preamplifier for remote control operation. The specially designed output transformer provides excellent stability and frequency response. Taps for 4, 8 and 16 ohm speakers, with switched damping for "unity" or "maximum" on the 16-ohm tap. An input level control is provided for use in wired music systems where a preamplifier is not required. This versatile unit is the latest addition to the fine line of Heathkit basic amplifiers. Shpg. Wt. 13 lbs.

With Flexible Heathkit Components

HEATHKIT

DELUXE AM-FM TUNER KIT

Outstanding features in both styling and circuitry are combined in this 16-tube deluxe AM-FM combination tuner to bring you the very finest in program sources, for your listening enjoyment. Features include three circuit boards for easy construction and high stability—prewired, prealigned FM front end—built-in AM rod antenna—tuning meter—AFC (automatic frequency control) with on-off switch and flywheel tuning. AM and FM circuits are separate and individually tuned making it ideal for stereo applications. Cathode follower outputs with individual controls are provided for both AM and FM. Other features include variable AM bandwidth, 10 kc whistle filter, tuned-cascade FM front end, FM AGC and amplified AVC for AM. The unique IF limiter design automatically provides the number of limiting and IF stages required for smooth non-flutter reception. The silicon diode power supply is extremely conservatively rated and is fuse protected assuring long service life. A tuning meter shows when the station is tuned-in for clearest reception on AM or FM. Use of three circuit boards greatly simplifies construction of circuit, you do only a minimum of wiring. All IF transformers and coils are prealigned so it will be ready to operate as soon as construction is completed. Appearance of this top-quality unit is further enhanced by the vinyl-clad steel cover in black with inlaid gold design. A multiplex jack is provided for addition of converter unit to receive multiplex stereo broadcasts on FM. A top dollar value.

AVAILABLE AFTER JUNE 30



HEATHKIT
PT-1 **\$89⁹⁵**

**A deluxe AM-FM
tuner combination
loaded with extras!**

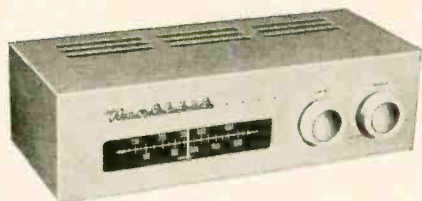

HEATHKIT
BC-1A
\$25⁹⁵

Wide range broadcast reception



HEATHKIT
FM-3A
\$25⁹⁵

Enjoy static-free FM entertainment

HIGH FIDELITY AM TUNER KIT

This AM tuner was designed especially for high fidelity applications. It incorporates a special detector using crystal diodes, and the IF circuit features broad bandwidth to assure low signal distortion. Audio response is ± 1 db from 20 CPS to 9 kc. with 5 db of pre-emphasis at 10 kc to compensate for station rolloff. Sensitivity and selectivity are excellent and the tuner covers the entire broadcast band from 550 to 1600 kc. Quiet performance is assured by a 6 db signal-to-noise ratio at 2.5 uv. Prealigned RF and IF coils eliminate the need for special alignment equipment. Incorporates AVC, two outputs, two antenna inputs, and built-in power supply. Edge-lighted glass slide rule dial for easy tuning. Your "best buy" in an AM tuner. Shpg. Wt. 9 lbs.

HIGH FIDELITY FM TUNER KIT

FM programming, your least expensive source of high fidelity will provide you with years of real enjoyment. This beautifully styled FM tuner features broad-banded circuits for full fidelity and better than 10 uv sensitivity for 20 db of quieting to pull in stations with clarity and full volume. Covers the complete FM band from 88 to 108 mc. Stabilized, temperature-compensated oscillator assures negligible drift after initial warmup. A ratio detector provides high-efficiency demodulation without sacrificing hi-fi performance. IF and ratio transformers are prealigned, as is the front end tuning unit, making special alignment equipment unnecessary. Edge-lighted glass slide rule dial for easy tuning. You need not wait to have FM in your home at this low price. Shpg. Wt. 8 lbs.

HEATH COMPANY • a subsidiary of Daystrom, Inc. • Benton Harbor 20, Mich.

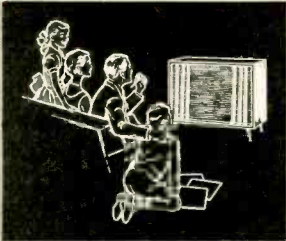

You can be sure you're buying High Fidelity

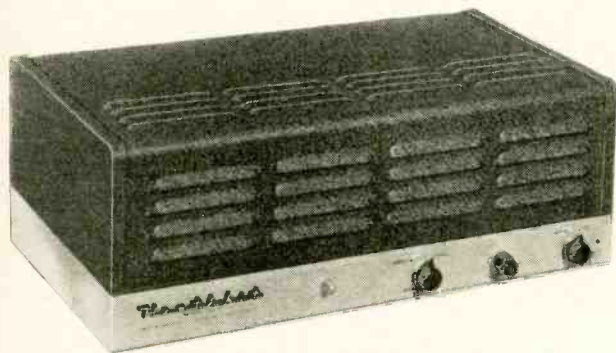

HEATHKIT
W-7M

\$54⁹⁵

**55 watts of hi-fi power at
only \$1 per watt**

- ★ BEAUTIFULLY STYLED IN BLACK AND GOLD
- ★ UNITY OR MAXIMUM DAMPING

**"EXTRA PERFORMANCE"
55 WATT HI-FI AMPLIFIER KIT**

Another Heathkit first! An honestly rated high power amplifier with many top quality features at less than a dollar per watt. Full audio output is conservatively rated at 55 watts from 20 CPS to 20 kc with less than 2% total harmonic distortion throughout the entire range. Unique paired output connections permit instant switch selection of "unity" or "maximum" damping factors for all 4, 8 or 16 ohm speakers. Each output has an optimized current feedback circuit for unity damping so that there will be no compromise in performance when any of the impedances is used. This current feedback circuitry is entirely shorted out when not in use to obtain the highest possible damping factor. Features include level control and "on-off" switch right on the chassis plus provision for remote control from preamp, etc. Famous "bas-bal" circuit conveniently balances EL-34 output tubes. These heavy duty push-pull tubes operate into a high quality tapped-screen transformer designed especially for this unit. A 70-volt output on the transformer provides for P.A. or large music systems. The silicon diode power supply features a protection device that controls current until tubes have warmed up, greatly increasing service life of all components. The stylish black and gold case measures 6" H. x 8½" D. x 15" W. Convenient pilot light on the chassis. Thoughtful circuit layout makes this kit easy to build. Dollar for watt you can't beat this buy. Shipped express only. Shpg. Wt. 28 lbs.

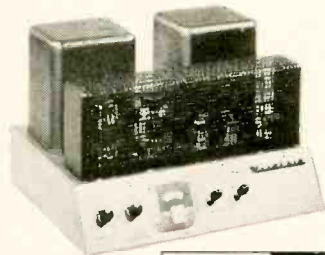

HEATHKIT
W-6M

\$109⁹⁵

**Plenty of Reserve Power
Without Distortion**

"HEAVY DUTY" 70-WATT HI-FI AMPLIFIER KIT

Here is an amplifier that will provide the extra "push" needed to drive any of the fine speaker systems available today, for truly fine performance at any power level. Silicon-diode rectifiers are used to assure long life and a heavy duty transformer gives you extremely good power supply regulation. Variable damping control provides optimum performance with any speaker system. Quick change plug selects 4, 8 and 16 ohms or 70 volt output and the correct feedback resistance. Frequency response at 1 watt is from 5 CPS to 80 kc with controlled HF rolloff above 100 kc. At 70 watts output harmonic distortion is below 2%, 20 to 20,000 CPS and IM distortion is below 1%, 60 and 6,000 CPS. Hum and noise 88 db below full output. Metered balance circuit. Designed especially for easy assembly and years of dependable service. Shipped express only. Shpg. Wt. 52 lbs.



HEATHKIT
W-5M

\$59⁷⁵

**Top-Flight Performance
for the Critical Listener**

25-WATT HI-FI AMPLIFIER KIT

Considered top value in its power class by leading independent research organizations, the W-5M incorporates all the design features required by the super critical listener. Features include a specially designed Peerless output transformer and KT66 tubes. The circuit is rated at 25 watts and will follow instantaneous power peaks of a full orchestra up to 42 watts. A "tweeter saver" suppresses high frequency oscillation and a new type balancing circuit facilitates adjustment of the "dynamic" balance between output tubes. Frequency response is ±1 db from 5 CPS to 160,000 CPS at 1 watt and within 2 db from 20 to 20,000 CPS at full 25 watts output. Harmonic distortion is less than 1% at 25 watts and IM distortion is 1% at 20 watts (60 and 3,000 CPS, 4:1). Hum and noise are 99 db below 25 watts for truly quiet performance. Rich black and gold colored styling. Shipped express only. Shpg. Wt. 31 lbs.



HEATHKIT
W4-AM

\$39⁷⁵

**Faithful Sound Reproduction
with Minimum Investment**

20-WATT HI-FI AMPLIFIER KIT

This fine amplifier will amaze you with its outstanding performance. It features a true Williamson circuit with extended frequency response, low distortion, and low hum levels. Enjoy true hi-fi with only a minimum investment compared to other units on the market. 5881 tubes and a special Chicago-Standard output transformer are employed to give you full fidelity at minimum cost. Frequency response extends from 10 CPS to 100kc within ±1 db at 1 watt assuring you of full coverage of the audio range. Clean, clear sound amplification takes place in circuits that hold harmonic distortion at 1.5% and IM distortion below 2.7% at full 20 watt output. Hum and noise are 95 db below full output. Taps on the output transformer are at 4, 8 or 16 ohms to match the speaker system of your choice. An outstanding performer, this investment will bring you years of listening enjoyment. Shipped express only. Shpg. Wt. 28 lbs.

All basic amplifiers recommended for use with model WA-P2, SP-1 or SP-2 preamplifiers

...When You Buy Heathkits



"BOOKSHELF" 12-WATT AMPLIFIER KIT

The model EA-2 combines eye-pleasing style and color with many extra features for high quality sound reproduction. This fine amplifier provides full range frequency response from 20 to 20,000 CPS within ± 1 db. Harmonic distortion is less than 1% at full 12 watt output over the entire range (20-20,000 CPS). IM distortion is less than 1.5% at 12 watts with low hum and noise. Miniature tubes are used throughout the advanced circuitry, including EL84 output tubes in a push-pull tapped-screen output circuit using a special designed output transformer. Transformer has taps at 4, 8 and 16 ohms. The model EA-2 has its own built-in preamplifier with provision for three separate inputs, mag phono, crystal phono and tuner. The mag phono input features RIAA equalization. Separate bass and treble controls are provided with boost and cut action. A special hum-balance control assures quiet operation. The luxury styled cabinet has a smooth simulated leather texture in black with inlaid gold design and is constructed of vinyl plastic bonded to steel. It resists scuffing, wear, abrasion, and chemicals. The front panel features brushed-gold trim and buff knobs with gold inserts for a very pleasing appearance. An amber neon pilot lamp indicates when the amplifier is on. Cabinet measures 12½" W. x 3¾" D. x 4¾" H. making it suitable for use on a bookshelf, end table, etc. High quality is emphasized throughout for performance matching amplifiers costing many times more. Shpg. Wt. 15 lbs.



HEATHKIT
EA-2 **\$27⁹⁵**

*Combines beauty, style
and quality*

- ★ LESS THAN 1% DISTORTION AT FULL OUTPUT OVER ENTIRE AUDIO RANGE.
- ★ BUILT-IN PREAMPLIFIER



HEATHKIT
A9-C **\$35⁵⁰**

**A Bargain Package of
Power and Performance**



HEATHKIT
AV-3 **\$29⁹⁵**

**Invaluable for
Hi-Fi Testing**



HEATHKIT
AW-1 **\$29⁵⁰**

**Measure Exact
Power Output**

GENERAL-PURPOSE 20-WATT AMPLIFIER KIT

The A9-C combines a preamplifier, main amplifier and power supply all on one chassis providing a compact unit to fill the need for a good high fidelity amplifier with a moderate cash investment. Designed primarily for home installations, it is also capable of fulfilling P.A. requirements. The preamplifier section features four separate switch selected inputs. Separate bass and treble tone controls offer 15 db boost and cut. A true high fidelity performer, the A9-C covers 20 to 20,000 CPS within ± 1 db. Front panel is detachable, and can be installed on the outside of a cabinet where the chassis comes through, for custom installations. A fine unit with which to start your hi-fi system. Shpg. Wt. 23 lbs.

AUDIO VTVM KIT

Critical AC voltage measurements are made easy with this high quality vacuum tube voltmeter which emphasizes stability, broad frequency response and sensitivity. Features large 4½" 200 microampere meter, with increased damping in the meter circuit for stability in low frequency tests. Extremely high voltage range handles measurements from a low value of 1 millivolt to a maximum of 300 volts. AC (RMS) voltage ranges are: 0-0.1, .03, .1, .3, 1, 3, 10, 30, 100 and 300 volts. Db ranges cover -52 to +52 db. Employs 1% precision multiplier resistors for maximum accuracy. High input impedance (1 megohm at 1,000 CPS). Frequency response is essentially flat from 10 CPS to 200 kc. Shpg. Wt. 6 lbs.

AUDIO WATTMETER KIT

Here is a fine meter to accurately measure output wattage. Five power ranges cover 0-5 mw, 50 mw, 500 mw, 5 w and 50 w full scale. Five switch selected db ranges cover -10 db to +30 db. All indications are read directly on the large 4½" 200 ua meter. Frequency response is ± 1 db from 10 CPS to 250 kc. External or internal load resistors are selected with convenient front panel switch. Non-inductive load resistors are built in for 4, 8, 16 or 600 ohms impedance. Precision multiplier resistors are used for high accuracy and incorporates a crystal diode bridge for wide-range frequency response. Modern styling and convenient front panel design. Cabinet is ventilated to allow efficient cooling of load resistors. Shpg. Wt. 7 lbs.

HEATH COMPANY • a subsidiary of Daystrom, Inc. • **Benton Harbor 20, Mich.**

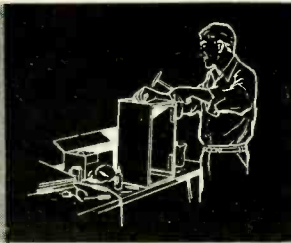

Easy to Buy - Easy to Build - Easy to Use...



CONTEMPORARY
Model CE-1B Birch
Model CE-1M Mahogany

HEATHKIT
CE-1
\$4395
each



TRADITIONAL
Model CE-1T Mahogany

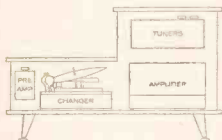

CHAIRSIDE ENCLOSURE KIT

This Chairside Enclosure lets you combine all of your hi-fi equipment into one compact control center and, at the same time add a beautiful piece of furniture to your home. The CE-1 is designed to house the AM and FM tuners (BC-1A and FM-3A) and the WA-P2 preamplifier along with the majority of record changers which will fit into the space provided. Adequate room is available in the rear of the unit to house any of the Heathkit amplifiers designed to operate with the WA-P2. The enclosure is flexible enough to give you a large choice in component installation. If only one tuner and the preamplifier are used, the two units can be installed in the tilt-out drawer, or if more convenient, either unit can be placed in the space provided in front of the changer compartment. The tilt-out shelf can be installed on either right or left side and the lift-top lid is similarly designed to lift from either side depending on your choice during construction! Good ventilation is achieved through appropriately placed slots in the bottom and back of the enclosure. Overall dimensions are 18" W. x 24" H. x 35½" D. The changer compartment measures 17¾" L. x 16" W. x 9⅝" D. All parts are precut and predrilled for easy assembly and attractive hardware is supplied to match each style. The contemporary cabinet is available in either mahogany or birch and the traditional cabinet is available in mahogany only. Furniture grade plywood can be finished to your taste. Shpg. Wt. 46 lbs.

Combine all your Hi-Fi equipment
in this attractive cabinet



HEATHKIT
AG-9A **\$34.50**

Your own source of
Hi-Fi audio signals



HEATHKIT
AA-1 **\$49.95**

3 Audio test instruments
in one compact unit



HEATHKIT
HD-1 **\$49.50**

Check amplifier
distortion quickly

AUDIO SIGNAL GENERATOR KIT

The model AG-9A is "made to order" for high fidelity applications, and provides quick and accurate selection of low-distortion signals from 10 CPS to 100 kc. Three rotary switches select two significant figures and a multiplier to determine audio frequency. Incorporates step-type and a continuously variable output attenuator. Output indicated on large-4½" panel meter, calibrated in volts and db. Attenuator system operates in 10 db steps, corresponding to meter calibration, in ranges of 0-.003, .01, .03, .1, .3, 1, 3 and 10 volts RMS. "Load" switch permits use of built-in 600-ohm load, or external load of different impedance. Output and frequency indicators accurate to within ± 5%. Distortion less than .1 of 1% between 20 and 20,000 CPS. Shpg. Wt. 8 lbs.

AUDIO ANALYZER KIT

Complete high fidelity testing facilities are yours in the AA-1. It combines the functions of three separate instruments; an AC VTVM, audio wattmeter and a complete 1M analyzer with filters and high and low frequency oscillators built in. VTVM ranges are: 0-.01, .03, .1, .3, 1, 3, 10, 30, 100 and 300 volts (RMS). Db scale reads from -65 to +52 dbm. Wattmeter ranges are: .15 mw, 1.5 mw, 15 mw, 150 mw, 1.5 w, 15 w and 150 w. 1M scales are 1%, 3%, 10%, 30% and 100% full scale. Provides internal load resistors of 4, 8, 16 or 600 ohms. Combining and consolidating functions reduces the number of test leads and controls required for the same test. Complete instructions are provided for easy assembly, also valuable information on use of instrument. Shpg. Wt. 13 lbs.

HARMONIC DISTORTION METER KIT

Valuable in both designing and servicing of audio circuits, the HD-1 used with an audio signal generator, will accurately measure harmonic distortion at any or all frequencies between 20 and 20,000 CPS. Distortion is read on panel meter in ranges of 0-1, 3, 10, 30 and 100% full scale. Full scale voltage ranges of 0-1, 3, 10 and 30 volts are provided for the initial reference settings. Signal-to-noise ratio is measured on a separate meter scale calibrated in db. Features high input impedance (300,000 ohms) and 1% precision resistors in the VTVM voltage divider circuit for excellent sensitivity and accuracy. High quality components insure years of dependable service. Complete instructions provided for easy assembly and operation. Shpg. Wt. 13 lbs.

Heathkits are Your Best Dollar Value

HEATHKIT

TRANSISTOR PORTABLE RADIO KIT

The overwhelming sales of this outstanding transistor portable have made a substantial price reduction possible... in addition, an all new plastic molded case adds the finishing touch to the exceptional circuitry. Six name-brand (Texas Instrument) transistors are used for extra good sensitivity and selectivity. The 4" x 6" PM speaker with heavy magnet provides excellent tone quality. Use of this large speaker and roomy chassis make it unnecessary to crowd components adding greatly to the ease of construction. Transformers are prealigned so it is ready for service as soon as construction is completed. A touchup in alignment is easily accomplished on a station by following simple instructions in manual. Alignment tool furnished. Has built-in rod-type antenna for reception in all locations. Six standard size "D" flashlight cells are used for extremely long battery life (between 500 and 1000 hours) and they can be purchased almost anywhere. Cabinet is two-tone blue molded plastic with pull-out carrying handle. Dimensions are 9½" L. x 7¼" H. x 4" D. Shpg. Wt. 6 lbs.

Model XR-1-L: Identical to XR-1-P except in genuine leather case. Rich, warm sun-tan tone. Leather carrying strap included. Shpg. Wt. 7 lbs.

Leather Case: can be purchased separately if desired. Fits all XR-1P's and XR-1's. No. 93-1. Shpg. Wt. 3 lbs. \$6.95.

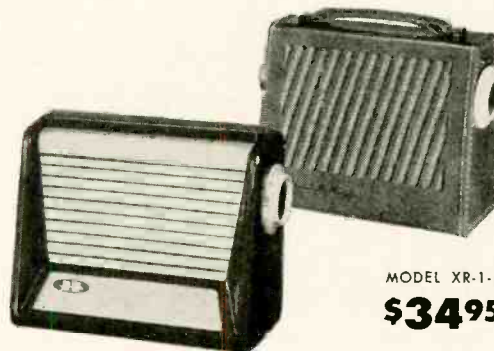

MODEL XR-1-L
\$34⁹⁵

HEATHKIT
XR-1-P **\$29⁹⁵**

Newly designed plastic case... new low price!

- ★ 4" X 6" SPEAKER FOR "BIG SET" TONE
- ★ LONG BATTERY LIFE (500 to 1000 Hours)



HEATHKIT
CT-1
\$7⁹⁵

Test condensers right in the circuit



HEATHKIT
DF-1 **\$54⁹⁵**

Pin-point your exact location



HEATHKIT
FD-1 **\$35⁹⁵ each**
(6 volt model FD-1-6)
(12 volt model FD-1-12)

Detects gas fumes



HEATHKIT
MC-1
\$42⁹⁵

Save your boat batteries

IN-CIRCUIT CAPACI-TESTER KIT

Check most capacitors for "open" or "short" right in the circuit with this handy kit. Detects open capacitors from about 50 mmf up, not shunted by an excessively low resistance value. Checks shorted capacitors up to 20 mfd (not shunted by less than 10 ohms). (Does not detect leakage nor check electrolytic condensers.) Employs a 60-cycle frequency for the short test and a 19 megacycle frequency for the open test. Uses electron beam "eye" tube for quick indication. Test leads included. Shpg. Wt. 5 lbs.

TRANSISTOR RADIO DIRECTION FINDER KIT

This transistor radio compass will double as a portable radio. Covers the standard broadcast band from 540 to 1600 kc. Ideal for use aboard boats and also on land by hunters, hikers, etc. A directional high-Q ferrite antenna rotates from the front panel to obtain a fix on a station. A 1 ma meter serves as null and tuning indicator. Prealigned IF transformers—six transistor circuit. Powered by tiny 9-volt battery with spare included. Dimensions 7½" W. x 5¾" H. x 5¾" D. Shpg. Wt. 5 lbs.

FUEL VAPOR DETECTOR KIT

Protect your boat and passengers against fire and explosion with one of these fuel vapor detector kits. Indicates the presence of fumes on a three-color "safe-dangerous" meter scale and immediately shows if it is safe to start the engine. A pilot lamp shows when the detector is operating. Easy to build and install, even by one not having previous experience. Operates from your boat battery. The kit is complete with heavy-duty neoprene insulated cable and includes spare detector unit. Shpg. Wt. 4 lbs.

MARINE CONVERTER KIT

Charge 6 or 12 volt batteries with this marine converter and battery charger. A panel mounted 25 ampere meter continuously monitors the charging current. Moisture and fungus proofed for rugged marine use. Convection cooling prevents unsafe temperature rise. The MC-1 has no moving parts, tubes nor blowers to wear out or break. Mounting brackets are supplied for easy installation on any boat. Ideal for keeping batteries fully charged or to supply extra current for appliances. Shpg. Wt. 16 lbs.

HEATH COMPANY • a subsidiary of Daystrom, Inc. • Benton Harbor 20, Mich.



New Styling - New Features...



HEATHKIT
TX-1 **\$229⁵⁰**

**Complete Versatility for Top-
Notch Amateur Communications**

- ★ NEWLY DESIGNED VFO—ROTATING SLIDE RULE DIAL
- ★ MODERN STYLING—PROVISION FOR SSB ADAPTER

"APACHE" HAM TRANSMITTER KIT

Fresh out of the Heath Company laboratories, the brand-new "Apache" model TX-1 ham transmitter features modern styling and the latest in circuitry for extra fine performance. The "Apache" is a high quality transmitter operating with a 150 watt phone input and 180 watt CW input. In addition to CW and phone operation, built-in switch selected circuitry provides for single-sideband transmission through the use of a plug-in external adapter. These SSB adapters will be available in the near future. A compact, stable and completely redesigned VFO provides low drift frequency control necessary for SSB transmission. A slide rule type illuminated rotating VFO dial with vernier tuning provides ample bandspread and precise frequency settings. The bandswitch allows quick selection of the amateur bands on 80, 40, 20, 15 and 10 meters. (11M with crystal control). This unit also has adjustable low level speech clipping and a low distortion modulator stage employing two of the new 6CA7/EL-34 tubes in push-pull class AB operation. Time sequence keying is provided for "chirpless" break-in CW operation. The final amplifier is completely shielded for greater TVI protection and transmitter stability. Die-cast aluminum knobs and front panel escutcheons add to the attractive styling of the transmitter. Pi network output coupling matches antenna impedances between 50 and 72 ohms. Shpg. Wt. 115 lbs.

\$50.00 deposit required on C.O.D. orders. Shipped motor freight unless otherwise specified.



HEATHKIT
DX-20 **\$35⁹⁵**

**An Ideal
Code Transmitter**



HEATHKIT
DX-100 **\$189⁵⁰**

**You'll be Proud to Own
This Outstanding Performer**



HEATHKIT
DX-40 **\$64⁹⁵**

**Phone & CW Facilities
at Low Cost**

DX-20 CW TRANSMITTER KIT

Designed especially for CW work, the DX-20 features high efficiency at low cost. An ideal rig for the novice or advanced-class CW operator. Plate power input is 50 watts, and covers 80, 40, 20, 15, 11 and 10 meters with single knob bandswitching. Features a single 6DQ6A tube in the final amplifier stage and a 6CL6 as a crystal oscillator. Pi network output circuit matches various antenna impedances between 50 and 1000 ohms and reduces harmonic output. Top-quality parts are featured throughout, including "potted" transformers, etc., for long service life. Complete shielding to minimize TVI. Removable metal pull-out plug on left end of cabinet provides access for crystal changing. Very easy to build with complete instructions supplied. Shpg. Wt. 19 lbs.

DX-100 PHONE AND CW TRANSMITTER KIT

Well known for its high quality and fine performance the DX-100 features a built-in VFO, modulator, and power supply, complete shielding to minimize TVI, and a pi network coupling to match impedances from 50 to 600 ohms. RF output is in excess of 100 watts on phone and 120 watts on CW, for clean strong signals on all ham bands from 10 to 160 meters. Single knob bandswitching and illuminated VFO dial and meter face add real operating convenience. RF output stage uses a pair of 6146 tubes in parallel, modulated by a pair of 1625's. High quality components are used throughout, such as potted transformers, silver-plated or solid coin silver switch terminals, aluminum-heat dissipating caps on the final tubes, copper plated chassis, etc. Shpg. Wt. 107 lbs. \$50.00 deposit required on C.O.D. orders. Shipped motor freight unless otherwise specified.

DX-40 PHONE AND CW TRANSMITTER KIT

An outstanding buy in its power class the DX-40 provides both phone and CW operation on 80, 40, 20, 15, 11 and 10 meters. A single 6146 tube is used in the final amplifier stage to provide full 75 watt plate power input on CW, or controlled carrier modulation peaks up to 60 watts for phone operation. Modulator and power supplies are built in and single-knob bandswitching is combined with the pi network output circuit for complete operating convenience. Complete shielding to minimize TVI. Provision is made for three crystals. A four-position switch selects any of the three crystals or a jack for external VFO. Crystal sockets are reached through access door in rear of cabinet. High quality D'Arsonval movement panel meter. Shpg. Wt. 25 lbs.

For Real Ham Enjoyment

HEATHKIT

"MOHAWK" HAM RECEIVER KIT

Here is a ham receiver that any radio operator would be proud to own. The "Mohawk" has all the functions required for high quality communications with clear, rock-steady reception on all bands. This 15-tube receiver features double conversion with IF's at 1682 kc and 50 kc and covers all of the amateur frequencies from 160 through 10 meters on seven bands with an extra band calibrated to cover 6 and 2 meters using a converter. Receiver accommodations are provided for these converters which will be available in Heathkits soon. The "Mohawk" is specially designed for single-sideband reception with crystal controlled oscillators for upper and lower sideband selection. A completely preassembled, wired and aligned front end coil assembly assures ease of construction and top performance of the finished unit. Other features include five selectivity positions from 5 kc to 500 CPS, bridged T-notch filter for maximum heterodyne rejection, and a built-in 100 kc crystal calibrator. The set provides a 10 db signal-to-noise ratio at less than 1 microvolt input. Front panel features S meter, separate RF, IF and AF gain controls, T-notch tuning, T-notch depth, ANL, AVC, BFO, bandswitch, tuning, antenna trimmer, calibrate set, calibrate on, CW-SSB-AM, receive-standby, upper-lower sideband, selectivity, phone jack and a wide band rotating slide rule type vernier tuning dial with easy to read calibrations. Shpg. Wt. 90 lbs.

\$50.00 required on C.O.D. orders. Shipped motor freight unless otherwise specified.



HEATHKIT RX-1 \$274⁹⁵

Now in Kit Form a Top Quality Ham Band Receiver

- ★ PREWIRED AND ALIGNED FRONT END COIL ASSEMBLY.
- ★ CRYSTAL CONTROLLED OSCILLATORS FOR DRIFT-FREE RECEPTION.



HEATHKIT B-1 \$8⁹⁵

Get Proper Match Between Transmitter and Antenna

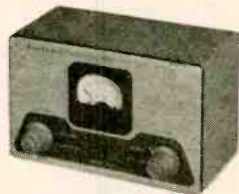

HEATHKIT AM-2 \$15⁹⁵

Measure Standing Wave Ratio



HEATHKIT VX-1 \$23⁹⁵

Eliminates Hand Switching

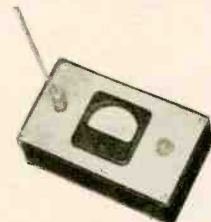

HEATHKIT PM-1 \$14⁹⁵

Quick Check of Transmitter Operation

BALUN COIL KIT

Unbalanced coax lines used on the most modern transmitters can be matched to balance lines of either 75 or 300 ohms impedance by using the model B-1 Balun Coil Kit. Can be used with transmitters and receivers without adjustment over the frequency range of 80 through 10 meters, and will handle power inputs up to 200 watts. Cabinet size is 10" square by 5" D. and may be located any distance from the transmitter or antenna. A protective cover is supplied to prevent damage in outdoor installations. Shpg. Wt. 4 lbs.

REFLECTED POWER METER KIT

The match of your antenna transmission system can be checked by measuring the forward and reflected power or standing wave ratio from 1:1 to 6:1 with this fine unit. Designed to handle a peak power of well over 1 kilowatt of energy the AM-2 may be left in the antenna system feed line at all times. Band coverage is 160 meters through 2 meters. Input and output impedances for 50 or 75 ohm lines. No external power required for operation. Cabinet size is 7 1/4" x 4 1/8" x 4 1/8". Shpg. Wt. 3 lbs.

ELECTRONIC VOICE CONTROL KIT

This unique device allows you to switch from receiver to transmitter merely by talking into your microphone . . . you get the advantage of "telephone-type conversation" as in single sideband but with regular AM transmission. The unit is adjustable to all conditions by sensitivity controls provided. A variable time delay control changes the "hold" time. Provision is made for receiver and speaker connections and also for a 117 volt antenna relay. Built-in power supply. Complete instructions provided. Shpg. Wt. 5 lbs.

RF POWER METER KIT

This self contained unit requires no power for operation. You simply place it close to the transmitter antenna to sample the RF field which is then indicated on the panel meter. Operates with any transmitter having an output frequency between 100 kc and 250 mc, regardless of power. Sensitivity is 0.3 volts RMS full scale, and a special control on the panel allows for further adjustment of the sensitivity. Measures 3 1/4" W. x 6 1/4" L. x 2" D. An easy way to put your mind at ease concerning transmitter operation. Shpg. Wt. 2 lbs.

HEATH COMPANY • a subsidiary of Daystrom, Inc. • Benton Harbor 20, Mich.



Choose from a wide variety of Heathkits

DUAL-CHASSIS 20 WATT HI-FI AMPLIFIER KIT

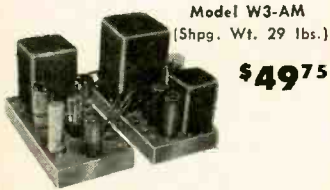

Model W3-AM
(Shpg. Wt. 29 lbs.)

\$49⁷⁵

12" UTILITY SPEAKER



Model 401-6
(Shpg. Wt. 7 lbs.)

\$7⁵⁰

ALL-BAND RADIO KIT



Model AR-3
(Shpg. Wt. 12 lbs.)

\$29⁹⁵
(less cabinet)

CRYSTAL RADIO KIT



Model CR-1
(Shpg. Wt. 3 lbs.)

\$7⁹⁵

BROADCAST BAND RADIO KIT



Model BR-2
(Shpg. Wt. 10 lbs.)

\$18⁹⁵

(less cabinet)

ELECTRONIC CROSSOVER KIT



Model XO-1
(Shpg. Wt. 6 lbs.)

\$18⁹⁵

"Q" MULTIPLIER KIT



Model QF-1
(Shpg. Wt. 3 lbs.)

\$9⁹⁵

"AUTOMATIC" CONELRAD ALARM KIT



Model CA-1
(Shpg. Wt. 4 lbs.)

\$13⁹⁵

GRID DIP METER KIT



Model GD-1B
(Shpg. Wt. 4 lbs.)

\$21⁹⁵

VIBRATOR POWER SUPPLY KIT



6 volt Model VP-1-6
12 volt Model VP-1-12
(Shpg. Wt. 4 lbs.)

\$7⁹⁵
ea.

VARIABLE FREQUENCY OSCILLATOR KIT



Model VF-1
(Shpg. Wt. 7 lbs.)

\$19⁵⁰

PROFESSIONAL RADIATION COUNTER KIT



Model RC-1
(Shpg. Wt. 8 lbs.)

\$79⁹⁵

ISOLATION TRANSFORMER KIT



Model IT-1
(Shpg. Wt. 9 lbs.)

\$16⁵⁰

ELECTRONIC SWITCH KIT



Model S-3
(Shpg. Wt. 8 lbs.)

\$21⁹⁵

REGULATED POWER SUPPLY KIT



Model PS-3
(Shpg. Wt. 17 lbs.)

\$35⁵⁰

VOLTAGE CALIBRATOR KIT



Model VC-3
(Shpg. Wt. 4 lbs.)

\$12⁵⁰

DIRECT-READING CAPACITY METER KIT



Model CM-1
(Shpg. Wt. 7 lbs.)

\$29⁵⁰

TUBE CHECKER KIT

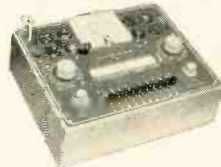

Model TC-2
(Shpg. Wt. 12 lbs.)

\$29⁵⁰

EASY TIME PAYMENTS AVAILABLE FOR YOUR CONVENIENCE . . .

Any order totaling \$90 or more can be paid for in small monthly payments (send for complete details).

RESISTANCE SUBSTITUTION BOX KIT

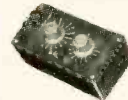

Model RS-1
(Shpg. Wt. 2 lbs.)

\$5⁵⁰

CONDENSER SUBSTITUTION BOX KIT



Model CS-1
(Shpg. Wt. 2 lbs.)

\$5⁵⁰

CATHODE RAY TUBE CHECKER KIT



Model CC-1
(Shpg. Wt. 10 lbs.)

\$24⁹⁵

LABORATORY RF GENERATOR KIT



Model LG-1
(Shpg. Wt. 16 lbs.)

\$48⁹⁵

"Q" METER KIT



Model QM-1
(Shpg. Wt. 14 lbs.)

\$44⁵⁰

DECADE CONDENSER KIT

Model DC-1
(Shpg. Wt. 3 lbs.)

\$16⁵⁰



DECADE RESISTANCE KIT

Model DR-1
(Shpg. Wt. 4 lbs.)

\$19⁵⁰

Note the improvement



You can easily make music sound richer with Centralab Compentrol®

Put Centralab Compentrol in your customers' radios and TV sets, and *presto!* Sound satisfaction! That's because this remarkable control with built-in compensating circuits provides perfect tonal balance of the highs and the lows—and does it automatically at any volume level. Unlike ordinary controls, Compentrol brings out the full richness of the sound . . . brings hi-fi into any living room.

Compentrol is easy to install in any radio, TV, or hi-fi set. You merely replace the existing control . . . no circuit changes required.

FREE: A booklet describing in detail how the Compentrol works and how easy it is to install. Write directly to Centralab for your copy.

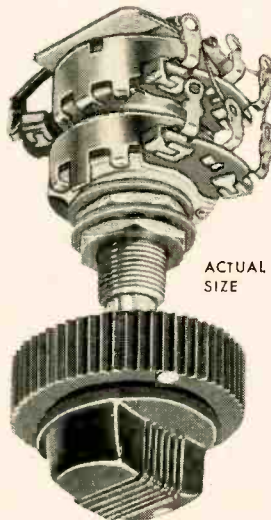

6 MODELS AVAILABLE—Replace standard volume controls without rebuilding. Fit all hi-fi's, record players, radios, TV, pre-amplifiers, amplifiers, tuners, and tape recorders.

TELEVISION

(Continued from page 61)
frequencies. More will be said concerning F2 television reception in the November FM-TV Dx column. (See "Looking In on London," page 52, this issue.)

Report forms

During the past few months, the TV Dx column has received numerous letters, "I read about TV and FM dx in your column, and thought that I would give it a try. Much to my surprise, I logged . . ." Undoubtedly, many readers are keeping a half-cocked eye on the FM or TV scene for some signs of distant reception, although not considering themselves full-fledged dxers. In FM and TV dx reception, it is not quantity, but quality which counts.

In short, we would like to have a report from you, no matter how small or seemingly insignificant. Write for a set of report forms today, and get into the swing of dx reporting. Simply address a postcard to RADIO-ELECTRONICS, TV Dx Column, 154 W. 14 St., New York 11, N.Y. with your name and address firmly and clearly on the back. END

Defective Socket

One evening I was called to repair a Trav-Ler which had no picture. The first tube replaced was a 6SN7 horizontal oscillator and the picture immediately returned. Satisfied the trouble was located, I made the customary checks and departed. In approximately a week this customer reported the picture was again gone. I replaced the same 6SN7 and the picture returned.

The customer was assured that even new tubes sometimes are defective and again I departed confident the trouble was remedied. Within two weeks the customer reported that by turning the set on and leaving it on for an hour or so it would eventually have a picture. For the third time I replaced the 6SN7. This time I pushed the tube down into the socket and watched it. A few seconds later it popped up! I pushed the tube well down into the socket at least five times, and each time it eased back up. This accounted for the delayed operation, for eventually due to vibration the tube lost contact as it rested on top of the socket. I've seen many loose tube sockets, but these were simply repulsive.

—P. J. Hogan

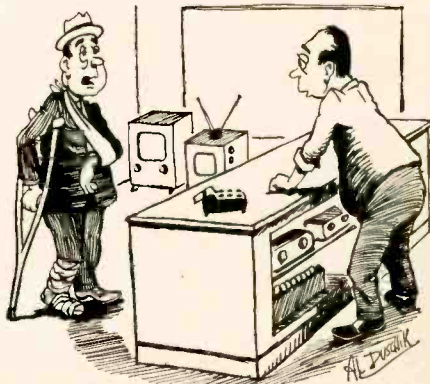

"What do you charge to install an antenna on a steep roof?"

Centralab

A DIVISION OF GLOBE-UNION INC.
922J EAST KEEFE AVENUE • MILWAUKEE 1, WISCONSIN
IN CANADA: 804 MT. PLEASANT ROAD • TORONTO, ONTARIO

B-5839

ROHN Designs Amazing No. 25 Tower to reach new heights in tower engineering

NEW GENERAL-PURPOSE COMMUNICATION OR HEAVY-DUTY TV TOWER

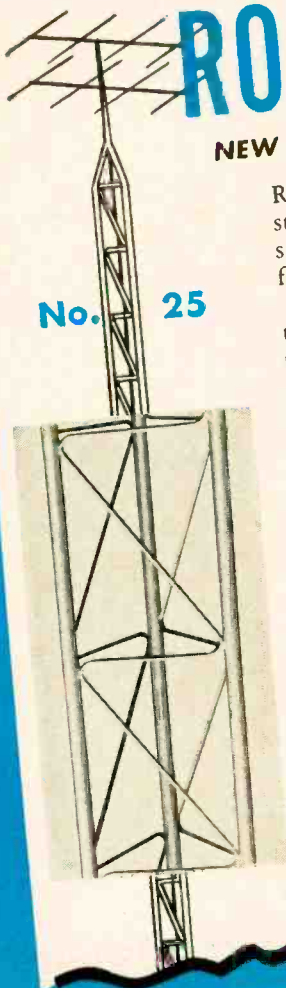

No. 25

ROHN now offers a tower a full 33% stronger and more durable than similar sized and similar type towers that are found on the market today!

These amazing results are achieved through using heavier-duty side rail tubing, quality steel that is of the highest grade and a new "zig-zag" cross bracing design.

The strength of this tower allows it to be self-supporting under most condi-

tions to 50' and under guyed conditions up to 150'. The tower has been built to fit a tremendously wide range of needs in communications, amateur use and as a heavy-duty TV tower.

FLASH! The "RohnKote" enameling plant is in operation and ROHN products are available not only in **HOT-DIPPED GALVANIZING** but also in a specially developed 6-step enameling process known as "RohnKote".

NOW! 10 Different Lines of ROHN TOWERS, Including:

No. 6

Widely used for home TV, this tower features "magic triangle" cross bracing construction.

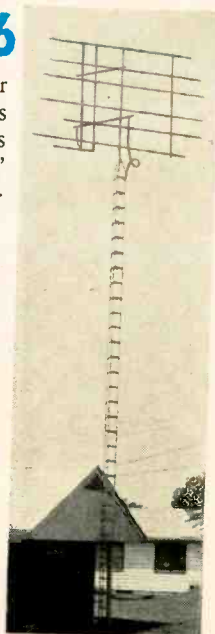

Packaged Towers in which the sections nestle inside each other.

No. 40

Heavy-duty communications tower suitable self-supporting at heights up to 60' or guyed as high as 300'. Ideal for communications uses of all types, microwave, radio telephone, etc.

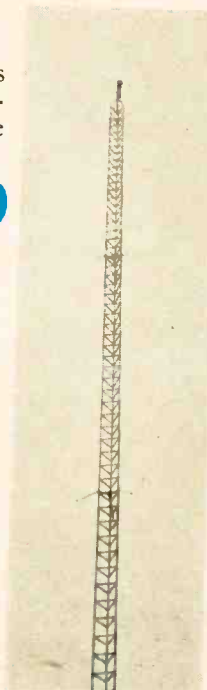

No. 20 & 30

Heavy-duty communications towers in RohnKote enamel.

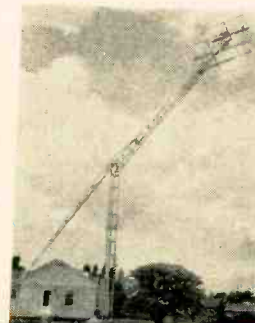

Fold-Over Towers

Ideal for amateurs and experimenters inasmuch as the tower folds over for convenient antenna changing, etc. Supplied in both medium and heavy-duty sizes to handle practically any size beam.

Look to ROHN for these requirements, too:

A wide line of all types of accessories for towers is available but in addition, ROHN produces a complete line of:

MASTS

ROHN masts are outstanding in design and have special features that make them the best in the field and in addition, are as low or lower in cost than any other.

TUBING

Complete line of tubing, either plain or with 6" expanded end; in 10' and 5' length; 16 or 18 gauge; and in either hot-dipped galvanized or "RohnKote" enameling.

ROOF TOWERS

Specially designed roof towers have received tremendously wide acceptance and are available from heights of 2½' to 10'.

BASES

A wide selection for mast and other type installations; wall mounts—for inexpensive installations; gable mounts; special mounts for antennas; drive-in ground mounts; and dozens of other specially designed items.

Make sure you have full details, catalog and prices on the entire ROHN line. Contact the ROHN representative in your area, or distributor, or contact:

ROHN Manufacturing Company

116 LIMESTONE, BELLEVUE

PEORIA, ILLINOIS

PHONE 4-9156

what's

new

?

MAGNETIC PAGE RECORDER-READER works like a tape recorder, except that the record-playback heads move instead of the recorded material. Developed by Prof. Yasushi Hoshino of Tokyo Institute of Technology, the Synchronreader accommodates page-sized sheets of paper, coated on one side with an iron oxide material. The other side can contain written or printed matter. Each sheet is scanned by three revolving heads on a traveling turntable, moving from left to right and top to bottom. The page recordings can be fully scanned or selected portions located and played. The manufacturer, Canon Camera Co. of Tokyo, suggests the device can be used to read "talking magazines" (as above) or letters. A Japanese trade publication speculates: "Supposing you get a letter from your sweetheart, you can listen to her voice while you are reading the letter."

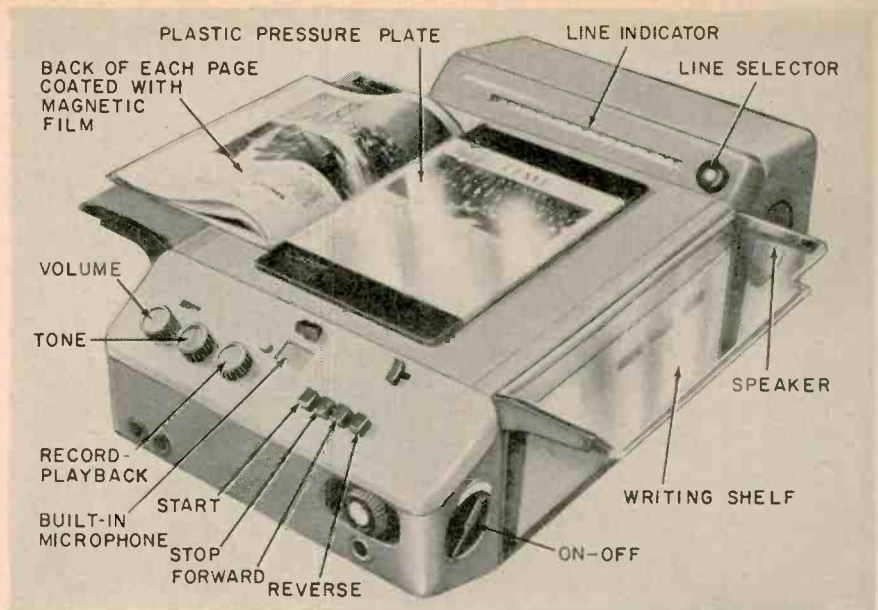

NEW SHAPE IN TUBES, the "match-box" envelope, has been developed for military use by Westinghouse Electric Corporation. Since it uses the same electrode structure as conventional receiving tubes, the design can be applied to an entire line of tubes. Made of Pyroceram heat-resistant ceramic, its advantages are dimensional accuracy, elimination of possibility of loose particles and gas, adaptability to recessing or strapping to printed-circuit boards and high resistance to vibration.

BIGGEST OVAL SPEAKER is this 9 x 21-inch unit shown with 4-inch, 4 x 6-inch and 8-inch speakers often found in today's TV receivers. It is used in new General Electric television sets. The big oval works in conjunction with the 4-inch tweeter (held in hand) to reproduce 40 to 10,000 cycles.

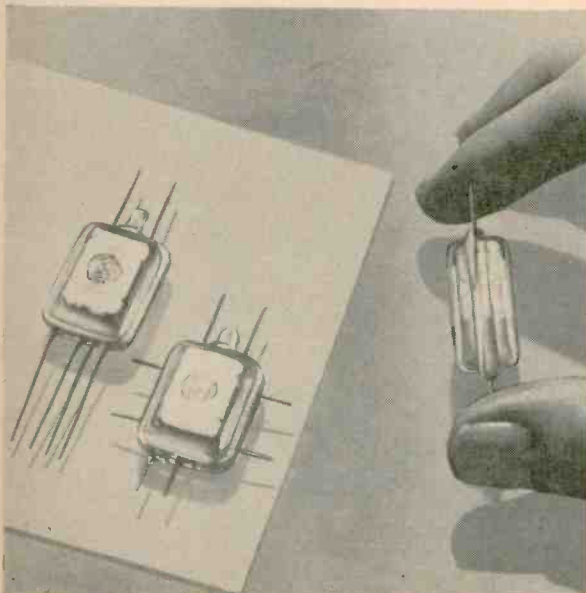

NOW IT'S 8 1/3 RPM — but not for home music systems. This is a laboratory model of a new "talking-book" phonograph for the blind developed by Dr. Peter Goldmark of CBS Laboratories for the Library of Congress, which plans to replace the 45,000 33 1/3-rpm talking-book phonos now in use with the new speed within a few years. Since its frequency range is only 100-5,000 cycles, Dr. Goldmark sees no general commercial applications for the 8 1/3-rpm records. Their principal advantage is economy; a 7-inch disc will play for 2 hours on each side, costing one-tenth the amount of the equivalent material on 33 1/3-rpm records and saving \$300,000 a year in shipping costs alone.



PERCHING THE TUBE ATOP THE SET seems to be the new trend in avant-garde television receiver design. This set, a Teleavia console made by Societe Francaise Frigeavia, Paris, uses the same bold approach to TV design as the American and Italian tube-atop-set models shown on page 77 in last month's Radio-Electronics. In this model, the tube assembly may be swiveled 180°, and tilted upward or downward by means of the adjustment knob below the tube housing. The top of the tube housing and the top rear panel of the chassis housing are removable for servicing.

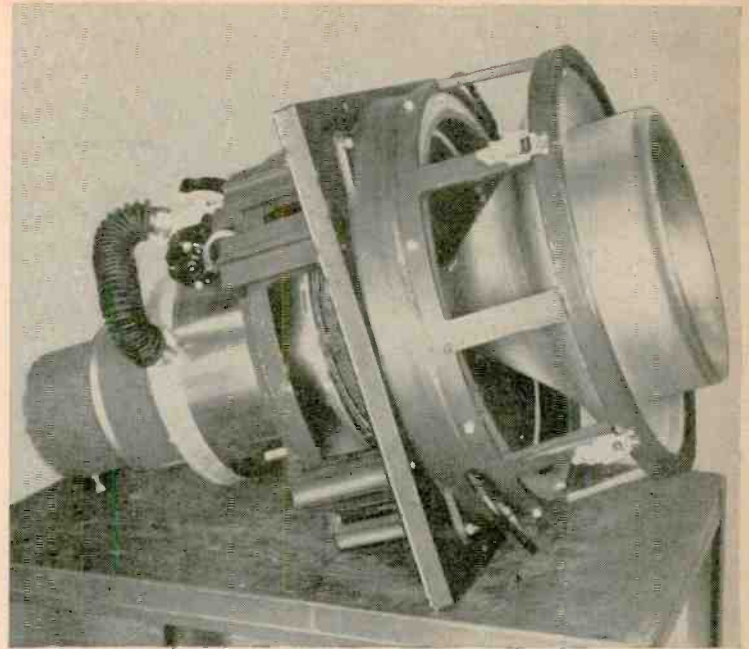

WANT LOTS OF VOLUME? Try this 1,000-watter in your hi fi. Actually, this 150-pound speaker was built by Stromberg-Carlson for the Convair acoustical laboratory's research into the effects of high-intensity noise on missiles and jet planes. Its woofer is driven by a 24½-pound Alnico V ring magnet with a total air-gap flux of 696,000 maxwells, and produces sounds up to 300 cycles. The cone vibrates as much as 2 inches. Because of its high power dissipation, the voice coil is cooled by a powerful fan. An acoustic compression driver and coaxial horn supply sounds from 300 to 2,400 cycles. Though they won't be used in the Convair installation, Stromberg-Carlson has designed a ring of 13 tweeters to surround the mid-range horn and extend the range to 15,000 cycles.

MORE SENSITIVE THAN THE EYE, 100 times more sensitive to light than the fastest photographic film for the same exposure time at low light-level, this Intensifier Orthicon, which can "see" in surroundings which appear totally dark, may find important uses in astronomy, military reconnaissance and scientific research. Developed by Dr. George A. Morton (left) and Dr. John E. Ruedy of RCA's David Sarnoff Research Center, the developmental tube is based on the Image Orthicon TV camera tube, but permits viewing of TV-like images of scenes with light levels from 100 to 1,000 times below those required by an Image Orthicon. Inside the tube is an "intensifier screen" which emits 10-20 electrons for every one that strikes it. With two such screens, about 300 electrons are produced for every one released by the image on the tube's sensitive surface.



KEY TO ATOMIC POWER may be held by the tiny high-vacuum thermionic converter developed by scientists of the General Electric Research Laboratory. A combination of metal and ceramic discs surrounding a vacuum, this working model produces electricity directly from heat. Although voltage and current produced by this model are low, G-E scientists estimate that converters this size will be capable of operating in the 1-10-watt range. In such a converter, two electrodes are held at high, but different temperatures. Electrons are "boiled out" of the hotter cathode and are collected by the relatively cool anode. An earlier thermionic converter, a foot-long gas-filled tube, was announced by G-E last year.



an ELECTRONIC ANEMOMETER

By IRVING M. GOTTLIEB

A clock motor, transistor dc amplifier, and milliammeter are the principal parts of this simple wind-speed indicator

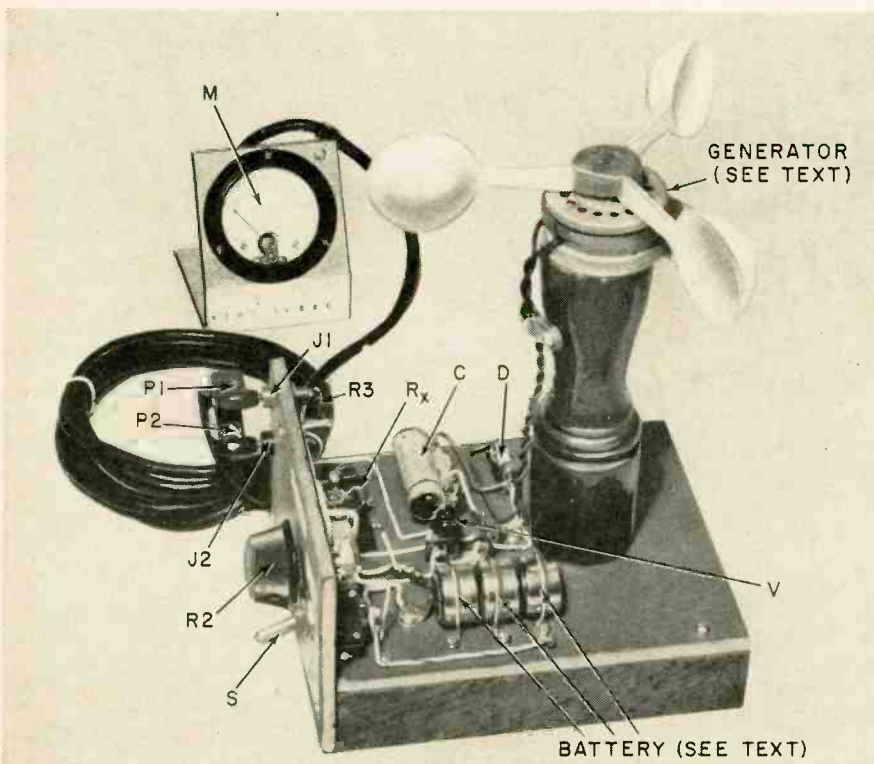

The finished unit with remote speed indicator. Note that the wind cups are mounted well clear of the chassis.

FOR a number of hobbies and activities, a way to measure wind speed is useful. The wind-speed indicator described here can be used at model-airplane meets, small airports and boat houses and by amateur meteorologists. It can also be used anywhere wind speed must be monitored—smog and air-pollution investigation, for example.

The indicator unit is made up of an ac generator, an anemometer wind element, a transistor current amplifier and an indicating meter. The operating principle is simple. As shown in Fig. 1, the ac output from the generator is rectified by diode D, and the resulting dc is applied to the base of transistor V. The transistor's output, connected across meter M, gives a reading proportional

to the speed of the wind turning the generator. Stronger winds give higher readings.

An electric clock motor is used for the ac generator. I tried several motors and, while there are variations in their outputs, almost any one may be used. As the transistor amplifier provides plenty of gain, even with low-output units, it is best to select the motor with the lowest friction—it will turn at lower wind speeds. Clock motors can often be purchased from surplus houses at very low cost.

After you have selected a motor, connect it to an oscilloscope and manually spin the motor shaft or disc (not the low-rpm output shaft). Spin the motor in both directions and note which

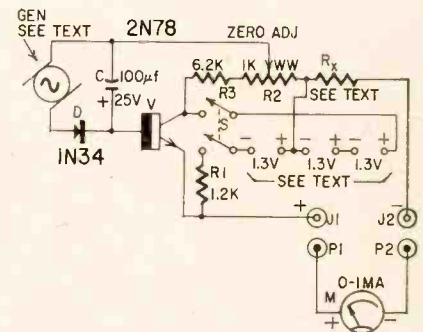

- R1—1,200 ohms, 1/2 watt, 10%
- R2—pot, 1,000 ohms, wirewound
- R3—6,200 ohms, 1/2 watt, 10%
- C—100 µf, 25 volts
- D—1N34
- J1, 2-tip jacks
- M—0-1 ma, dc meter
- P1, 2-tip plugs
- S—dpst toggle
- V—2N78 (G-E)
- Battery, 4-volt mercury (Mallory TR-233R or equivalent) (this battery consists of three series-connected cells)
- Generator, electric clock motor (see text)
- Plastic tablespoons (3)
- Miscellaneous hardware

Fig. 1—Circuit of the easily constructed wind-speed indicator.

generates the highest output. This determines whether a clockwise or counterclockwise wind element is needed. The motor I used turned out to be more efficient when turned counterclockwise.

Assemble the wind cups

The next step is to build the wind cups. These are made of three stiff

NEW CATALOG

from the

NEW RADIO SHACK

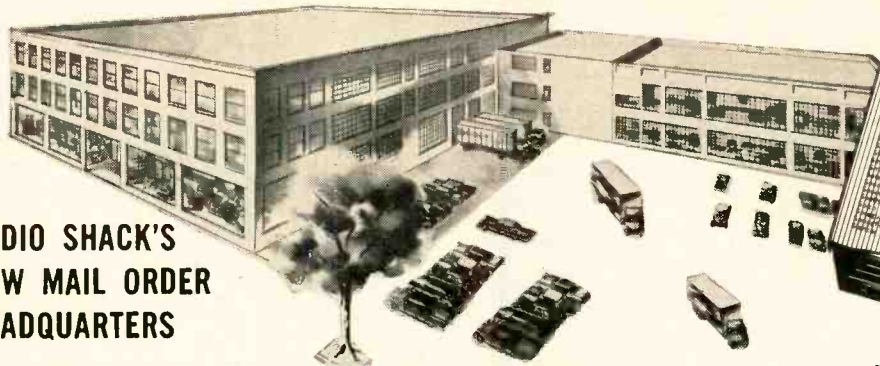

**RADIO SHACK'S
NEW MAIL ORDER
HEADQUARTERS**

WE HAVE MOVED! — Seven warehouses, our executive and mail-order and industrial sales forces have moved to this vast building at 730 Commonwealth Avenue in Boston, adding — in addition — a second big Boston store! No expense has been spared to give us and you the most accurate and FASTEST SERVICE in the entire country!

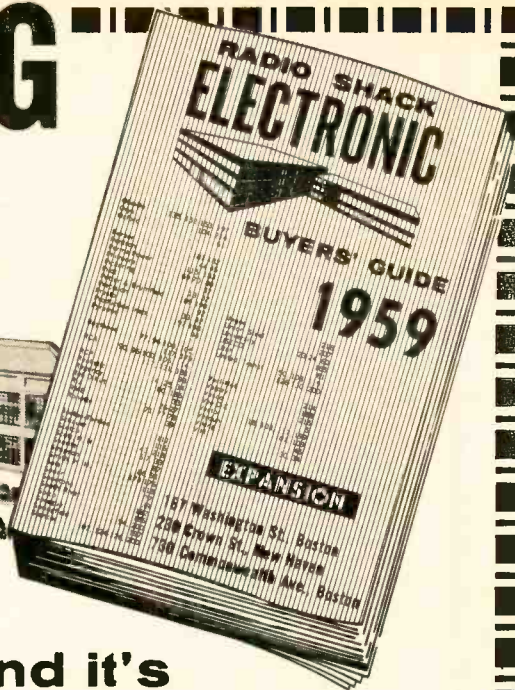

and it's
absolutely

FREE!

232 Pages FULL of
Vital Listings for:

- High Fidelity
- Schools — Labs • Experimenters
- Hobbyists • Servicemen
- Amateurs • Industrials

EASY TO USE!

- Comprehensive Product Index
- Complete Manufacturers Index
- Handy Thumb Index

EXPANSION SALE

STEREO-READY HI-FI BARGAIN

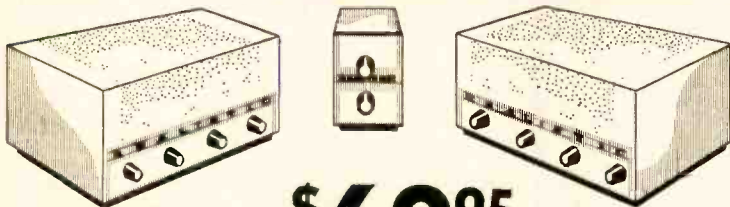

24 Watts Monaural
12 Watts Stereo

\$69⁹⁵

Value \$119.85

YES! FOR JUST \$69.95 you get all three Realistic hi-fi products . . . a matched pair of new Realistic 12-watt amplifiers plus hi-fi's brilliant new "go-between" — the Realistic Stereo Master. Each 12 watt amplifier is complete with maroon and gold cage, preamp, separate tone controls, 5 tubes, 20-20,000 cps ± 1 db @ 12 watts. Thus you get a walloping 24 watt output in monaural or a smooth 12 watts in stereo! Each amplifier is pre-wired for simple screw connection to the Stereo Master. And the Stereo Master was custom designed by Radio Shack for this amplifier. Features of the Stereo Master control unit include: master volume control, mode switch for normal and reverse stereo and right-left or left-right monaural, plus slide switch for parallel monaural output.

Order No. R-7243AF-12, Ship. wt. 24 lbs. Complete \$69.95

BIGGEST AMPLIFIER VALUE — EVER!

REGULARLY \$49.95, the fabulous new Realistic 12 watt hi-fi amplifier (see above) includes stunning gold and maroon case, 20-20,000 cps @ 12W, 5 tubes, over-size AC and output transformers, RIAA preamp, bass and treble controls, 4/8/16-ohm taps. And it's ready for stereo via stereo terminal strip on rear panel!

\$29⁹⁵

Order No. 33CX303Y, Ship. wt. 12 lbs. \$29.95

RADIO SHACK CORP.
Stores:
730 COMMONWEALTH AVENUE • BOSTON 17, MASS.
167 WASHINGTON STREET • BOSTON 3, MASSACHUSETTS
230-240 CROWN STREET • NEW HAVEN 10, CONNECTICUT

MAIL ORDERS } **RADIO SHACK** Dept. 9F
TO: } 730 COMMONWEALTH AVENUE, BOSTON 16

- Please Send FREE 232 pg. 1959 Catalog
 - 2 12 Watt Amplifiers plus
1 Stereo Master 33-303-2F, R-7243 \$69.95
 - 12 Watt Amplifier 33-303F \$29.95
- \$ Check or M.O. Enc.

Name:

Address:

City: Zone: State:

TRY THESE PHOTOCELL CIRCUITS

Three ways you can use the sensitive CdS unit

By EDWIN BOHR

SENSATIONAL is the only word to describe the characteristics of the cadmium sulfide (CdS) crystal photocell. Few cells match its sensitivity, ruggedness, long life, small size and low cost.

These photocells are *photoconductive* and require somewhat different circuitry than do other types. However, the circuits are simple. In many applications the cell output is enough to operate a sensitive relay without amplification.

Tubeless relay

Probably the simplest application of a crystal photocell is shown in Fig. 1. The cell is connected in series with a sensitive relay and dc power supply. Resistor R1 reduces the sensitivity, but protects the cell from excessive current flow at high light levels.

Like any resistor, the cell has a maximum dissipation rating, which depends upon the crystal's ability to get rid of heat. A copper backing plate, used in special cell designs, produces very high dissipation ratings. However, existing cells are rated in milliwatts. For example, the Clairex CL-2 is rated at 50 mw.

The value of the protective resistance is based on the dissipation rating of the crystal and the voltage developed across it at power match, which is one-half the supply voltage. The formula then is simply $R = (\frac{1}{2}E)^2/W$, where E is the supply voltage and the crystal

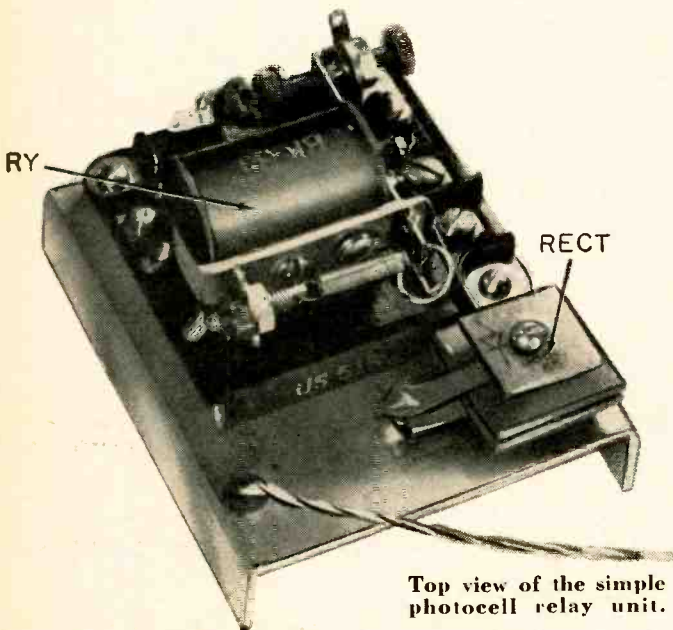

Top view of the simple photocell relay unit.

3-LUG TERM STRIP

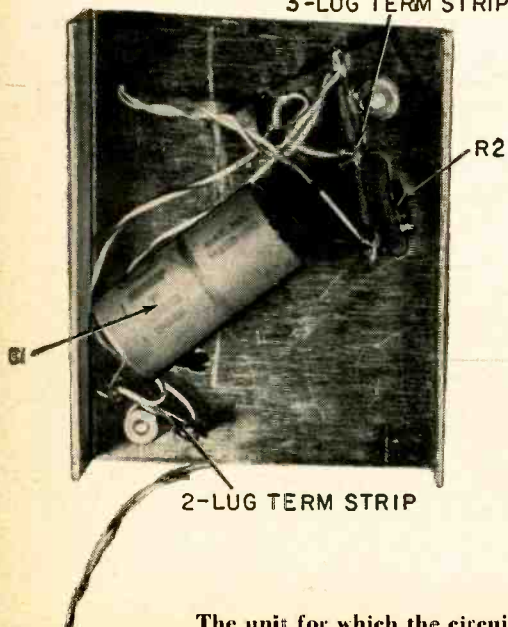

Under the chassis. Note the use of terminal strips.

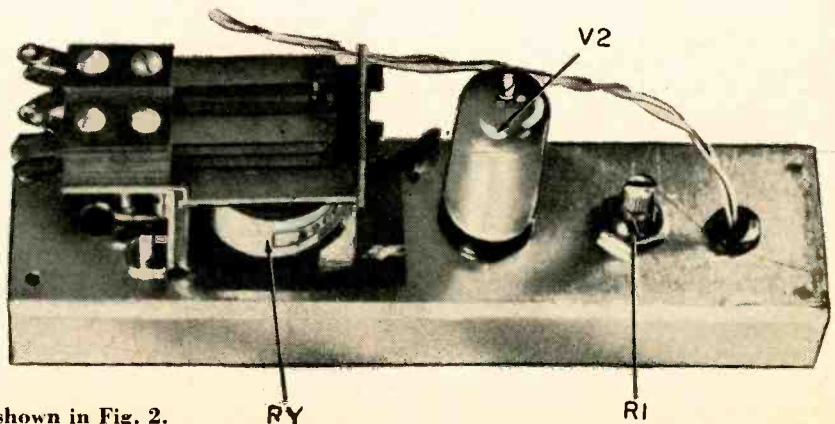

The unit for which the circuit is shown in Fig. 2.

Now! **PHOTOFACT** Helps You Lick Printed Board Troubles in Seconds!

exclusive new Sams **CIRCUITRACE*** feature eliminates costly hunting for test points...no more maze to trace...no need to flip-flop board...makes printed board servicing fast and easy

HERE'S HOW **CIRCUITRACE*** WORKS FOR YOU:

1 All test points are clearly shown on the schematic and each is plainly coded...

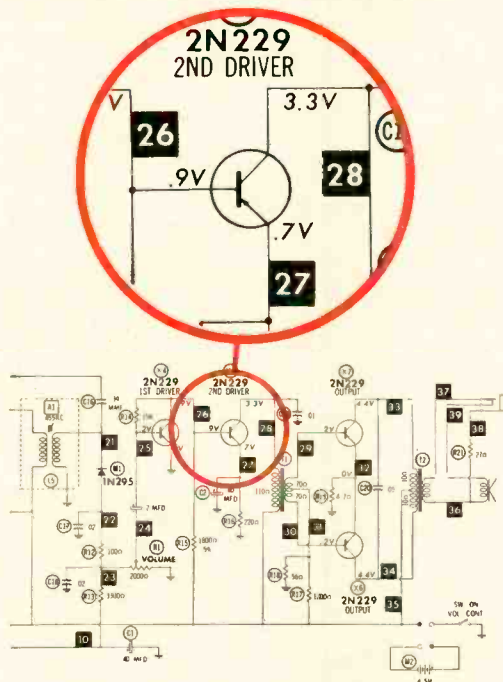

2 The test points are similarly coded on the printed board so you instantly know where to apply the test!

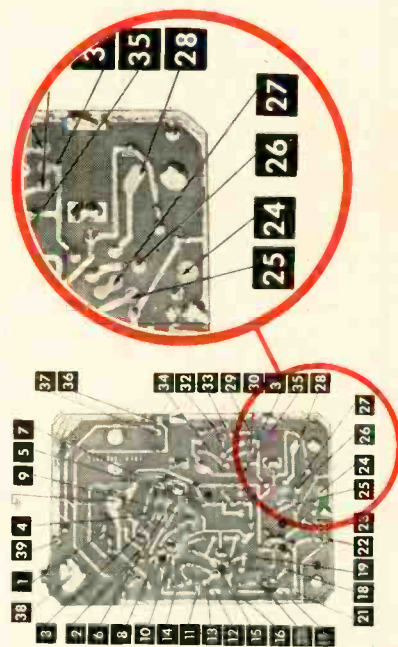

EXCLUSIVE CIRCUITRACE* IS NOW A REGULAR FEATURE IN **PHOTOFACT**

Write for Free PHOTOFACT Folder showing actual application of the CircuitTrace system. See for yourself how PHOTOFACT makes you an expert on printed board servicing—enables you to earn more by giving you exclusive time-saving help like this.

NOW—MORE THAN EVER

YOU need PHOTOFACT! It's the best way to keep up with servicing trends, to maintain your position of leadership, to insure and build your earning power. Be a regular monthly subscriber to PHOTOFACT. Sign up with your Distributor.

subscribe to PHOTOFACT today...

HOWARD W. SAM & CO., INC.
2205 E. 46th Street, Indianapolis 5, Ind.

- Send FREE PHOTOFACT Folder showing CircuitTrace
- I am interested in a regular subscription to PHOTOFACT

My Distributor is: _____

Name _____

Address _____

City _____ Zone _____ State _____

**SMALL
ENOUGH TO FIT
INTO THE
SMALLEST
POCKET PORTABLE**

40K

**WITH ENOUGH
POWER FOR THE
BIGGEST
COLOR TELEVISION
RECEIVER**

Tarzian

SERIES

Silicon Rectifiers

- ✓ **COMPACT**—no special holder required . . . supported by pigtail leads
- ✓ **PROVED-PERFORMANCE**—in all electronic applications
- ✓ **ECONOMICAL**—Tarzian's mass production means lower cost to you
- ✓ **PACKAGED** for your convenience in pocket-size "5 Paks".



Send for data sheets.

SPECIFICATIONS

	40K	K-200
MAX. AC INPUT VOLTAGE	130	130
MAX. PEAK INVERSE VOLTAGE	400	360
MAX. PEAK CURRENT (MA)	7500	2000
MAX. DC CURRENT (MA)	750	200
APPROX. RECTIFIER VOLTAGE DROP	2	2
MAX. OPERATING TEMP.	100°C	100°C
MAX. SURGE CURRENT (AMPS)	30	20
MIN. SURGE LIMITING RESIS. (OHMS)	7.5	10

DIMENSIONS

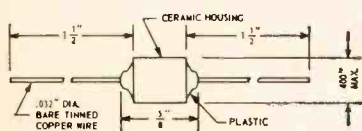

Sarkes Tarzian, Inc.

DEPT. R-5
RECTIFIER DIVISION, 415 N. COLLEGE AVE.
BLOOMINGTON, INDIANA

IN CANADA: 700 WESTON RD., TORONTO 9, TEL. ROGERS 2-7535
EXPORT: AD AURIEMA, INC., NEW YORK CITY

ELECTRONICS

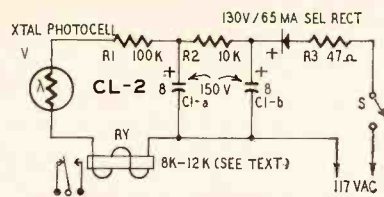

R1—100,000 ohms
R2—10,000 ohms
R3—47 ohms
All resistors 1/2 watt
C1—8-8 μf, 150 volts, electrolytic
RECT—selenium, 130 volts, 65 ma
RY—8,000-12,000-ohm coil (Sigma 4F-8000, BK-35, Advance 850 or equivalent)
S—spst
V—CL-2 (Clairax or equivalent)
Terminal strip (2 lugs)
Terminal strip (3 lugs)
Chassis, to suit
Miscellaneous hardware

Fig. 1—Simple circuit uses a minimum of parts. R1 is placed in the lead to the photocell and covered with spaghetti, and does not appear in the photo.

rating is W in watts. As a rule of thumb, for the 50-milliwatt crystal, use a minimum of 50,000 ohms per hundred volts of supply. The resistance of the relay coil can, of course, be considered as part of the protective resistance.

Now let's see how the circuit acts with a typical photocell and relay. Using a CL-2 cell, 100,000 ohms for R1, and a relay adjusted to close at 1 ma, less than 1 foot-candle keys the relay.

Any relay that operates on 1 ma is suitable for use with the CL-2. Higher illumination does not yield appreciably greater currents because of the cushioning effect of R1.

A few suitable relays are the Sigma 4F, BK-35 (surplus) and the Advance 850 with a 10,000-ohm coil. These relays have fairly delicate contacts usually not suitable for operating motors or heavy loads from incandescent lights. But you can use them to operate a power relay.

For running the circuit at higher light levels (and consequently lower cell resistances) simply reduce the supply voltages and circuit resistances. A few minutes experimenting with a milliammeter in place of the relay will indicate the correct values for a given set of light conditions. For this as well as the circuit in Fig. 2, be sure to make all line-return connections to terminal strips isolated from the chassis (see

photos). This will prevent hot-chassis possibilities.

Cold-cathode relay

Fig. 2 features a wide span of adjustment and the trigger threshold can be set for high as well as low light levels. The control tube is a miniature seven-pin unit similar in many respects to the older 9A4-G.

Raising the starter-electrode (pin-4) voltage past a critical point initiates a discharge to the cathode that transfers to the anode. The glow discharge is extinguished each time the ac supply goes through zero.

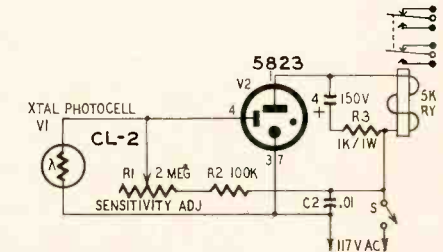

R1—pot, 2 megohms
R2—100,000 ohms
R3—1,000 ohms
All resistors 1/2 watt
C1—4 μf, 150 volts, electrolytic
C2—.01 μf, 600 volts
RY—5,000-ohm coil (Guardian 200-5000D or equivalent)
S—spst
V1—CL-2 (Clairax or equivalent)
V2—5823
Socket, 7-pin miniature
Chassis, to suit
Miscellaneous hardware

Fig. 2—Use of a cold-cathode tube and a sensitivity control increases the circuit's versatility.

The starter electrode is fed from a voltage divider across the ac line. One leg of this divider contains the CdS cell. A decreasing light level raises the starter electrode to the striking potential, activating the plate relay.

A small electrolytic capacitor (C1) is placed across the relay to smooth the rectified ac and prevent the relay from buzzing. In series with this capacitor is a 1,000-ohm resistor which limits charging current to the 100-ma rating of the 5823.

Almost any 5,000- or 10,000-ohm plate relay is satisfactory for this circuit. The circuit shown in the photograph used a Guardian series 200 relay with a 5,000-ohm plate coil. However, the large magnetic gap and high con-

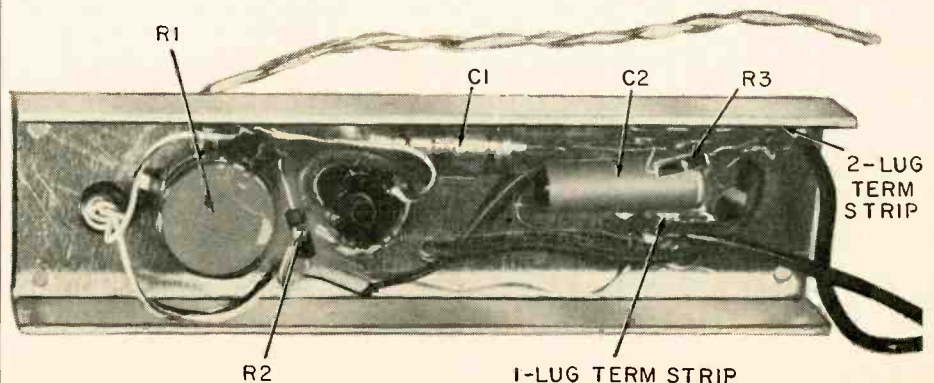

Underchassis of the cold-cathode relay circuit. Again note the use of terminal strips.

R and D Labs
 Engineers...
 Servicemen...
 Hobbyists...



NEW Belden

WORKBENCH HOOK-UP WIRE DISPENSER KITS

Belden Dispenser Kits solve the problems of waste and inconvenience for all users of Hook-Up Wire and are available in the 14 most popular assortments of Vinyl, Vinyl-Nylon, Textile, and Teflon* insulated wire for every requirement.

Each kit contains an assortment of Hook-Up Wire colors and types plus a portable metal dispenser rack for workbench or wall mounting. The dispenser rack provides a complete, compact, and convenient wire department for every working area of the user's finger tips, simplifies user Hook-Up Wire stack maintenance, and helps keep wire clean and orderly while keeping the workbench neat and efficient. Available at all Belden jobbers.

* DuPont trademark

One Wire Source for Everything Electrical and Electronic

Magnet Wire • Lead Wire • Power Supply Cords,
 Cord Sets and Portable Cord • Aircraft Wires
 Electrical Household Cords • Electronic Wires
 Welding Cable • Automotive Wire and Cable



08A01G8

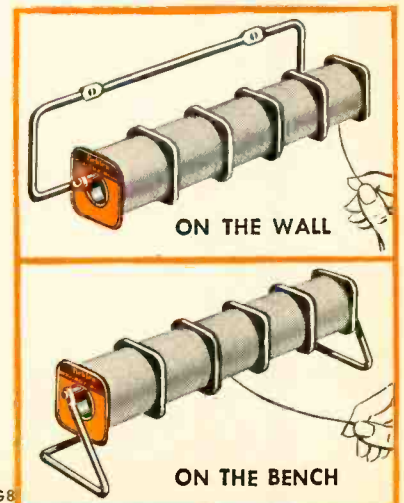

Another Britener First!

Any Set-Any Tube
UNIVERSAL

Series or Parallel
C-BRITE

Grid Defects
RESTORER

For All Defects
RESTORER

110° Shell Base
C-BRITE

3 Con King
COLOR BRITE

Lowest Cost - Parallel
VU-BRITE

Lowest Cost - Series
VU-BRITE

110° Button Base
C-BRITE

110°

by the LEADER
Perma-Power

Designed by engineers for quality, low cost, small size. Attractively packaged for quick, easy selling... consistently profitable.

The Perma-Power TV Tube Britener design is original and unique. It is fully protected by U.S. Patent No. 2,757,316.

Perma-Power COMPANY
3100 N. ELSTON AVE. CHICAGO 18, ILL.
Manufacturers of Electronic Equipment Since 1928

Can you think . . .
faster than this Machine?

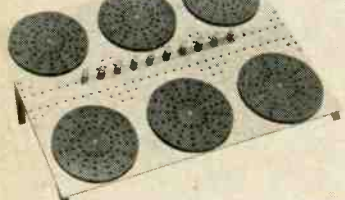

Control Panel of GENIAC set up to do a problem in check valve research.

Be careful before you answer. GENIAC® the first electrical brain construction kit is equipped to play tic-tac-toe, cipher and encipher codes, convert from binary to decimal, reason (in syllogisms) as well as add, subtract, multiply and divide. Specific problems in a variety of fields—retentional, policy claim settlement, physics, etc., can be set up and solved with the components. Connections are solderless and are completely explained with templates in the manual. This covers 125 circuits and shows how new ones can be designed.

You will find building and using GENIAC® a wonderful experience: one kit user wrote us: "This kit has opened up a new world of thinking for me." You actually see how computing, problem solving, and game play (tic-tac-toe, etc.) can be analyzed with Boolean Algebra and the algebraic solutions transformed directly into circuit diagrams. You create from over 400 specially designed and manufactured components a machine that solves problems faster than you can express them.

Schools and colleges, teachers of science or math, engineering, philosophy or psychology will find these excellent demonstrators of circuitry, solutions in symbolic logic, theory of numbers, cybernetics, and automation.

Note: Teachers take advantage of our 10% discount to educational institutions and for group purchases.

SEND for your GENIAC® kit now. Only \$19.95 with over four hundred components and parts, fully illustrated manual and wiring diagrams. We guarantee that if you do not want to keep GENIAC® after one week you can return it for full refund.

-----MAIL THIS COUPON-----

SCIENCE KITS, Dept. RE-98, Oliver Garfield Co.

108 East 16th Street, New York 3, N.Y.

Please send me:

1 GENIAC Electric Brain Construction Kit and Manual.

\$19.95 (East of Mississippi)

\$20.95 (Elsewhere in United States)

\$21.95 (Outside the United States)

Returnable in seven days for full refund if not satisfied.

I enclose \$..... in full payment.

My name and address are attached.

ALL SERVICE DEALERS LOOK TO

DēRO

SELECT-O-SWITCH
4-WAY SELECTOR SWITCH
Use as antenna switch or as a hi-fi speaker switch. Permits channelling one input to any one of 4 outputs.
model SS4 LIST \$3.25

Switch-in-Base
DUO-JUVENATOR
Parallel and Series TV tube booster. Cures 95% of all CRT failures. One-piece construction.
model RPS2 LIST \$2.95

TELE-LINK
2-SET TV & FM COUPLER
Matched transformers for peak performance on 2 TV or FM sets from one antenna.
model TL2 LIST \$2.95

134 MASSAU ROAD, ROOSEVELT, N.Y.

ELECTRONICS

tact pressure of this particular type made it necessary to stretch the contact spring to reduce flutter at marginal operation. Contact assemblies for these relays handle up to 12-amperes per contact—enough for all but the heaviest loads.

The 5823 tube is usually listed as a special-purpose or industrial type and may not be stocked by the local jobber. Nevertheless, it is available from several mail-order houses for about \$1.50.

2D21 relay

Unlike the preceding circuits, this one (Fig. 3) is isolated from the power line by a transformer. In principle, except for the differences in tubes, the circuit is similar to Fig. 2 and the same comments apply. It does, however, require heater power and a few extra components.

By changing the connection from A to B (or inserting S1 as shown in Fig. 3), either increasing- or decreasing-

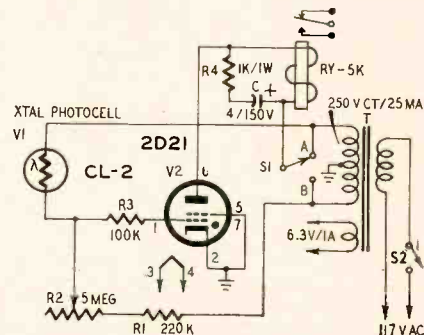

- R1—220,000 ohms
- R2—pot, 5 megohms
- R3—100,000 ohms
- R4—1,000 ohms, 1 watt
- All resistors 1/2 watt unless noted
- C—4 μf, 150 volts, electrolytic
- RY—5,000-ohm coil (Guardian 200-5000D or equivalent)
- S1—spdt
- S2—spst
- T—power transformer: primary, 117 volts; secondary, 250 volts, 25 ma, ct; 6.3 volts, 1 amp (Stancor PS-8416 or equivalent)
- VI—CL-2 (Clairess or equivalent)
- V2—2D21 (see text)
- Socket, 7-pin miniature
- Terminal strip (2 lugs)
- Terminal strip (1 lug)
- Chassis, to suit
- Miscellaneous hardware

Fig. 3—Transformer-powered unit can be triggered by an increase or decrease in light.

light operation can be selected. This connection changes the phase of the ac applied to the 2D21's plate.

The smooth operation and isolation from the line lead me to suggest this 2D21 unit as a *universal* relay for the crystal cell. It is suitable for all but the most specialized applications.

Illuminating the cell

The crystal photocell's active area is not too much larger than the period at the end of this sentence. The total amount of light received by a cell without a lens system is very small. However, the great sensitivity of the cell makes a lens or parabolic-reflector light-gathering system unnecessary except for light levels below about a 1/2 foot-candle. A lens system would be necessary, for example, only for devices such



RCA INSTITUTES



OFFERS YOU THE FINEST OF HOME STUDY TRAINING

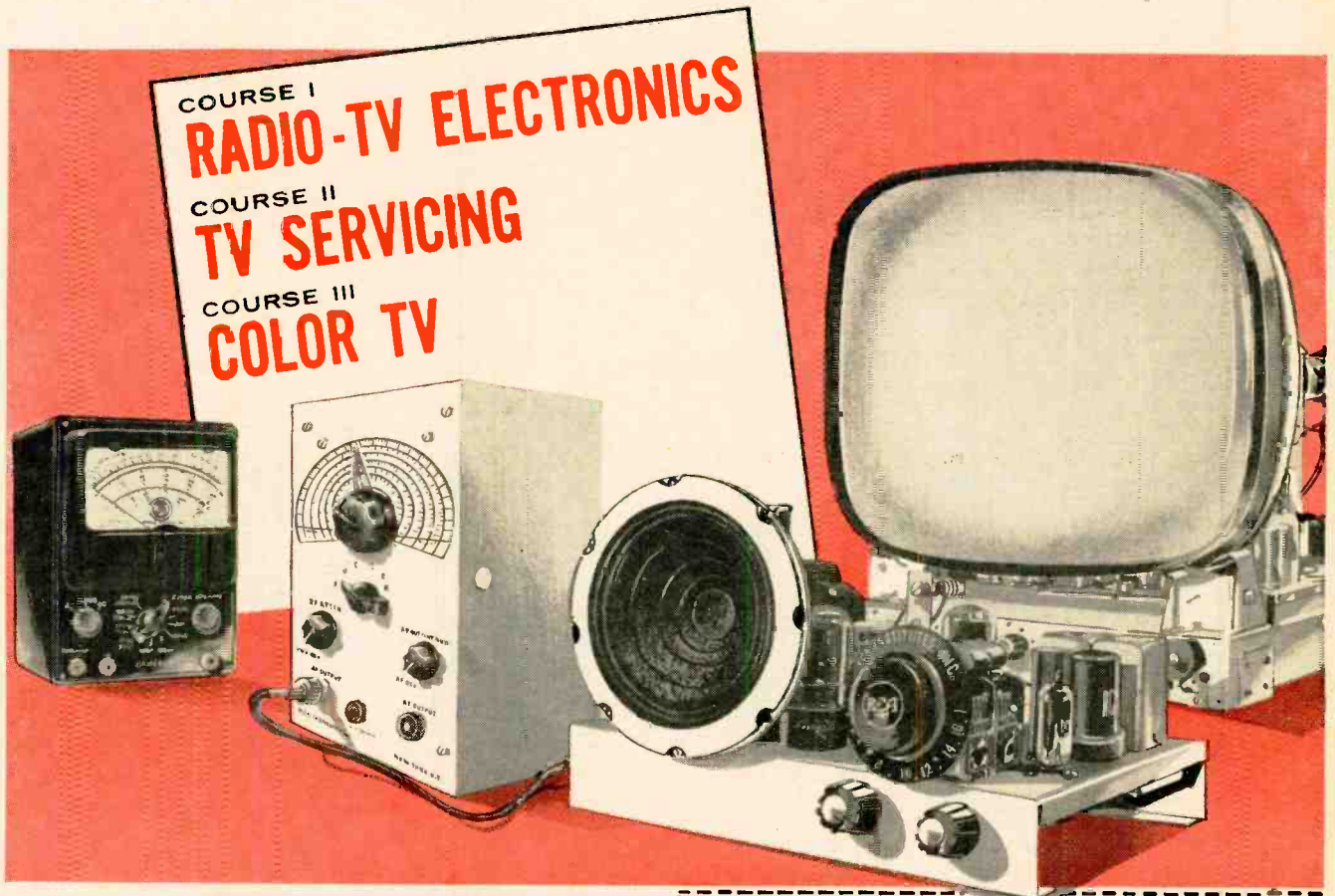

**COURSE I
RADIO-TV ELECTRONICS**
**COURSE II
TV SERVICING**
**COURSE III
COLOR TV**

The equipment illustrated and text material you get with each course is yours to keep. Practical work with very first lesson. Courses for the beginner and the advanced student. Pay-as-you-learn. You need pay for only one study group at a time.

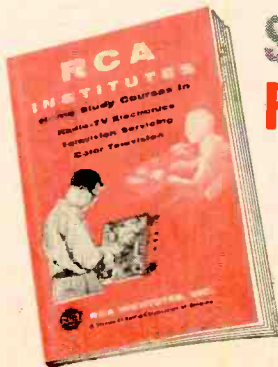

**SEND FOR THIS
FREE BOOK NOW**

Resident School courses in New York City offer comprehensive training in Television and Electronics. Day and evening classes start four times each year. Detailed information on request.

RCA Institutes, Inc. Home Study Dept. RE-98
 A Service of Radio Corporation of America
 350 West Fourth Street, New York 14, N. Y.

Without obligation, send me FREE 52 page CATALOG on Home Study Courses in Radio, Television and Color TV. No Salesman will call.

Name.....
 Please print

Address.....

City..... Zone.... State.....

Korean Vets! Enter discharge date.....

CANADIANS—Take advantage of these same RCA courses at no additional cost. No postage, no customs, no delay. Send coupon to:

RCA VICTOR COMPANY, LTD.
 5001 Cote de Liesse Rd., Montreal 9, Que.

To save time, paste coupon on postcard

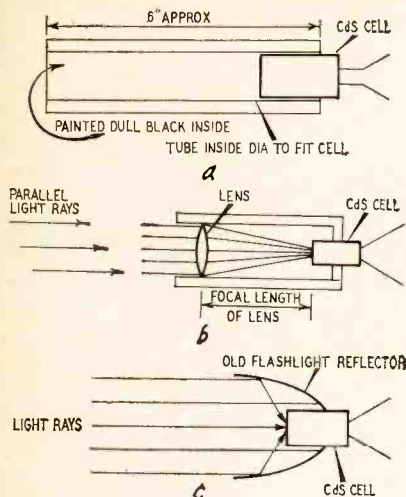

Fig. 4—Three ways of mounting the cell,

as headlight-operated outdoor advertising signs.

Photocell relay circuits operate on a change in light intensity. Therefore, if an alarm or signal circuit is to operate during both daylight and darkness, the photocell must be placed in a tube to eliminate stray side lighting, as shown in Fig. 4-a. A similar arrangement with a lens is shown in Fig. 4-b.

A parabolic reflector from an old flashlight can be used to concentrate light on the crystal (Fig. 4-c). Move the cell around until the reflector focus is found. Even for the best adjustment, some of the light from the reflector will hit the photocell case and not reach the CdS crystal. This limits the practical sensitivity increase to about four times for the flashlight reflector.

Because of the small crystal size, the cell makes an excellent detector of small movements. Suppose a light mask with a hole the size of the crystal is placed immediately in front of the cell. A 1-millimeter movement of the mask would then cut the light completely on or off. A radio dial light would be a satisfactory light source.

For any application the necessary light-source strength depends upon its distance from the cell. A little experimenting with lights will give the answer but the following examples should give an indication of the sensitivity that can be expected.

Properly adjusted, the circuit of Fig. 3 will operate at night from a two-cell flashlight at a distance of 75 to 100 feet. Fig. 1 opens and closes with the interruption of living-room illumination just sufficient to read by. It makes a good circuit for automatically operating outdoor or house lighting or radio tower lights at sundown.

The CdS cell has one disadvantage that has not been mentioned. It has a time constant—it does not respond instantly to an increase or decrease in light. This time constant is usually about 5 msec. For most applications this time lag is insignificant since the

The 2D21 relay circuit.

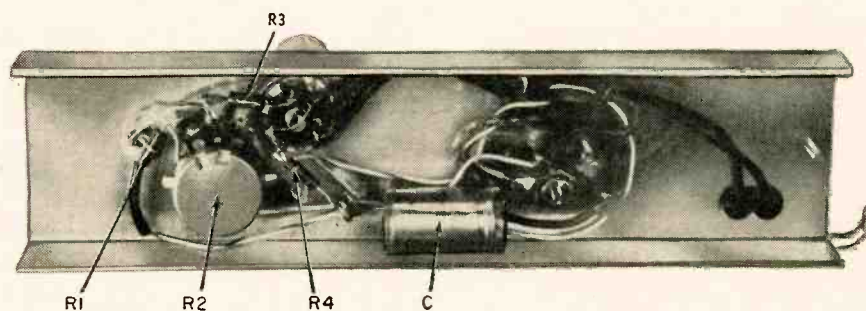
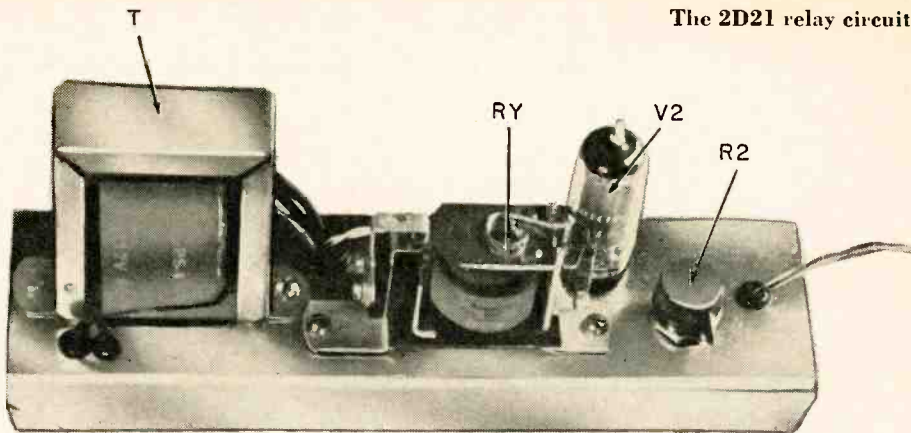

Plenty of room for all parts under the 2D21 chassis.



A cadmium sulfide (CdS) crystal photocell.



CLAIREX CL-2 CdS CELL

relays are even slower. It does, however, make the cell unsuitable for high-speed time-interval measurements. Also, the time constant results in a high-frequency rolloff in response to modulated light.

Circuit sensitivity can be further increased by using a Clairex CL-3. This is a cadmium selenide cell which is extremely sensitive in the red and near infra-red region of the visible spectrum.

END

DIODE CLIPPER-LIMITER

By RUFUS P. TURNER

Simple clipper-limiter circuits using diodes are now old hat. These devices have been widely used as amplitude limiters. They have also been used for forming quasi-square waves from a sine-wave input.

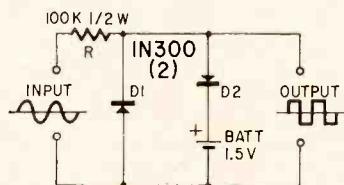

This circuit (see diagram) is somewhat simpler and considerably better than earlier ones. The superior front-to-back resistance ratio of the silicon-junction diodes used in this model improves

clipper performance at low signal levels. Furthermore, because of the very low reverse current of the silicon-junction diode (much less than 1/1,000 micro-ampere at 1.5 volts!), no on-off switch is needed.

Only one battery is required and this will give shelf life thanks to the infinitesimal amount of current used by the circuit. Because of this low current drain, the smallest-sized penlight cell can be used.

The circuit provides good limiting action on both positive and negative peaks up to 150 kc. Beyond this point, circuit stray capacitances and the significant internal capacitance of the silicon junction both act to lower performance.

It's packed with career facts!

SEND FOR THIS
FREE
BOOKLET TODAY

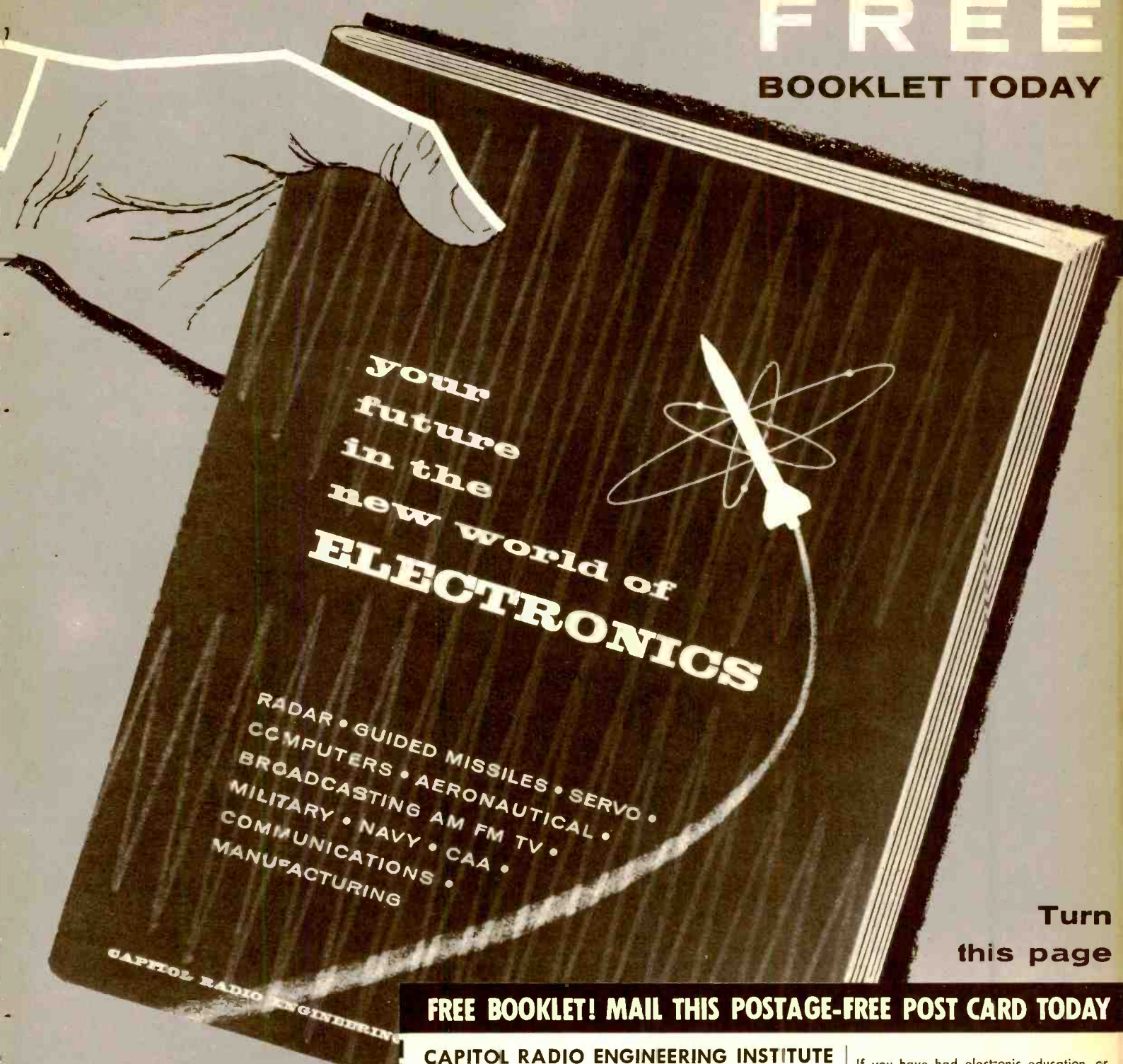

your
future
in the
new world of
ELECTRONICS

RADAR • GUIDED MISSILES • SERVO •
COMPUTERS • AERONAUTICAL •
BROADCASTING AM FM TV •
MILITARY • NAVY • CAA •
COMMUNICATIONS •
MANUFACTURING

CAPITOL RADIO ENGINEERING INSTITUTE

Turn
this page

FREE BOOKLET! MAIL THIS POSTAGE-FREE POST CARD TODAY

CAPITOL RADIO ENGINEERING INSTITUTE

ECPD Accredited Technical Institute Curricula • Founded 1927

Dept. 149-E

3224 16th St., N.W., Washington 10, D. C.

RA1

(R.N. Nov. 58)

Please send me your course outline and FREE illustrated Booklet "Your Future in the New World of Electronics" . . . describing opportunities and CREI home study courses in Practical Electronic Engineering Technology.

- | | | |
|---|---|---|
| CHECK
FIELD OF
GREATEST
INTEREST | } | <input type="checkbox"/> Radar, Servo and Computer Engineering Technology |
| | | <input type="checkbox"/> Electronic Engineering Technology |
| | | <input type="checkbox"/> Broadcast (AM, FM, TV) Engineering Technology |
| | | <input type="checkbox"/> Television Engineering Technology |
| | | <input type="checkbox"/> Aeronautical Electronic Engineering Technology |

Name..... Age.....

Street.....

City..... Zone..... State.....

Check: Home Study Residence School Korean Veteran

If you have had electronic education, or experience in electronics—and realize the need of a high-level technical knowledge to make good in the better electronic jobs—you can qualify for CREI home study training. (Electronics experience is not required for admission to CREI Residence School.) Please fill in the following information.

Employed By.....

Type of Present Work.....

Education:

Yrs. High School.....

Yrs. College.....

Electronics Experience.....

See what
the rapidly
expanding
field of
ELECTRONICS
offers you

CREI prepares you quickly for success in

The future is in your hands!

The signs are plain as to the future of the trained men in the electronics industry. It is a tremendous industry, but—when there's a choice between a trained and untrained applicant, the trained man will get the job. Your biggest problem is to decide on—and begin—the best possible training program.

**CREI Home Study . . .
The Quick Way to Get There.**



Since 1927, CREI has given thousands of ambitious young men the technical knowledge that leads to more money and security. The time-tested CREI procedure can help you, too—if you really want to be helped. CREI lessons are prepared by experts in easy-to-understand form. There is a course of instruction geared to the field in which you want to specialize. You study at your convenience, at your rate of speed. Your CREI instructors guide you carefully through the material, and grade your written work personally (not by machine).

Industry Recognizes CREI Training.

CREI courses are prepared, and taught with an eye to the needs and demands of industry, so your CREI diploma can open

many doors for you. Countless CREI graduates now enjoy important, good-paying positions with America's most important companies. Many famous organizations have arranged CREI group training for their radio-electronics-television personnel. To name a few: All-American Cables and Radio, Inc.; Canadian Broadcasting Corporation; Columbia Broadcasting System; Gates Radio Company; Federal Electric Corporation; The Martin Company; Douglas Aircraft Co.; U.S. Information Agency (Voice of America); Trans-Canada Air Lines; United Air Lines. Their choice for training of their own personnel is a good cue for your choice of a school.

Benefits Felt Right Away.

Almost immediately you feel the benefits of CREI training. Your employer, when informed of your step toward advancement (only at your request), is certain to take new interest in you and in your future. What you learn in CREI Home Study can start helping you do a better job immediately.

CREI also offers Residence Training in Washington, D. C.

at the same high technical level. Day and evening classes start at regular intervals. Qualified residence school graduates earn

- RADAR
- GUIDED MISSILES
- SERVO-MECHANISMS
- COMPUTERS
- AERONAUTICAL ELECTRONICS
- BROADCASTING, AM, FM, TV
- MILITARY, NAVY, CAA ELECTRONICS
- COMMUNICATIONS
- ELECTRONICS MANUFACTURING

degree as "Associate in Applied Science." Check coupon if you prefer residence or home study information . . . or write, Capitol Radio Engineering Institute, 3224 16th St. N.W., Washington 10, D.C.

PAYS FOR ITSELF QUICKLY. Your very first raise could repay your investment in CREI training, and leave you a profit the very first year. Your increases in pay thereafter are all pure profit, and you'll be prepared for many more promotions and pay raises in the future years of your life.

ELECTRONIC TECHNICIANS

Growing Peninsula Co. has openings for 1st class electronic technicians to work directly with engineering in development of new products. Only those with CREI or equal training and 3 years minimum commercial experience will be considered. Top salaries to qualified applicants. Call Mr. McQueeney, DA. 4-4733 for appointment. ALTO SCIENTIFIC Co., Inc. 855 COMMERCIAL ST. PALO ALTO

ENGINEERING AIDES AND TECHNICIANS

Immediate Positions Available

CREI or other formal electronic training desirable.

Experienced in reading schematics, bread board construction of electronic circuits and chassis preparation.

EMERSON RESEARCH LABORATORY

Industry Calls for CREI Training by Name So Should You!

Here you see actual help wanted ads—one from a San Francisco newspaper, another seen in Washington. They are just two of many which specify "CREI or equal" education. This shows that industry approves CREI training, even insists on it. Experience has taught many, many companies that CREI students are taught what industry needs and wants them to know. Let this be your cue when you choose your educational program.

Send card today for this fact-packed booklet. It's free.



Take 2 minutes to send for this booklet right now. We'll promptly send your copy. The rest—your future—is up to you.

1st Class

Permit No. 288-R

Washington, D. C.

BUSINESS REPLY CARD

No Postage Stamp Necessary If Mailed in United States

Postage Will Be Paid By

CAPITOL RADIO ENGINEERING INSTITUTE

3224 16th Street, N.W.

Washington 10, D. C.

ELECTRONICS

How's Your Scientific Knowledge?

By **RUDOLF F. GRAF**

MANY scientists have made invaluable contributions in the audio and electronic field. Some of their names have been perpetuated by physical phenomena or quantities named after them, while others have made their contribution and their names have gone into obscurity.

Test your knowledge of these 20 men, without whom radio, radar, television, hi fi and many other present-day miracles would not be possible. Match their names with one of their better known scientific discoveries or quantities or phenomena to which their names have been linked.

If you know them all, our hat's off to you. A score of 17 to 19 correct is very good indeed and 14 to 16 is about average. Simply write the letter found in the lower part of column after the numeral preceding the name of the man who made that particular discovery.

Answers are on page 135.

The men

- 1 André M. Ampère
- 2 Anders J. Angstrom
- 3 Alexander G. Bell
- 4 Lee de Forest
- 5 Christian Doppler
- 6 Thomas A. Edison
- 7 Michael Faraday
- 8 Harvey Fletcher
- 9 Jean B. J. Fourier
- 10 Karl F. Gauss
- 11 William Gilbert
- 12 Joseph Henry
- 13 Gustav R. Kirchhoff
- 14 Joseph J. Thomson
- 15 H. F. Emil Lenz
- 16 Guglielmo Marconi
- 17 Wilhelm K. Roentgen
- 18 Wallace C. Sabine
- 19 Alessandro Volta
- 20 Vladimir K. Zworykin

Their accomplishments

- A Wave analysis
- B Network theories
- C Capacitance
- D First practical wireless
- E Magnetomotive force
- F Potential difference
- G Light wavelength
- H Flux density
- I Frequency change
- J Electron
- K Current
- L Iconoscope
- M Inductance
- N Triode
- O Sound measurement
- P Sound recording
- Q Current-flux relationship
- R Telephone
- S X-ray
- T Sound range

END

NO OTHER TUBE TESTER MADE - AT ANY PRICE - can MATCH the VALUE of the CENTURY FAST-CHECK



SIZE:
H: 11 1/4"
W: 14 5/8"
D: 4 3/8"

Model FC-2—housed in rugged oak carrying case complete with CRT adapter . . . only

Guaranteed for
One Full Year
\$69.50
Net

20,000 SERVICEMEN CAN'T BE WRONG!

See for yourself—AT NO RISK—why over 20,000 servicemen selected the FAST-CHECK above all other tube testers—regardless of price. With the FAST-CHECK you will make every call pay extra dividends by merely showing your customer the actual condition and life expectancy of the tube. The extra tubes you will sell each day will pay for the FAST-CHECK in a very short time.

Special compartment accommodates line cord and Picture Tube Test Adapter

PICTURE TUBE TEST ADAPTER INCLUDED WITH FAST-CHECK

Enables you to check all picture tubes (including the new short-neck 110 degree type) for cathode emission, shorts and life expectancy . . . also to rejuvenate weak picture tubes. This feature eliminates the need of carrying extra instruments and makes the FC-2 truly an all-around tube tester.

FAST-CHECK'S low price is made possible because you are buying direct from the manufacturer.

Just 2 settings on the FAST-CHECK TUBE TESTER tests over 650 tube types completely, accurately — AND IN SECONDS!

- **POSITIVELY CANNOT BECOME OBSOLETE**
Circuitry is engineered to accommodate all future tube types as they come out. New tube listings are furnished periodically at no cost.
- **NO TIME CONSUMING MULTIPLE SWITCHING**
Only two settings are required instead of banks of switches on conventional testers.
- **NO ANNOYING ROLL CHART CHECKING**
Tube chart listing over 650 tube types is conveniently located inside FAST-CHECK cover. New tube listings are easily added without costly roll chart replacement.

COMPARE FAST-CHECK WITH OTHER TESTERS RANGING FROM \$40 TO \$200

RANGE OF OPERATION

- ✓ Checks quality of over 650 tube types, which cover more than 99% of all tubes in use today, including the newest series-string TV tubes, auto 12 plate-volt tubes, OZ4s, magic eye tubes, gas regulators, special purpose hi-fi tubes and even foreign tubes.
- ✓ Checks for inter-element shorts and leakage.
- ✓ Checks for gas content.
- ✓ Checks for life-expectancy.

IMPORTANT FEATURES

- Checks each section of multi-section tubes and if only one section is defective the tube will read "Bad" on the meter scale
- Less than 10 seconds required to test any tube
- 41 long lasting phosphor-bronze tube sockets accommodate all present and future tube types . . . cannot become obsolete
- 7-pin and 9-pin straighteners mounted on panel
- Large D'Arsonval type meter is extremely sensitive yet rugged—fully protected against accidental burn-out
- Special scale on meter for low current tubes
- New tube listings furnished periodically at no cost
- Compensation for line voltage variation.

Other testers may have some of the above features . . . but only the **FAST-CHECK has them all!**

SHIPPED ON APPROVAL FOR 10 DAY FREE TRIAL

Try the FC-2 before you buy it! No obligation to buy.

PAY IN SMALL MONTHLY PAYMENTS

Easy to buy if you're satisfied. Pay at net cash price . . . no financing charges.

**NO MONEY REQUIRED
WITH ORDER . . .**

CENTURY ELECTRONICS CO., INC.

Dept. 109, 111 Roosevelt Ave., Mineola, N. Y.

Rush the FAST-CHECK for a 10 day trial period. If not completely satisfied I will return the instrument within 10 days without further obligation. If fully satisfied I agree to pay the down payment within 10 days and the monthly installments as shown. No financing charges are to be added.

Model FC-2 . . . \$69.50 — Pay \$14.50 within 10 days. Balance \$11.00 monthly for 5 months.

Name

Address

City State

F.O.B., Mineola, N. Y.

Sync-circuit Subber

Speed servicing of those tricky sync circuits. Substitute known good circuits to find the bad one in the receiver

By W. G. ESLICK

REPAIRING TV receiver sync circuits is easier said than done. To find out what section of the set is causing horizontal pulling, tearing or jitter—sync clipper, phase detector, or horizontal oscillator—takes a lot of painstaking circuit checking. Vertical roll or unstable vertical oscillators present the same problem—is it the oscillator or the output stage?

To make the job easier, I designed the sync-circuit subber described in this article. Built almost completely from junkbox parts, this unit has provisions for substituting for each of the mentioned circuits and thus determining whether it is or isn't the faulty one. As the unit delivers only about 30 volts peak to peak at the VERT OUT jack, it will not fill the screen on most sets. But this doesn't matter, all we really want to know is if the vertical is clean on the TV set—no roll or distortion. The HORIZ OUT jack delivers 200 volts, husky enough for all purposes.

No special layout was followed, but keep the vertical and horizontal outputs away from the sync circuits—you don't want any heavy pulses in the inputs.

With switches S1, S2 and S3 down, the circuits they control—phase detector, horizontal oscillator, and vertical oscillator—are connected to the appropriate input jacks and are independent of each other. Throwing these switches up interconnects various sections of the subber, thus making it possible to substitute for either one section or a major part of a TV receiver's sweep circuits.

Half of V1 is a sync clipper using positive-going sync pulses in the input. The other half of this tube is a phase detector which corrects the horizontal frequency. A pulse can be fed to the phase detector's cathode from the sync clipper and a sample oscillator voltage pulse to its plate. This plate can be coupled to the horizontal oscillator grid through R6 and S2. When the oscillator is in step, the phase-detector output is zero. This output becomes a negative, or positive voltage, depending on whether the oscillator is running

slow or fast, and it corrects the horizontal oscillator frequency.

The horizontal oscillator is a multivibrator without any frills other than the feedback circuit to the phase detector. The multivibrator includes a ringing coil and hold control. The vertical oscillator is a blocking oscillator with a hold control and height adjustment. The rectifier is a 6X5-GT. I could

have used a 6X4, but the chassis had already been punched for larger sockets.

All front-panel jacks are banana types and the cables have banana plugs on one end and alligator clips on the other. The ground lead is connected directly to the subber's ground and an alligator clip is attached to its loose end.

A 12AU7 can be used instead of the

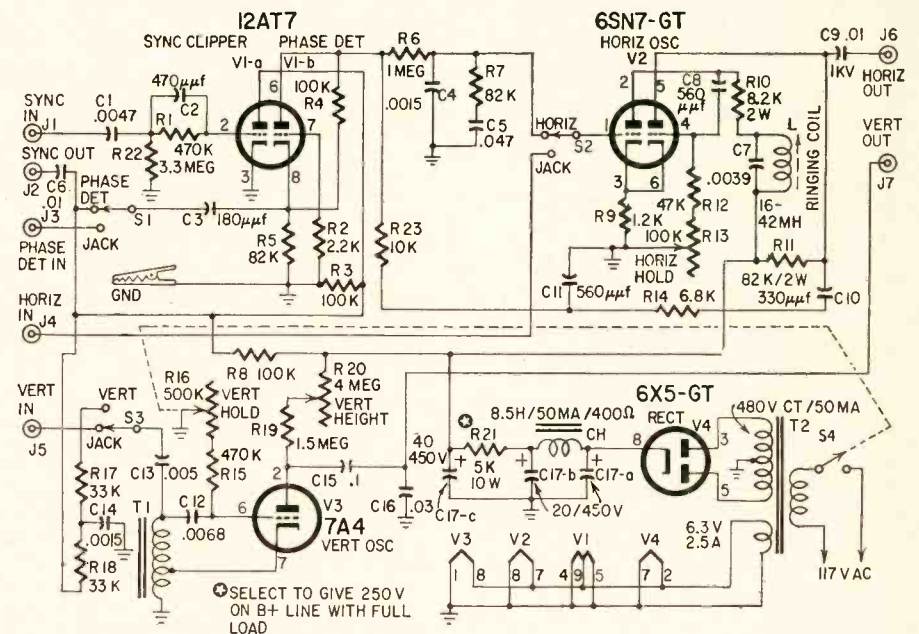

- R1—15—470,000 ohms
- R2—2,200 ohms
- R3, 4, 8—100,000 ohms
- R5, 7—82,000 ohms
- R6—1 megohms
- R9—1,200 ohms
- R10—8,200 ohms, 2 watts
- R11—82,000 ohms, 2 watts
- R12—47,000 ohms
- R13—pot, 100,000 ohms, linear taper
- R14—6,800 ohms
- R16—pot, 500,000 ohms, linear taper, with spst switch S4
- R17, 18—33,000 ohms
- R19—1.5 megohms
- R20—pot, 4 megohms, linear taper
- R21—5,000 ohms, 10 watts, select to give 250 volts on B+ line with full load
- R22—3.3 megohms
- R23—10,000 ohms
- All resistors 1/2-watt 10% unless noted
- C1—.0047 μ f
- C2—470 μ f
- C3—180 μ f
- C4, 14—.0015 μ f
- C5—.047 μ f
- C6—.01 μ f

- C7—.0039 μ f
- C8, 11—560 μ f
- C9—.01 μ f, 1,000 volts
- C10—330 μ f
- C12—.0068 μ f
- C13—.005 μ f
- C15—.01 μ f
- C16—.03 μ f
- C17—20—20—40 μ f, 450 volts, electrolytic
- CH—8.5 henries, 50 ma, 400 ohms
- J1, 2, 3, 4, 5, 6, 7—banana jacks
- L—ringing coil, 16-42 mh, (G-E RLI-210, Miller 6210 or equivalent)
- S1, 2, 3—spdt toggle
- S4—spst on R16
- T1—vertical blocking oscillator transformer (G-E RTO-192, Triad A-120Z, Stancor A-8126 or equivalent)
- T2—power transformer: primary, 117 volts; secondary, 480 volts ct, 50 ma; 6.3 volts, 2.5 amps (Merit P-3147 or equivalent)
- V1—12AT7
- V2—6SN7-GT
- V3—7A4
- V4—6X5-GT
- Chassis to suit
- Miscellaneous hardware

Sync-circuit subber is built from junkbox parts.

NOW READY! McGraw-Hill's New Train-Yourself Course



FIX TV RADIO and RECORD CHANGERS RIGHT AWAY

—even if you've never looked inside a set before!

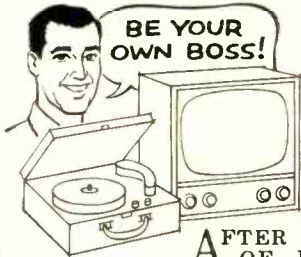

AT LAST — at Amazing LOW COST — The Most Complete TV-Radio Repair Course Ever Published. TELLS and SHOWS How to Do Every Job Quickly and Easily — Make GOOD MONEY, Full or Spare Time in the BOOMING Repair Business

AFTER 10 YEARS OF PREPARATION — McGraw-Hill's new 6-Volume Course brings you everything you need to know to "cash in" on the TV-RADIO boom. Over 2,350 pages of money-making "know-how" by top factory engineers and electronic experts. **THREE** giant REPAIR MANUALS tell and show how to FIX every trouble the *easy way*. **TWO** huge TROUBLESHOOTERS tell exactly WHERE to begin, WHAT tools to use, HOW to "polish off" every job. Complete Home Study Volume guides you every step of the way, tells how to get ahead fast as a repairman — build up your own business, full or spare time, for **BIG PROFITS!**

EARN While You Learn

Tested — and now used in top schools, and repair shops — Course volumes are simple enough for green beginners, amazed "pros" with new easy methods. Starts you doing simple repairs — and earning money — from very first chapter. ABC pictures and directions make tougher jobs a "snap." Before you finish you can earn many times its cost.

NO previous training needed. NO complicated formulas. PLAIN ENGLISH

pictures and directions cover ANY job on EVERY set — tubes, circuits, speakers, new a-c/d-c portables, Color TV, even what to charge for every job!

BIG MONEY — Spare or Full Time

Forget lack of experience. Forget your age. Over 40 MILLION TV sets, 130 MILLION radios — and the *shortage* of repairmen — mean big money for you. Course makes it easy to "cash in," spare time or full, start your own business, enjoy your work and a big bank account!

SEND NO MONEY

Try Course 10 days FREE. (We pay shipping!) If you don't agree it can get you started in a money-making repair business — return it, pay nothing. Otherwise keep it. Earn while you learn; and pay the low cost on easy terms. Mail coupon NOW. McGraw-Hill Book Co., Dept. RE-9, 327 West 41st St., New York 36, N. Y.

Examine Entire Course **FREE** for 10 Days!

THIS AMAZING OFFER SAVES YOU \$11.85!

PARTIAL CONTENTS

- 1 **Television and Radio Repairing** — Testing, repairing, replacing parts, 566 pages. 700 "This-Is-How" pictures, diagrams. By John Markus, Feature Ed., Electronics Magazine.
- 2 **Practical Radio Servicing** — Easy-to-follow directions, diagrams, drawings — with job sheet for every repair job. 599 pages. 473 illus. By William Marcus, Alex Levy, Electronic Training Experts.
- 3 **Profitable Radio Troubleshooting** — WHERE to look and WHAT to do for every trouble. How to avoid costly mistakes, handle customers profitably. 330 pages. 153 "how-to" illus. By William Marcus, Alex Levy.
- 4 **Profitable TV Troubleshooting** — Short-cuts to SPOT and FIX every trouble — fast, for big profits. By Eugene A. Anthony, Service Consultant, General Elec. Co.
- 5 **Repairing Record Changers** — Step-by-step pictures and directions — how to set up service bench, etc. 278 pages. 202 A-B-C pictures. By Eugene Ecklund, Eng. DuMont Lab., Inc.
- 6 **Complete Home Course Outline** — Getting started in television and radio servicing. How to get the most out of your Course. How to get ahead FAST. By John Markus.

Free ALL THREE Valuable Repair Aids: TV, RADIO, and CIRCUIT Detect-O-Scopes (Total Retail Value \$3.00)



FREE — whether you keep the Course or not — THREE amazing DETECT-O-SCOPE Charts. TV and RADIO Scopes enable you to spot all tube troubles in a jiffy. CIRCUIT Scope spots all circuit troubles. Make fix-it jobs easier, faster. 16 x 21 inches. ALL THREE (worth \$3.00) yours FREE while they last on this introductory offer.

THIS COUPON SAVES YOU \$11.85

McGraw-Hill Book Co., Dept. RE-9, 327 West 41st St., New York 36, N. Y.

Send me — postpaid — for 10 DAYS' FREE TRIAL the 6-Vol. McGraw-Hill TV, Radio and Changer Servicing Course. If okay, I'll remit only \$4.95 in 10 days; then \$5.00 monthly for 5 months. (A total savings of \$11.85 on the regular price of the Course and Detect-O-Scopes.) Otherwise, I'll return Course in 10 days; pay nothing.

ALSO send FREE (to keep whether or not I keep the Course) the 3 TV, RADIO, and CIRCUIT DETECT-O-SCOPE CHARTS, — total value \$3.00

Name (Please Print Clearly)

Address

City Zone No. (if any) State.....

CHECK HERE if you prefer to enclose first payment of \$4.95 with coupon. Same easy pay plan; same 10-day return privilege for full refund. RE-9

TEST INSTRUMENTS

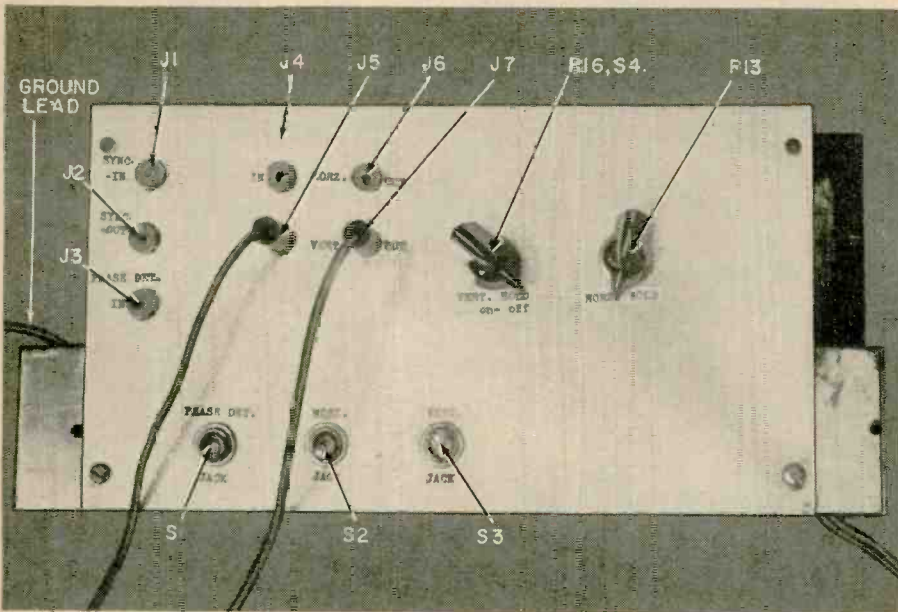

The front panel layout.

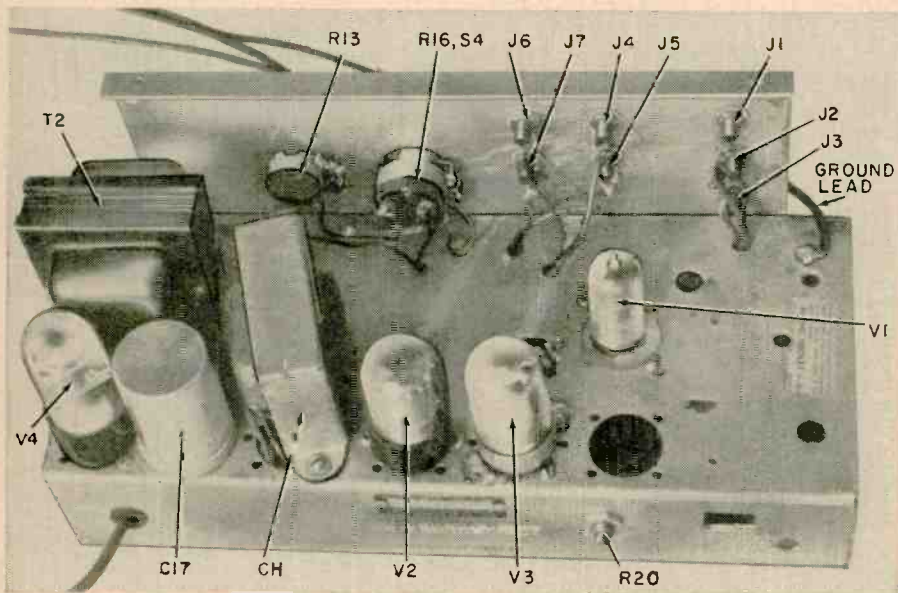

An old radio chassis was used for the subber. As you can see (below), the instrument could be made much smaller.

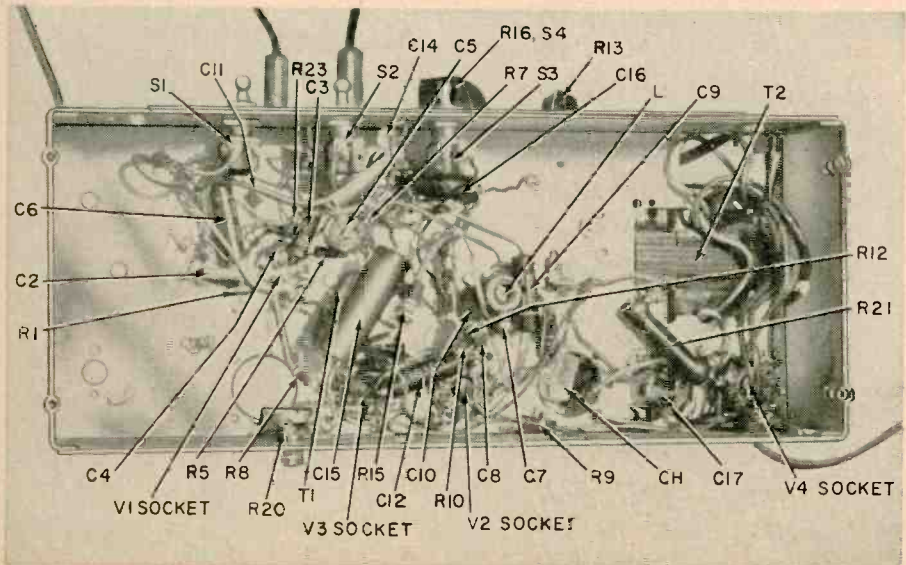

6SN7 if desired and a 6C4, 6J5 or 6C5 for the 7A4, but the values of C12, R19 and R15 may have to be juggled.

Subbing vertical circuits

When puzzled by short or stretched pictures due to some fault in the vertical deflection circuits, disconnect the receiver's vertical output section, leaving only the grid-load resistor to provide a complete grid circuit. Now, connect the subber's VERT OUT to this grid and the subber's ground lead to the TV chassis or common ground circuit.

With the receiver and subber on, adjust the subber's VERT HOLD control until the picture is nearly still. Adjust height as well as possible. There isn't any sync, so the picture will roll slowly, but you can tell if the picture is still short or stretched. If the trouble is still there, you know the output stage is faulty. If the picture returns to normal, look to the vertical oscillator for trouble.

To lock the vertical sync (if deemed necessary) flip switch S3 up to the VERT position. With this switch up, the subber's sync circuit is switched in. Now connect a cable to the SYNC IN jack and touch the other end (with the alligator clip) to the set's video detector. If vertical sync won't lock here, go to the plate of the set's sync amplifier and then try the grid and plate of the phase splitter, if the set has one.

With the SYNC IN cable connected to one of these points, the vertical sync will lock (where we can get a positive-going sync signal). In some sets, the video detector has a negative sync output while others have a positive output. A look at the set's schematic will tell, as most show video and pulse data on the diagram. This also holds true when looking for a spot to use to lock the horizontal sync.

For no vertical deflection (a straight horizontal line across the screen) when your scope shows no drive at the vertical output tube's grid and voltages seem OK, a quick check can be made without unsoldering or cutting any leads. Flip all subber switches down. Using the VERT OUT lead (subber ground connected to the TV set), touch the grid of the receiver's vertical output tube. If this gives you vertical deflection, back up to the vertical oscillator's plate.

If the sweep disappears, look for an open coupling capacitor or a shorted wave-shaping network. If the plate point gives vertical deflection, go to the oscillator's grid. You are interested only in vertical scan on the TV screen, not in how good or bad it is. If you have vertical sweep, you are using both the vertical oscillator and vertical output tubes in the TV set as amplifiers for the subber's oscillator and everything will be out of proportion. But now you know that the trouble is in the transformer or associated components if a blocking oscillator is used, or a

TEST INSTRUMENTS

faulty feedback network if the output stage feeds back a small voltage to the input of the first tube.

Now the horizontal circuits

For no horizontal sweep or high voltage, touch the HORIZ OUT lead to the grid of the receiver's horizontal output tube. If sweep and high voltage reappear, we have eliminated the output stage as the trouble spot.

If you have horizontal sweep, but some kind of horizontal trouble exists, disconnect everything but the grid-load resistor on the TV's horizontal output stage and connect the subber's HORIZ OUT to this grid. With switch S2 down (freeing the subber's horizontal oscillator from all other subber circuits), either pull the horizontal oscillator tube from the set or clip all connections from the input side of the first section (usually the grid that goes to some sort of an afc circuit) and connect these leads to the subber's HORIZ IN jack.

Here, you are substituting only for the set's horizontal oscillator and are using the receiver's afc and sync circuits. If the set works properly, the trouble is in the circuit being replaced by the subber—the horizontal oscillator circuit. If you still have trouble, disconnect the subber's HORIZ IN from the TV set, flip switch S2 up to HORIZ and switch S1 down. Now the subber's phase detector is connected to the subber's horizontal oscillator and the phase detector is connected only to the PHASE DET IN jack.

Connect a cable from this jack to the set's sync amplifier plate or grid, or to the sync clipper's grid or plate (or phase splitter grid or plate) till horizontal sync locks (adjusting the subber's HORIZ HOLD control, of course).

One thing to remember: If you go back beyond the clipper to the sync amplifier, there may be enough video present to make the circuit unstable. If you still have trouble or are in doubt, throw switch S1 up and connect the cable to the SYNC IN jack and go from the video detector to the sync amplifier grid or plate till proper polarity pulses are found. Now you have subbed the clipper, phase detector and horizontal oscillator.

A word to the wise: On the TV set's horizontal oscillator grid from afc, there is usually an R-C network called an anti-hunt circuit. Be sure these components are good and have proper grounds.

The sync clipper in the subber can be used by itself. When doing so, disconnect grid and plate leads to this tube in the receiver or pull the tube.

This unit is simply a tester to help speed servicing. It is not 100% perfect, but it has performed well wherever it has been used. It tells you if you do or don't have trouble in a particular stage. Once the trouble is pinned down to a single stage, the repair job is comparatively easy. END

ANOTHER ADVANCE FROM SONOTONE

—world leader in ceramic cartridges:

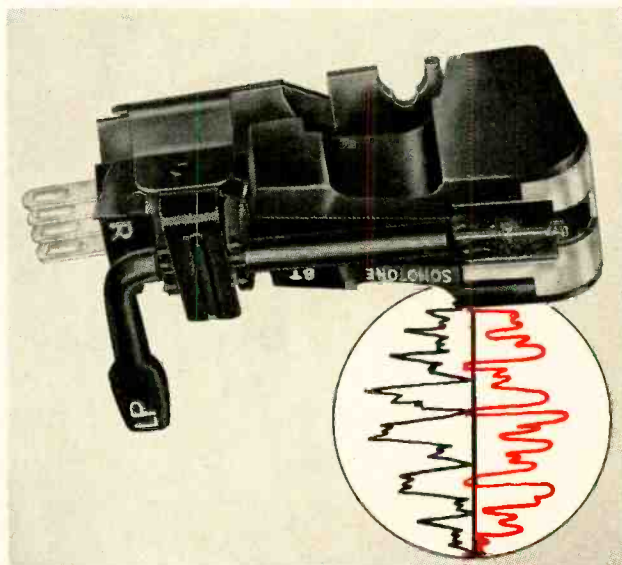

STEREO MODEL 8T COMPATIBLE CERAMIC CARTRIDGE

Plays both stereo and regular discs!

- Opens the door now to the biggest equipment boom since LP!
- Plays all 4 speeds—does *not* obsolete present equipment!
- Has Sonotone's unique, built-in vertical rumble suppressor so vital to stereo use! Doesn't need pre-amp!
- Famous Sonotone quality with top specifications!

The best thing that's happened to stereo discs!

Response Smooth from 20 to 12,000 cycles, gradual rolloff beyond.
 Output Voltage 0.3 volt.
 Compliance 2.0×10^6 cm/dyne.
 Recommended Load 1-5 megohms.
 Tracking Pressure 5-7 grams.
 Cartridge Weight 7.5 grams.
 Channel Isolation 20 decibels.
 Stylus Dual jewel tips, 0.7-mil microgroove and 3-mil 78 rpm.
 Mounting Dimensions... Standard 7/16 to 1/2 inch centers.

Priced at only

\$14⁵⁰
LIST
sapphire

\$24⁵⁰
LIST
diamond sapphire

Sonotone

Electronic Applications Division, Dept. CE-98

ELMSFORD, NEW YORK

you
can
measure

PHASE SHIFT

When used in combination with an oscilloscope, a differentiating amplifier makes accurate phase measurements possible

By TOM JASKI

PHASE meters are expensive instruments, and most experimenters cannot afford to invest in one for the infrequent phase measurements they make. So most of us measure phase with an oscilloscope and other available equipment.

However, measuring phase by comparing traces on a scope face is not an easy task, particularly if accuracy is required. We can use an electronic switch, overlap the traces and somehow measure the distance between zero points, using bezel marks as a reference. Or we can show an ellipse on the scope by feeding the original and phase-shifted voltages to the vertical and horizontal amplifiers, and measure phase by scaling the axes of the ellipse. These are familiar methods, which unfortunately are not particularly accurate.

The amplifier described in this article helps make the phase-measuring job easier and more accurate. It takes the original waves, makes sharp spikes out of them and mixes the spikes with the original voltage. This definitely and precisely marks the voltage in time. Thus the task of phase measurement is reduced to measuring the distance between sharply defined spikes and dividing the results. This is shown in Fig. 1. The distance between spikes of adjacent waves of the same phase is a full cycle, or 360°. The distance between spikes on both waves, divided by the distance of spikes on the same wave, is the phase-angle proportion of 360°. Thus, if the first measurement is one-fourth of the second, we have a 90° phase shift. Measuring the spike distances in Fig. 1-a, we find a 103° phase shift. The spikes in Fig. 1-b show an exact 108° shift. This method of using only the spikes has a disadvantage—if the phase shift approaches

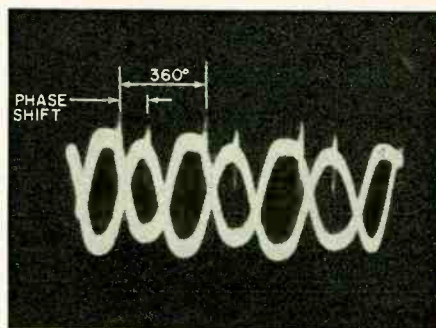

a

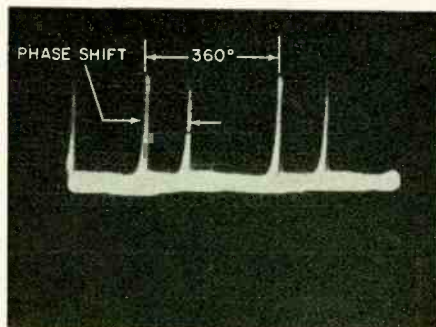

b

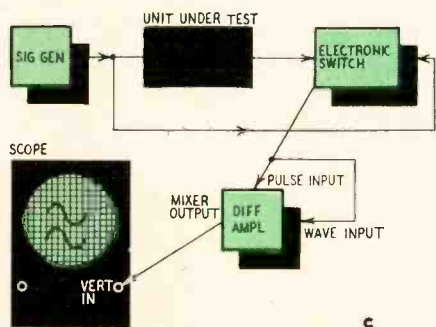

c

Fig. 1-a—Scope pattern shows a phase shift of 103°; b—phase shift of 108°; c—block diagram of setup for this test.

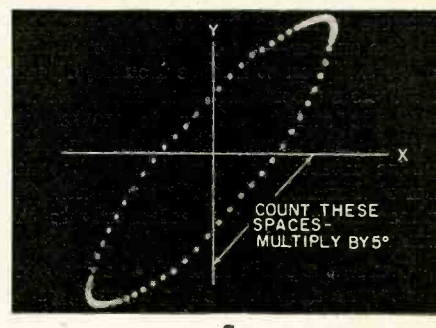

a

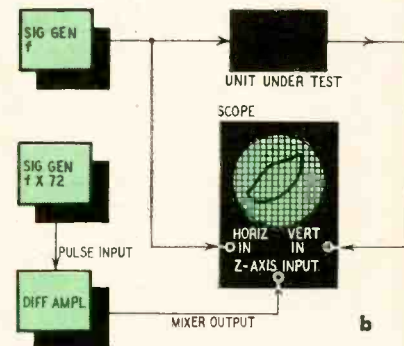

b

Fig. 2-a — Another pattern used to measure phase shift. Each dot represents a 5° phase shift; b—block diagram to obtain this pattern.

180° the pips may be difficult to distinguish as belonging to one voltage or the other.

If we make spikes at exactly 72 times the frequency at which we wish to measure phase shift, and feed these spikes to the grid of our scope cathode-ray tube, we see the pattern of Fig. 2. Here we use the vertical and horizontal amplifiers for the original and shifted voltages, respectively, to display an ellipse, which we then chop into 72

Cut testing time in half— DOUBLE TUBE SALES

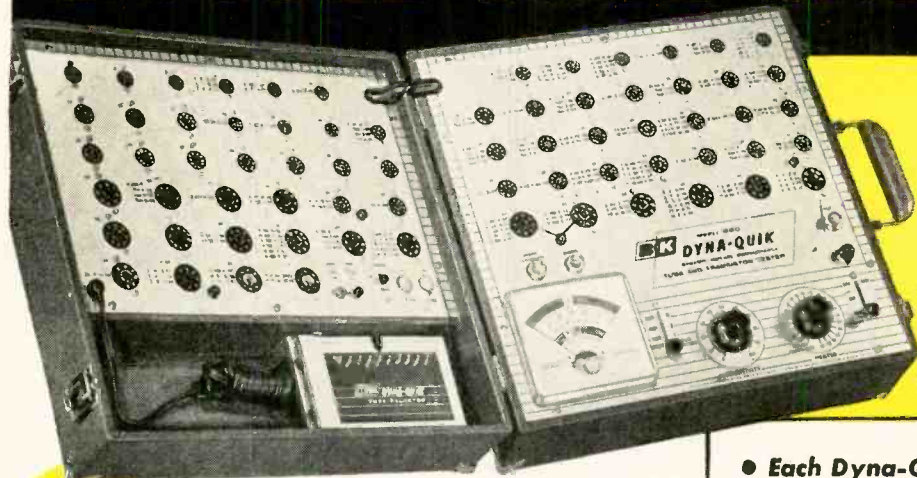

B&K **DYNA-QUIK**

*Makes Money for
Servicemen Everywhere*

**NEW
MODEL
650**

Fastest, Most Complete, Portable **DYNAMIC MUTUAL CONDUCTANCE TUBE & TRANSISTOR TESTER**

Checks over 99% of the tubes most widely used in television receivers, plus popular home and portable radio tubes. Tests over 500 tube types. Lists over 125 tube types, with settings, on socket panels for maximum operating speed. Complete listing in fast telephone-index type selector. Includes 16 spare sockets and sufficient filament voltages for future new tube types. Tests each section of multiple tubes separately for Gm—Shorts—Grid Emission—Gas Content—and Life. Provides instantaneous Heater Continuity check. Shows tube condition on "Good-Bad" scale and in micromhos. Special bridge assures automatic line compensation. No multiple switching—No roll chart. Includes pin straighteners. Transistor Tester checks junction, point contact and barrier transistors, germanium and silicon diodes, selenium and silicon rectifiers.

Net, **\$169⁹⁵**

- Each Dyna-Quik Tube Tester completely tests each tube in seconds
- Eliminates substitution testing
- Shows customer true condition and life expectancy of tubes
- Sells more tubes right on-the-spot
- Cuts servicing time, wins customer confidence
- Saves costly call-backs, brings more profit

One extra tube sale on each of 5 calls a day pays for the Dyna-Quik in a few weeks.

NEW MODEL 500B *Money-Making Portable* **DYNAMIC MUTUAL CONDUCTANCE TUBE TESTER**

Thousands of the famous B&K Dyna-Quik are in profitable use today by service technicians everywhere. Servicemen say: "Best tube tester I've ever owned for speed and dependability." "Makes money. Really indispensable!" "Have two...one for the shop and one for house calls!"

Now, with more tube sockets, the new Model 500B makes it easy to test more tubes faster and make more money. Accurately quick-checks most of the TV and radio tubes usually encountered in everyday service work. Tests tubes for shorts, grid emission, gas content, and leakage. Measures true dynamic mutual conductance with laboratory accuracy in the home or shop. Makes complete tube test in seconds, tests average TV set in a few minutes. Quickly detects weak or inoperative tubes. Shows tube condition on "Good-Bad" scale and in micromhos. Life Test shows customer the tube life expectancy. Makes it easy to sell more tubes right-on-the-spot.

One switch tests everything. No multiple switching. No roll chart. Automatic line voltage compensation. 7-pin and 9-pin straighteners. New tube reference charts are made available by the factory at regular intervals.

Net, **\$129⁹⁵**



2 additional tube sales per call on an average of 5 calls a day can increase your income as much as \$50.00 per week

See your B & K Distributor,
or write for Bulletin AP12-E

B&K

B&K MANUFACTURING CO.

3726 N. Southport Ave., Chicago 13, Illinois

Canada: Atlas Radio Corp., 50 Wingold, Toronto 10, Ont.

Export: Empire Exporters, 458 Broadway, New York 13, U.S.A.

TEST INSTRUMENTS

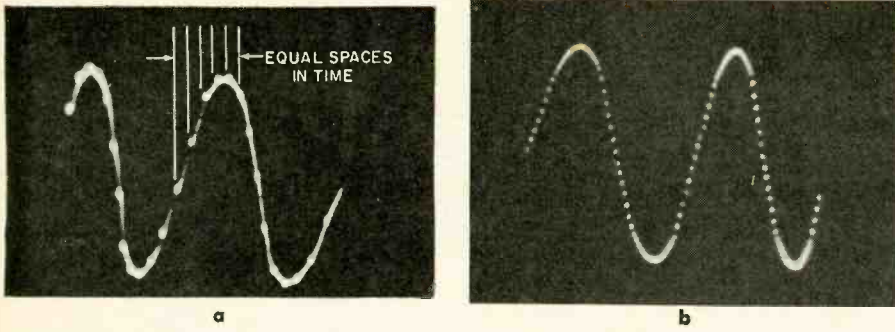

Fig. 3—Marking waveform with dots for frequency measurement, using: a—positive pulses; b—negative pulses; c—test setup.

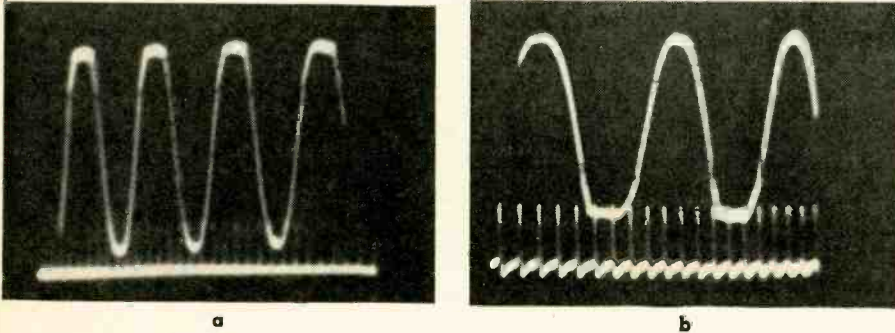

Fig. 4—Timing scales on scope screen for frequency calculations: a—10-ke; b—100-ke; c—block diagram of test setup.

pieces with the amplifier. Using the markings on our bezel to line the ellipse up in the exact center of X and Y axes, we need only count the spaces between dots in one quadrant to find the phase angle in steps of 5°. In Fig. 2 there are 5.8 spaces (the last digit is estimated) between the axes in the fourth quadrant, thus we have $5.8 \times 5 = 29^\circ$ of phase shift. To those familiar with ellipse shapes at various phase angles, it will be obvious that this is an accurate figure.

Besides the phase-measuring aids this little tool can provide, here are some other uses for it:

1. Forming trigger pulses for scope sweep or gating.

2. Marking ellipses for frequency measurement.

3. Marking waveforms with dots or holes, as shown in Fig. 3, for frequency measurement or waveform analysis. The pips being exactly spaced in time will divide the wave picture for graphical analysis.

4. Providing timing scales on the oscilloscope face with the use of a frequency standard, as shown in Fig. 4.

5. A general-purpose pulse type amplifier for scope Z-axis modulation.

6. Making fast single-sweep traces on the scope.

7. A simple but, for some purposes, adequate pulse modulator.

The experimenter will be able to

think of many other uses for this versatile instrument.

The circuit

Now let's examine the circuit that performs all these tricks. Fig. 5 is the complete diagram. The first three stages are conventional overdriven amplifiers using 6AK5 pentodes, which square almost anything presented at the input. (Note that the time constants of the circuit are gradually diminished as we progress through the stages.)

The squared voltage at the plate of the third 6AK5 is fed to the differentiating circuit formed by either capacitor C6, C7, C8 or C9, as selected by

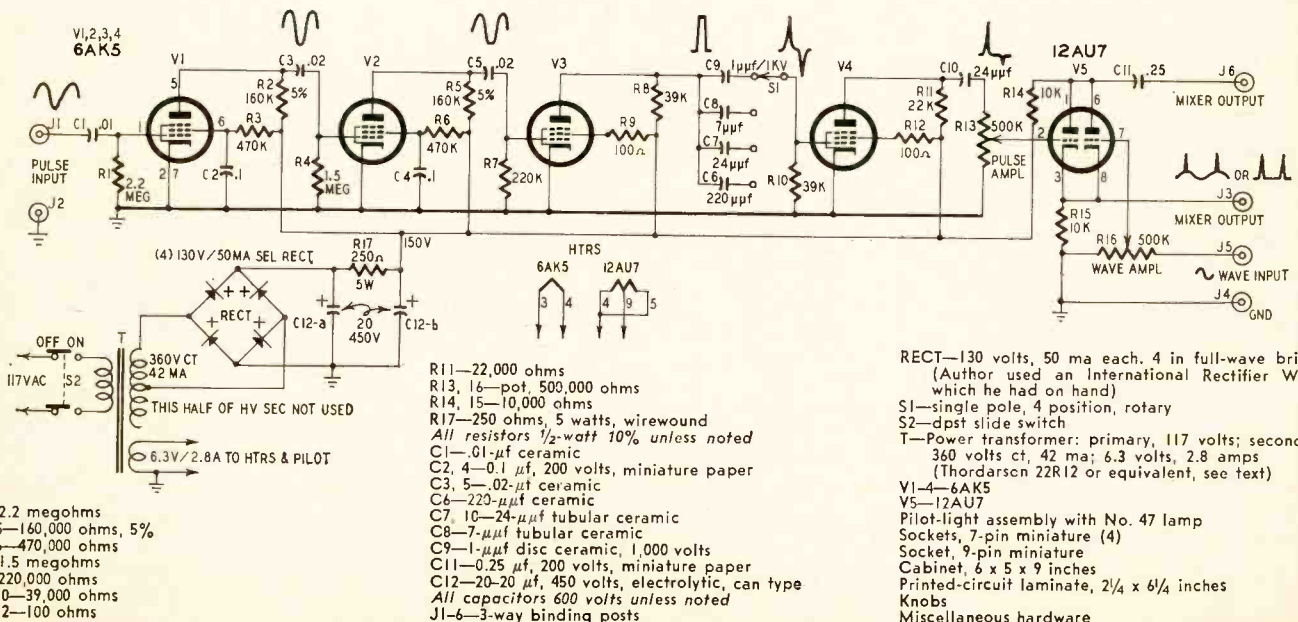
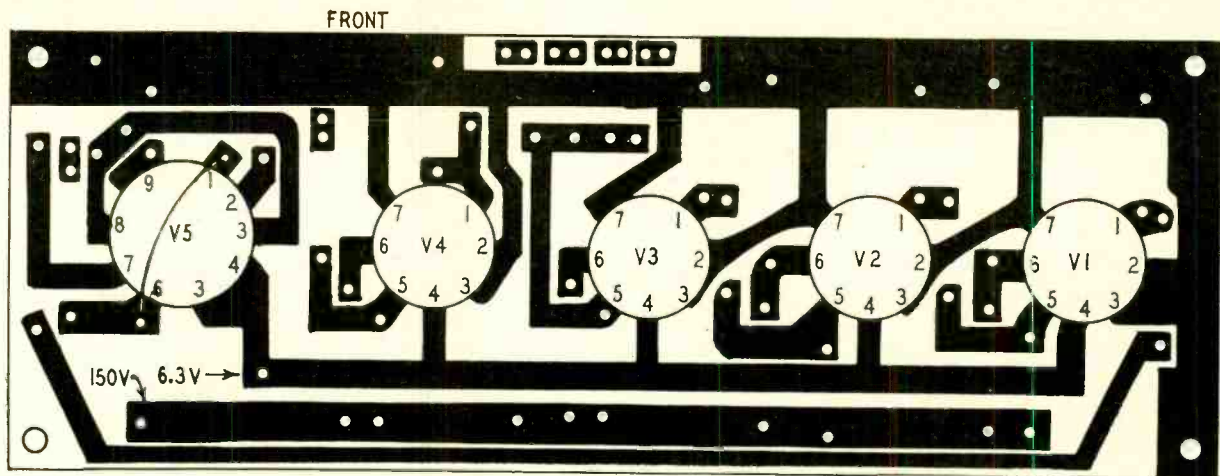

Fig. 5—Circuit of the 5-tube instrument.



BOTTOM VIEW - FULL SIZE
Fig. 6—Wiring side of printed-circuit board.

switch S1 and resistor R10. This differentiating network presents sharp positive and negative spikes to V4's grid. Because of the low plate voltage, the tube has a very low sharp-cutoff point and amplifies only the positive spikes efficiently, losing most of the negative spikes in the cutoff region. Switch S1 lets us select our pulse width. Were we to use the smallest capacitor on low-frequency square waves, we would find that attenuation had swallowed most of our pulse, or the pulse would be such a rapid excursion of the vertical trace that we could hardly detect it. However, for the higher frequencies we must reduce the time constant of the differentiating network. Thus switch S1 controls the pulse width. Since the pulses are essentially triangular, we also have a way to control the pulse slope—useful if we intend using the pulses for fast sweep.

After the differentiated pulse is amplified, it is applied to the attenuator for one half of the 12AU7 cathode follower-mixer. The other half is available for the original wave or any other

waveform we wish to mark. The result is that we also have control of the relative size of the spike superimposed on the waveform. In the cathode follower, the voltage swings at the plate and cathode are 180° out of phase or opposed in polarity. Thus we can have positive pulses from the cathode, and negative pulses from the plate if we need them.

The power supply is conventional. It must supply about 20 ma at 150 volts and be well filtered. But neither the voltage nor the regulation is critical. I used the full-wave bridge rectifier because I happened to have it in the junkbox. A simple full-wave or even half-wave power supply will perform adequately as long as approximately 150 volts dc is present.

Building the unit

Since the circuit is so well saturated that nothing in it is particularly critical, almost any construction method can be used. However, for the sake of simplicity and neatness, I used an etched-circuit board holding most of the parts. A full-scale reproduction of it

is shown in Fig. 6, while the layout of the components is shown in Fig. 7. The holes for the 6AK5 sockets are $\frac{5}{8}$ inch in diameter, while the 12AU7 socket requires a $\frac{3}{4}$ -inch hole.

As you can see there is one bridging wire from pin 1 to pin 6 of the 12AU7 socket. This ties the plates together.

The power supply is entirely separate from the circuit board and is mounted on the rear of the chassis (see photos). If you wish, the power supply need not be built in and some other external supply can be shared by this amplifier.

The tube sockets are inserted into the holes and their lugs bent toward the printed-wiring board and soldered. Be careful in soldering that not too much heat reaches the foil. It might separate. Also use only good-quality rosin-core solder. Any corrosive flux would soon eat through the thin foil of the laminate and cause trouble. There is some advantage in tinning the circuit lines after etching, giving a little more thickness and some chemical protection to the foil. However, this is not strictly necessary.

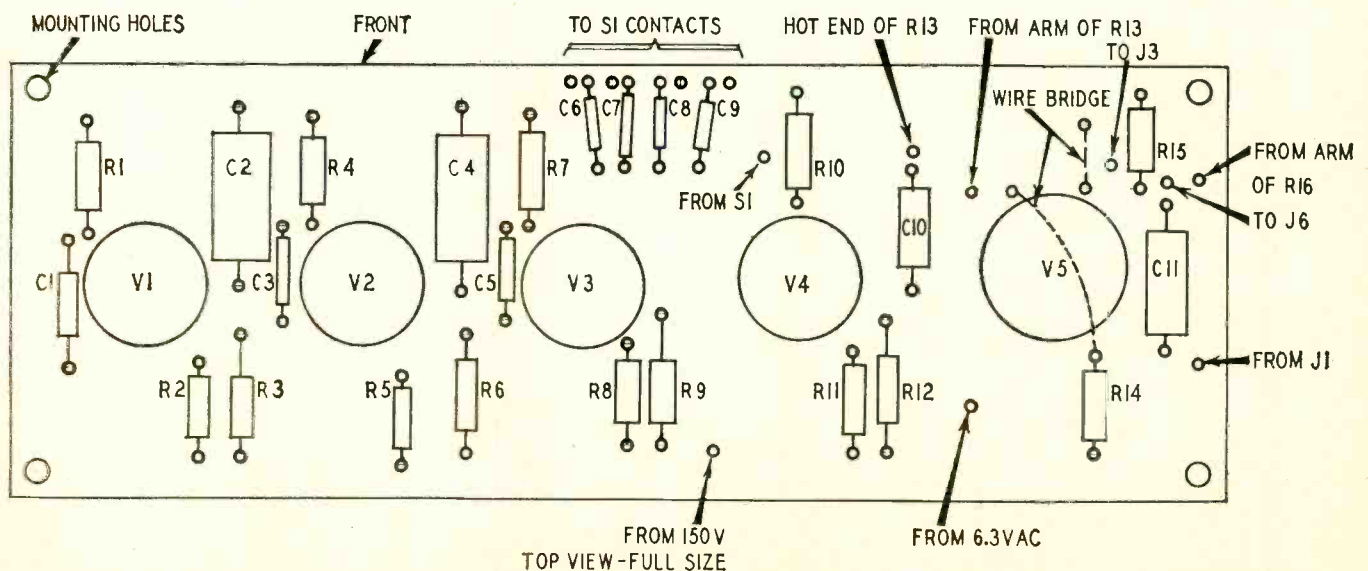

TOP VIEW - FULL SIZE
Fig. 7—Top view of printed-circuit board shows parts layout.

TEST INSTRUMENTS

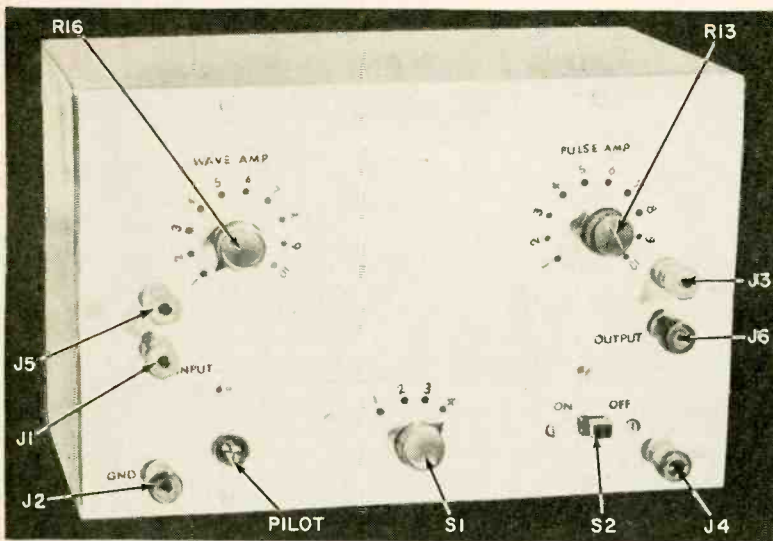

Front-panel layout of differentiating amplifier.

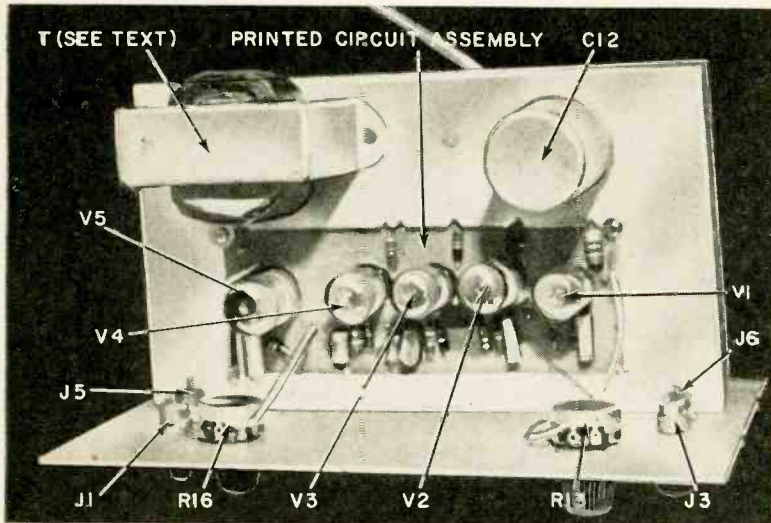

Top-chassis view of the completed unit.

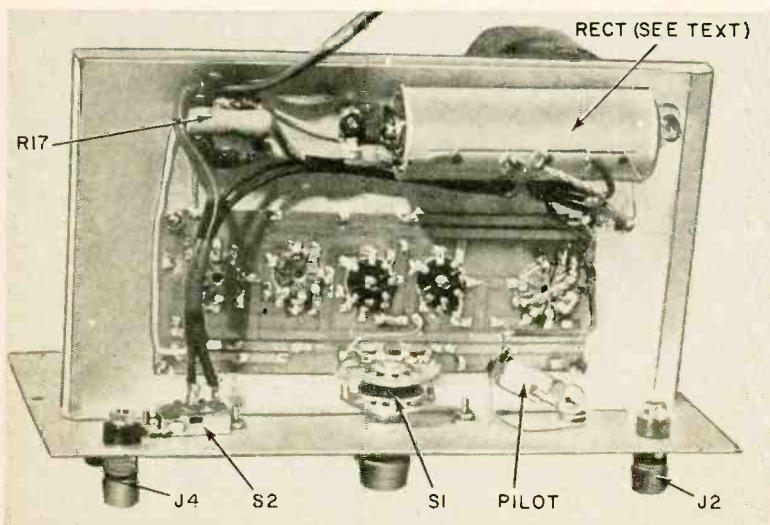

A look under the chassis shows power supply wiring.

Sharp-eyed readers will notice a slight difference in the circuit board in the photos and the template. The template is a slightly improved version, doing away with one additional crossover and one long wire to a potentiometer. The template has been carefully tested and is accurate.

The cabinet is an aluminum utility box 6 x 5 x 9 inches, and the chassis is bent from a piece of aluminum and attached to the front panel with two screws. There is not enough weight on the chassis to require extra bracing, if the screws are pulled up tightly.

Wire is used to connect the binding posts, the potentiometer and the pilot-light and power supply to the printed-circuit board. Short pieces of bare wire connect switch S1 to the circuit board. The circuit-board ends of these connections are clearly marked on the top-view diagram of the circuit board.

Metal rims on the tube sockets will not be needed and, if present, should be removed. The bent and soldered lugs will hold the sockets firmly in place. The circuit board has been designed to fit behind a rectangular hole, 2 1/8 x 6 1/8 inches, but with corners saved for mounting screws. Do not depend on the mounting screws to provide a solid ground connection. Several amps of heater current must be returned to ground. The best method is to connect all points to be grounded at a common location, such as the lugs on the filter capacitor can, for example.

The amplifier in use

You can use two of these amplifiers for accurate phase measurement, doing away with the electronic switch and connecting the pulse output of one amplifier to the wave input of the other to produce two sets of spikes. We must remember several points in this respect, however.

Phase difference is in essence a displacement in time. When we measure phase in a network or an amplifier, we measure how much one leads or lags the other. Any capacitance or inductance will introduce a certain amount of phase shift, depending on the relative time constants of the wave and the circuit. For very high frequencies, even a small capacitance will make a difference.

What we must then consider with great care in measuring phase is any possible phase shift introduced by our instruments. If we use an electronic switch with attenuators, we must make sure that no significant phase shift is introduced there. If we can set our attenuators at exactly the same point, and their construction is identical in all respects, we are reasonably safe. If any parallel stray capacitance is very small, we have little to worry about at low frequencies. Remember, however, that each input capacitor followed by a variable resistance of some sort makes a sort of phase shifter. The best policy is to make sure that the circuits we use to measure phase



CBS-HYTRON GOES ALL OUT FOR THE SERVICE-DEALER

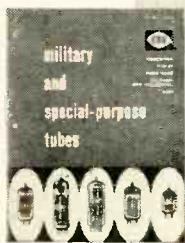
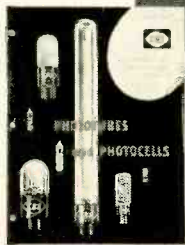

There's a reason for those awards to CBS-Hytron from dealer associations. CBS-Hytron has the welfare of the independent service-dealer at heart. And has proved it again and again: With a complete program promoting the independent service-dealer . . . including TV (Arthur Godfrey and Garry Moore) and national magazine advertising. With more CBS-Hytron time-effort-and-money-saving service tools. With scores of sales-promoting Business Builders. With two modern technical handbooks. With the most comprehensive and forward-looking line of replacement industrial tubes. With "inside" Tech Tips on tubes and semiconductors. With the original and most economical home-study Transistor Course. With a new aluminized 110-degree TV test tube. With illustrated technical talks for dealers.

With much more to come. And then tops them all with the advance-engineered tubes and semiconductors you can depend upon . . . products of the company that goes all out to serve the service-dealer most . . . CBS-Hytron.

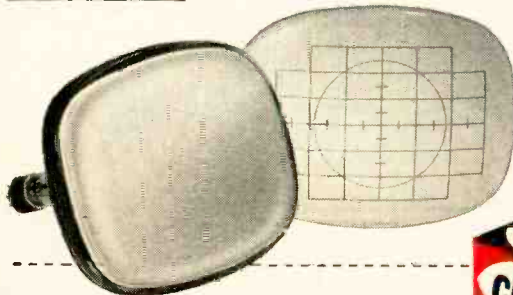
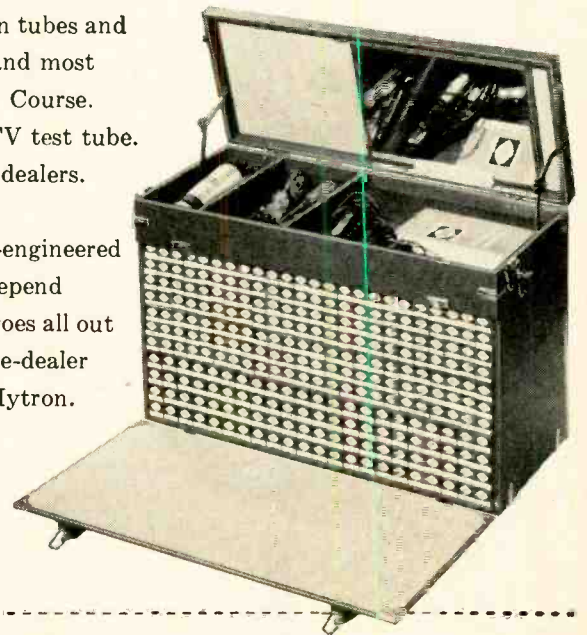

*More reliable products
through Advanced-Engineering*

CBS-HYTRON, Danvers, Massachusetts
A Division of Columbia Broadcasting System, Inc.

YOUR greatest FUTURE is in ENGINEERING

ELECTRONICS AERONAUTICS

The greatest need in the world's history for trained engineering brains is NOW. YOU can take advantage of this need to achieve success quickly. YOU can make big money—and have an unlimited future—if you decide NOW to GET INTO THE FIELD OF ENGINEERING.

The quickest and best way to do this is by studying at Northrop Institute. IN JUST TWO SHORT YEARS you can be employed by one of the leading electronics-aeronautics companies, at a very high starting salary.

Northrop has trained hundreds of young men just like yourself—normal, intelligent, ambitious—who are now making a name for themselves with such companies as: Autonetics Division of North American, Astronautics Division of Convair, Servomechanisms, Inc., Radioplane, Jet Propulsion Laboratories, and hundreds more.

So, whether your interest lies in the communications aspects of Electronics, automatic guidance systems, electronic computers; or control and safety equipment systems; whether you wish to specialize in piloted aircraft or missiles—Northrop Institute is the place to get your education.

Approved for Veterans



Northrop
Aeronautical Institute
An Accredited Technical Institute
1189 W. Arbor Vitae Street
Inglewood 1, California

Mail coupon for Free Catalog

NORTHROP AERONAUTICAL INSTITUTE

1189 W. Arbor Vitae Street, Inglewood 1, Calif.

Please send me immediately the Northrop catalog, employment data, and schedule of class starting dates. I am interested in:

- Electronic Engineering Technology
- Aeronautical Engineering Technology
- Aircraft Maintenance Engineering Technology
- Master Aircraft and Engine Mechanic
- Jet Engine Overhaul and Maintenance

Name Age

Address

City Zone State

Veterans: Check here for Special Veteran Training Information.

TEST INSTRUMENTS

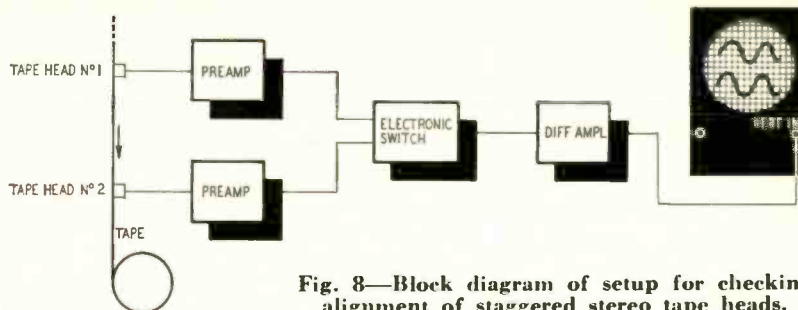

Fig. 8—Block diagram of setup for checking alignment of staggered stereo tape heads.

in two voltages are identical and do not introduce a phase difference of their own. We can quickly check this by applying the same voltage to both inputs of the electronic switch and noting the distance between pips, if any, at the desired attenuator settings. We must then, if there is a space, subtract this length from the measured phase shift. *This is a very important point and must not be overlooked if accurate measurements are to be made.*

Another important item is that the location of the pips can be affected by waveform. If we try to determine phase between a sine wave and a square wave, the phase difference appears a little greater if the square wave is leading and a little smaller if the sine wave leads. This occurs because the square wave saturates the amplifier just a little faster than the sine wave. If we have sufficient amplitude, say 1 volt or more, we have little to worry about, since the brute force of such a sine wave will saturate the amplifier so very nearly in the same time interval that not much difference can be seen. However, if the voltage is fairly low and the difference in waveform extreme, we would be better off using the ellipse method with 72 times the original frequency. Our ellipse will be very distorted, and the spaces between pips may appear unequal. But there we depend only on a counting process basically. However, a phase measurement between radically different waveforms is rare.

If you plan to use a chopper type electronic switch, rather than a synchronized type showing alternate traces, make very sure that the chopping frequency does not synchronize with the waveform to be measured or you may see a whole mess of pips at the chopper frequency. I have found that a chopper type switch is much harder to use for this type of work as only one with adequate blanking will give the nice clean traces which are

most useful. The synchronized type of course has no such problems.

To extend the frequency range of the instrument beyond 100 kc, reduce the time constants of the circuits. There will be some loss in gain, of course. Thus, if differentiating resistor R10 is made only 10,000 ohms and capacitors C6, C7, C8 and C9 even smaller, the upper frequency for sharp spikes will go up to at least 500 kc. But remember to increase the input voltage to make up for the decreased saturation of the circuits.

Where to use it?

I have found this amplifier to be a useful and inexpensive addition to my instrument collection, indispensable for designing phase-shift networks in the audio-frequency spectrum. But there are many other uses for it. Here are some of them:

In the audio field, phase measurement is important in the performance evaluation of audio amplifiers. These can be measured stage by stage or overall. The method is the same as indicated in Fig. 1, except that what is indicated as "phase-shift device" now becomes a stage of an amplifier or the whole amplifier.

Similarly we can check the phase shift in amplifiers and preamplifiers of a stereophonic sound system. Here phase shift is extremely important, since the stereo effect is partially a result of the phase difference of the sound at both ears. A significant phase difference in the amplifiers can cause a loss or an exaggeration of the stereo effect. In stereo we sometimes use staggered heads, particularly when the heads have been added to an existing recorder. The precise location of the head is vital. With the head displaced any significant amount more or less than the displacement of the tracks on the tape, some of the musicians would seem not to be keeping time. To use the amplifier for this work you first measure the phase shift of the

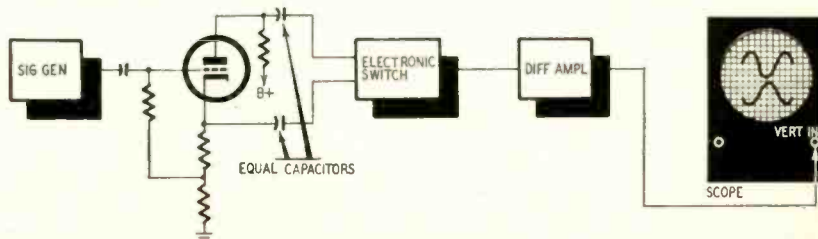

Fig. 9—Test setup for checking phase-splitter performance.

Quick
as a
Wink!



THE RIGHT CARBON CONTROL COMBINATION

There's no fuss, no muss, when it comes to getting the exact carbon control you want—when you ask for Clarostat. You get your choice of shaft—13 types to select from—and with just a light tap, the shaft is permanently attached. Also, pick your switch, and in a moment you have the exact combination you need. Ask your Clarostat distributor for the new, bigger, 1958 Catalog.

SHAFT

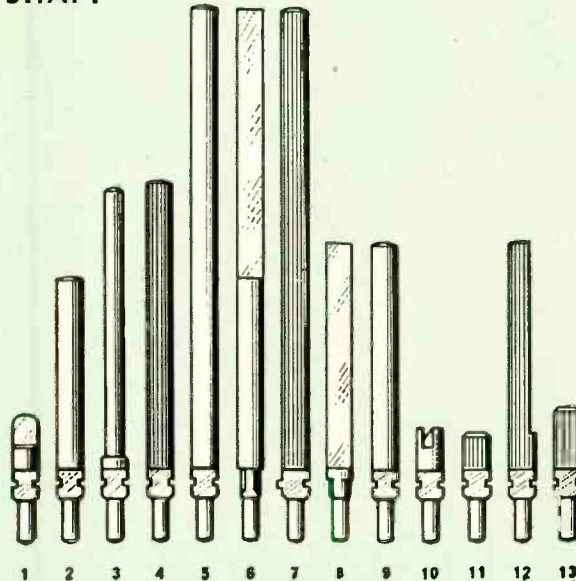

- 1 $\frac{3}{8}$ " long male for female fitting.
- 2 2" round shaft.
- 3 3" round shaft, $\frac{3}{16}$ " dia.
- 4 3" knurled split shaft.
- 5 5" round shaft.
- 6 5" flatted shaft.
- 7 5" knurled split shaft.
- 8 3" flatted shaft.
- 9 3" round shaft.
- 10 $\frac{1}{2}$ " double-flatted Philco-type shaft.
- 11 $\frac{1}{4}$ " fine knurled shaft.
- 12 3" knurled flatted shaft.
- 13 $\frac{1}{2}$ " fine knurled flatted shaft.

CONTROLS

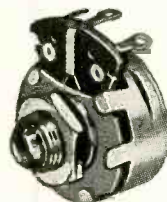

Series A 47: $\frac{1}{2}$ -watt, $\frac{1}{16}$ " diameter controls. 500 ohms to 10 megohms.

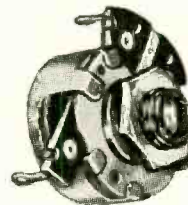

Series A 47F: $\frac{1}{2}$ -watt, $\frac{1}{16}$ " diameter controls, with taps located at 30%, 50% or 70% of rotation, depending upon resistance value. 50K to 3 megohms.

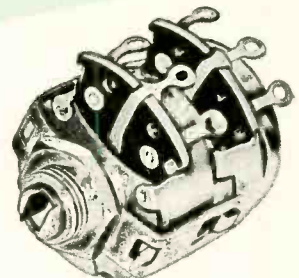

Series AD 47: $\frac{1}{2}$ -watt, $\frac{1}{16}$ " diameter dual controls for audio, radio, TV and industrial uses. Various taps available. 50K to 5 megohms.

SWITCH



Choice of five switch types including SPST and DPST, for various power ratings. UL approved

CLAROSTAT MFG. CO., INC.

Headquarters for RESISTORS, CONTROLS, and RESISTANCE DEVICES

DOVER, NEW HAMPSHIRE, U.S.A

In Canada: CANADIAN MARCONI CO., LTD., Toronto 17, Ont.

CDR ROTORS

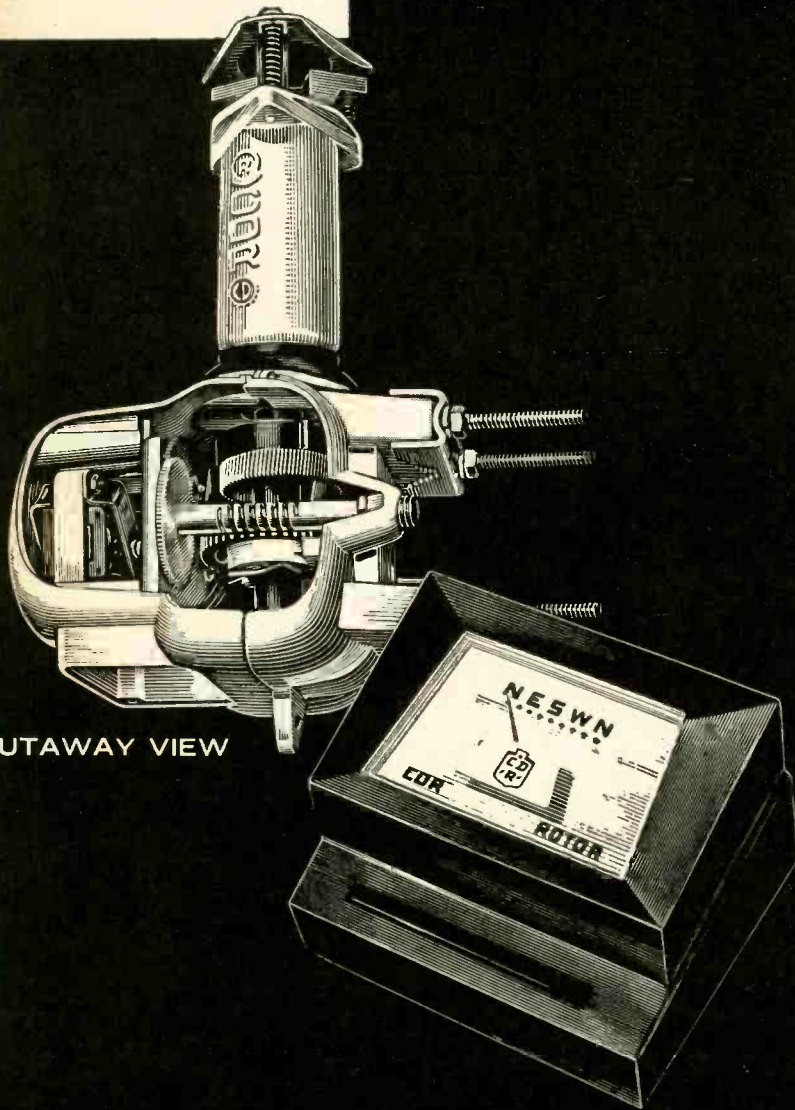

CUTAWAY VIEW

All new features

Completely designed from the ground up, CDR Model TR-15 and TR-16 Rotors have features never before available in the popular price range. Check these refinements and you'll see why: Quick mounting mast collet... speedy installation (no loose parts to assemble)... self-centering sawtooth clamps take masts up to 1½" O.D.... instant locking prevents drift... mechanical brake releases magnetically... instantly reversible... makes complete revolution in 45 seconds... meets JAN salt water test... great strength thrust bearing support... low weight... completely weather-sealed... fits standard towers... streamlined to reduce wind resistance... mahogany or blonde finish control box. Get full details today from your local CDR distributor.

CORNELL-DUBILIER ELECTRIC CORP.
South Plainfield, New Jersey

THE RADIART CORPORATION
Indianapolis, Indiana



CDR

Antenna Rotors

Old Hands at Dependability

TEST INSTRUMENTS

two preamps and then the total phase shift of heads and preamps together, using a test tape with a single sustained note. Such a test tape could be made on a recorder which is working satisfactorily. The lower the frequency of the test signal, the more accurate the measurement, since with high frequency you might be several integral cycles off. The setup for measuring tape-head displacement is illustrated in Fig. 8.

Another audio application would be checking the performance of phase splitters at various frequencies. Fig. 9 shows how.

In the radio and TV field there are a number of applications. One would be to check the phase shift of the networks used in single sideband. These must shift phase quite accurately to 90°. Video detectors are sometimes subject to phase distortion with frequency, and this of course would introduce picture distortion.

Industrial uses for phase measurements are many. Much industrial control is accomplished with thyratrons, and control of the firing period of thyratrons is almost universally accomplished with phase-shift networks. With the grid control voltage in phase with the plate voltage the tube will produce maximum average current and by shifting the phase this can be controlled. Accurate setting of the phase shift network could be very important.

Other industrial applications are the checking of phase of generators in parallel. Obviously paralleled generators which are not in phase will produce harmonics and lose efficiency. Phase detectors are used in many industrial equipments. Power-line electronic carrier relays use a phase-shift principle, and their setting is critical. Hundreds of miles of high-voltage lines may depend for protection on one such relay. Similarly in modern power plants the generators are now often paralleled automatically by electronic synchronizers. These instruments measure the phase shift of the generator voltages and, when at any point the shift becomes a certain preset minimum, closes the circuit breakers which put the generators on the line. Automatic synchronizers depend on phase detectors, which must be accurately adjusted.

Phase shift, where needed, can be produced by synchros or selsyns, and to calibrate these the phase measuring instrumentation can also be very useful. There are a multitude of other devices depending on accuracy of phase shift—echo sounders, for example. A time measurement of importance is the reverberation time of large halls or churches at various frequencies. This too can be measured as a phase shift.

Anyone having in his work or hobby a problem of phase or time measurement will find it much simpler if he uses the differentiating amplifier in combination with an oscilloscope and electronic switch.

END

TEST INSTRUMENTS

CAP-OHM-METER

Direct-reading unit for in-circuit testing of cathode bypass capacitors

By R. C. SANDISON

THE diagram shows the circuit of a capacitance meter which is accurate enough for all but the most exacting measurements. It can be readily assembled from junkbox parts and even if you do go out and buy the few necessary components, its cost is low. The only thing to make sure of is that the rheostat (R2) is a wirewound unit that covers a wide resistance range. I used an ancient one variable from about 2,000 to 100,000 ohms.

What the meter actually does is measure the capacitive reactance of the capacitor under test. The 117-volt ac

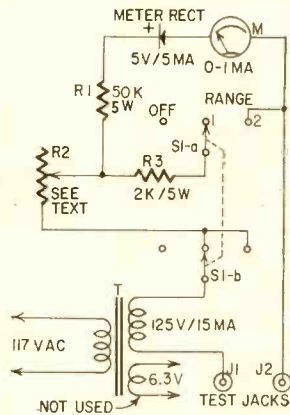

R1—50,000 ohms, 5 watts
R2—see text
R3—2,000 ohms, 5 watts
J1, J2—tip jacks
M—0-1-ma meter
RECT—meter type, 5 ma, 5 volts
S1—single-pole 3-position rotary
T—power transformer: primary, 117 volts; secondary, 125 volts, 15 ma; 6.3 volts, 600 ma
Case to suit
Miscellaneous hardware

Circuit of the useful instrument.

line provides a convenient 60-cycle frequency standard. The meter has two ranges: RANGE 1 covers .001 to 0.1 μ f and RANGE 2, .05 to 10 μ f, thereby including the more common sizes of capacitors for a quick check. Calibrate your scale by using good, high-tolerance capacitors for test measurements.

As the meter reads the capacitive reactance or effective resistance of the capacitor under test at 60 cycles, it can also be used as an ac ohmmeter. In this service only RANGE 1 is used. The resistance range may be calibrated with known resistors.

To make a quick check for shorts or opens in a cathode bypass capacitor without unsoldering, measure the resistance of the R-C combination first with this circuit and then with a dc ohmmeter. If both readings are exactly the same, the capacitor is obviously open or shorted. To make this a speedier test you can arrange your test leads so that they can be switched from one meter to the other. END

CORNELL-DUBILIER CAPACITORS

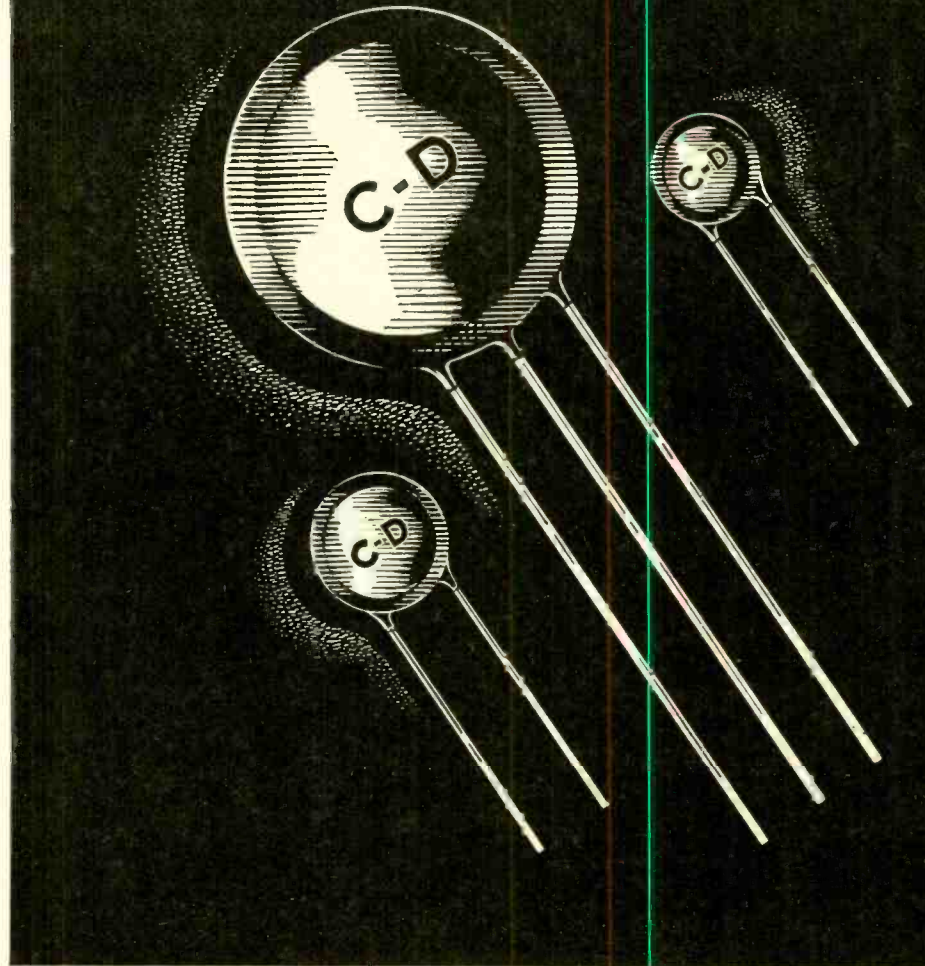

The Ceramics with the "worries" removed

If you want ease of mind, take a second look at C-D Ceramics... the Ceramics with the "MILLION DOLLAR BODY." Even if they were costly—which they're not—they would be the most economical replacements you could use. Because C-D Ceramics remain stable, won't melt, and are virtually immune to shorts and opens.

Besides, C-D Ceramics have a quality that can't be matched—because their manufacture, all under one roof, is rigidly supervised from raw materials to finished product.

Next time you need to replace a bypass or blocking capacitor, use a C-D Ceramic. They're available from your local C-D distributor in all the popular values and voltage ratings. Catalog 200D-3 is yours for the asking. Just write Cornell-Dubilier Electric Corporation, South Plainfield, New Jersey, Dept. REC-9.



CORNELL-DUBILIER CAPACITORS

Old Hands at Dependability

get ready for tomorrow... today

with **RCA COLOR TEST EQUIPMENT**

The alert service technician knows that his big future is not just around the corner—it's here today—in color-TV servicing! To get your share of this fast-growing market, you need the right kind of equipment. Get the right start! Make the right kind of investment with **RCA PROFESSIONAL COLOR TEST EQUIPMENT**



WR-46A VIDEO/DOT CROSSHATCH GENERATOR for making static and dynamic convergence adjustments in color-TV sets.

- Video output adjustable in amplitude on all patterns from 0 to 45 peak v across 4000-ohm load
- Vertical bars continuously adjustable from 10 to 25 (approx.) bars
- Cable connections on back of cabinet
- Reversible video output polarity
- Simple connections to TV receivers

WR-61B COLOR-BAR GENERATOR—essential for checking overall operation of color-TV receivers and for adjusting and troubleshooting color phasing and matrixing circuits.

- Amplitude of color subcarrier and color-burst signal adjustable from front-panel for checking color synclock action of set
- Both rf and video output available—video output has both "+" and "-" polarity
- RF output voltage, at least 0.01 volt peak to peak; video output voltage—at "Lo" connector, at least 0.25 volt peak to peak across 75 ohms; 8 volts peak to peak across 4700 ohms at "High" video output terminal



Write for technical literature describing these RCA Test Instruments and for the line flyer describing RCA's complete line of both color and black-and-white test instruments.

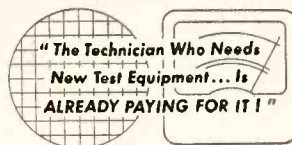

RADIO CORPORATION OF AMERICA

Electron Tube Division

Harrison, N. J.

RCA Commercial Engineering, Section 1-39-W
Harrison, New Jersey

Rush me the following literature on RCA professional Test Equipment!

- CD-57-6 (RCA WR-61B Color Bar Generator) 3F764 (RCA Test Equipment Line Flyer)
 CD-57-7 (RCA WR-46A Video/Dot Crosshatch Generator)

Name.....
Company.....
Address.....
City..... Zone..... State.....

Among other recent ARTSD activities: By unanimous vote, the association requested its licensing committee to draft a technician licensing bill, which will be proposed to city authorities. Also unanimously, the members who service auto radios agreed to a cooperative arrangement whereby they will set up pushbuttons for customers on the frequency of local radio station WMNI in exchange for spot announcements boosting the association.

LOW-PRESSURE SELL URGED

Next to the family doctor, the TV technician has the best "in" with the customer in his own own home—and he should take advantage of this position to do some selling. So said Lee Naylor, Western district sales manager of Channel Master Corp. in an address to the California State Electronics Association (CESA) convention in Fresno.

"Bring a portable radio along on the job," he suggested, "and let it play in the customer's home as the technician works." Charging that the service industry is not sufficiently sales-minded, he cited a survey by his own firm which indicated that 75% of service dealers never ran an antenna promotion; 90% did not follow up his company's national magazine advertising campaign—but those who did succeeded in making sales on 50% of their calls.

James Wakefield, Cardinal Electronics Service, Fresno, was elected CSEA 1958-59 president, succeeding H. Lawrence Schmitt of Burlingame, Calif.

Other new officers: Ray Warthen, Electronics Service Co., Vallejo, vice president, and Art Blumenthal, Art Blumenthal Co., Redwood City, secretary-treasurer.

NATESA ADDS 100TH

The National Alliance of Television & Electronics Service Associations (NATESA) recently added its 100th affiliate association—the Tri-State TV Association, with headquarters in Texarkana, Tex.—and kept right on growing, to a total of 104 local member groups. Nine local and regional groups were accepted as NATESA affiliates in a 30-day period.

GROUP EXPELS 7 FIRMS

Seven Kansas City TV service firms were expelled from Television Service Engineers (TSE) of Kansas City on the grounds of "breach of ethics" and violation of "the spirit of the association and its bylaws." The expulsion, voted by a majority of the TSE membership, was followed by suspension of the same firms from Television & Electronic Service Association of Missouri.

The seven companies reportedly were associated with a parts distributor in a venture called "Courtesy TV" which advertised free tube testing in the home. **END**

new Devices



COMMUNITY TV AMPLIFIER, model SPA. Rated at 20 volts output into 75-ohm load, equaling more than 5 watts at bandwidth of over 6 mc. For any

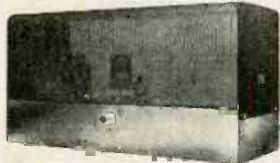

vhf channel. Designed for continuous commercial service. Input of 1 volt required.—Seg Electronics Co. Inc., 1778 Flatbush Ave., Brooklyn 10, N. Y.

RECEIVER COIL KIT, MS-450. For subminiature transistor broadcast receiver circuits. 3 455-kc shielded if coils and oscillator coil, each only 19/32 inch above chassis and 3/8 inch in



diameter, ferrite loop antenna plus miniature 2-gang Poly-Vari-Con tuning capacitor. MS-440 has same coils less capacitor.—Lafayette Radio, 165-08 Liberty Ave., Jamaica 33, N. Y.

TRANSISTOR VIBRATOR REPLACEMENT, Univistor line. Direct replacements for mechanical vibrators. 2 germanium power transistors make up



switching element, in conjunction with existing vibrator transformer, to convert dc to ac. Operating life more than 10,000 hours, compared with 400-500-hour vibrator average.—Universal Transistor Products Corp., 17 Brooklyn Ave., Westbury, N. Y.

FLYBACK TRANSFORMERS. Model EFR 134 replaces Bendix 265075-1; EFR 135 replaces



Bendix 265078-3—Rogers Electronic Corp., 49 Bleecker St., New York 12, N. Y.

TUNABLE MOBILE RADIOS. Model M-40 (shown) operates

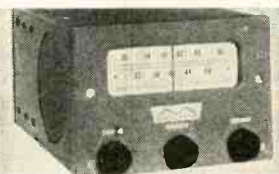

in 30-50-mc band, model M-160 in 152-174-mc band. Both have double-conversion tuned rf stages, 2-mv sensitivity, built-in adjustable squelch, 4-inch speaker, sliderule dial.—Monitoradio Div., I.D.E.A. Inc., 7900 Pendleton Pike, Indianapolis.

VHF CONVERTER, model VHF-126. Extends range of any com-

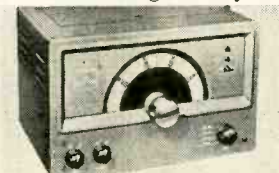

munications receiver through 6-, 2- and 1 1/4-meter amateur bands. Built-in power supply. Utilizes low-frequency if stage of ham receiver. Fast and micrometer tuning. Direct reading in megacycles.—Radio Manufacturing Engineers Inc., Div. of Electro-Voice Inc., Buchanan, Mich.

FM-AM TUNER, models FA-11 and FA-12. FM multiplex jack.



Sensitivity 5 μ v for 30-db quieting on FM, 200 μ v/m for 20-db signal-to-noise ratio on AM. FM maximum deviation sensitivity 5 μ v. Afc. Tuning meter for AM and FM. Folded-dipole FM antenna, ferrite-rod AM antenna. Cathode-follower audio outputs. Maximum 1 1/2% harmonic distortion, less than 2% IM.—General Electric Co., Specialty Electronic Components Dept., W. Genesee St., Auburn, N. Y.

CABINETS AND ENCLOSURES. New line includes



equipment cabinets and speaker enclosures in variety of finishes. Leatherette-covered console CBC-8-12 has swivel base (shown)—Wellcor, Inc., 1214 N. Wells St., Chicago, Ill.

SPEAKER SYSTEMS, Wharfedale. Small-sized units adaptable to stereo room arrangements. W/AF/2 (shown) contains Super 12/FS/AL 12-inch speak-

The specs are the proof...now your best buy in ham equipment is



New 90-WATT CW TRANSMITTER #720
KIT \$79.95 WIRED \$119.95

Conservative, highly efficient design plus stability, safety, and excellent parts quality. Covers 80 thru 40, 20, 15, 11, 10 meters (popular operating bands) with one knob band-switching. 6146 final amplifier for full "clean" 90W input, protected by clamper tube circuit. 6CL6 Colpitts oscillator, 6AQ5 clamper, 6AQ5 buffer-multiplier, GZ34 rectifier. "Novice limit" calibration on meter keeps novice inside the FCC-required 75W limit. No shock hazard at key. Wide range, hi-efficiency pi-network matches antennas 50 to 1000 ohms, minimizes harmonics. EXT plate modulation terminals for AM phone modulation with 65W input. Excellent as basic exciter to drive a power amplifier stage to maximum allowable input of 1KW. Very effective TVI suppression. Ingenious new "low silhouette" design for complete shielding and "living room" attractiveness. Finest quality, conservatively rated parts, copper-plated chassis, ceramic switch insulation. 5" H, 15" W, 9 1/2" D.



NEW UNIVERSAL MODULATOR-DRIVER #730
KIT \$49.95 WIRED \$79.95 Cover E-5 \$4.50

Superb, truly versatile modulator at low cost. Can deliver 50 watts of undistorted audio signal for phone operation, more than sufficient to modulate 100% the EICO #720 CW Transmitter or any xmitter whose RF amplifier has a plate input power of up to 103W. Multi-match output xmr matches most loads between 500-10,000 ohms. Unique over-modulation indicator permits easy monitoring, precludes need for plate meter. Low level speech clipping and filtering with peak speech frequency range circuitry. Low distortion feedback circuit, premium quality audio power pentodes, indirectly heated rectifier filament. Balance & bias adjust controls. Inputs for crystal or dynamic mikes, phone patch, etc. Excellent deluxe driver for high-power class B modulation. ECC83/12AX7 speech amplifier, 6AL5 speech clipper, 6AM8 amplifier driver, 2-EL34/6CA7 power output, EM84 over-modulation indicator, GZ34 rectifier. Finest quality, conservatively rated parts, copper-plated chassis. 6" H, 14" W, 8" D.

NEW GRID DIP METER #710
KIT \$29.95 WIRED \$49.95 including complete set of coils for full band coverage.

Exceptionally versatile. Basically a VFO with micro-ammeter in grid; determines freq. of other osc. or tuned circuits; sens. control & phone jack facilitate "zero beat" listening. Excellent absorption wave meter. Ham uses: pre-tuning & neutralizing xmitters, power indication, locating parasitic osc., antenna adj., correcting TVI, de-bugging with xmitter power off, determining C.L.Q. Servicing uses: alignment of filters, IF's; as sig. or marker gen. Easy to hold & thumb-tune with 1 hand. Continuous 400 kc - 250 mc coverage in 7 ranges, pre-wound 0.5% accurate coils. 500 ua meter movement. 6AF4(A) or 6T4 Colpitts osc. Xmr-operated sel. rect. 2 1/4" H, 2 1/2" W, 6 1/2" L. Satin deep-etched aluminum panel; grey wrinkle steel case.



IN STOCK! Compare & take them home — right "off the shelf"—from 1900 neighborhood EICO dealers — no mail delays, no high penalty freight costs. For free catalog mail coupon. Over 1 MILLION EICO instruments in use throughout the world. Add 5% in the West!

Send for FREE CATALOG now **C-9**
EICO, 33-00 Northern Blvd., L.I.C. 1, N. Y.
Show me HOW TO SAVE 50% on 60 models of top-quality equipment (in box I have checked here: HAM GEAR HI-FI TEST INSTRUMENTS. Send FREE literature and name of EICO dealer.

NAME.....
ADDRESS.....
CITY..... STATE.....

See EICO's Hi-Fi and Test Equipment ads on Pages 29 and 30.



er, *Super 3* tweeter with balancing control; 36% x 23 x 15% inches. Enclosure *AF/12/Cab* available separately. *W/AF/1* is 30 x 17 x 12 inches, with *W10/FSB* 10-inch speaker, tweeter, balancing control. Enclosure is *AF/10/Cab*.—British Industries Corp., 80 Shore Rd., Pt. Washington, N. Y.

WOOFERS, Tempo. Model *W12K508* is 12-inch speaker with 10-ounce Alnico V magnet, 1 1/4-inch voice coil, 15-watt power-handling capacity; 4,000-cycle rolloff, 50-cycle resonance. Model *W12M608*: 12-inch, 20-



ounce magnet, 1 1/2-inch voice coil, 25-watt capacity, rolloff at 3,000 cycles, 45-cycle resonance. Model *W15M608*; 15-inch, with 20-ounce magnet, 1 1/2-inch voice coil, 25-watt power capacity, 2,000 cycle rolloff, 40-cycle resonance.—Oxford Components Inc., 556 W. Monroe, Chicago.

LOUDSPEAKER SYSTEM, model Six. Requires slightly more than 1 foot floor space; 23 1/2 inches high. 12-inch acous-

tic suspension woofer, cone type direct-radiator tweeter.—



KLH Research & Development Corp., 30 Cross St., Cambridge 39, Mass.

AMPLIFIER-SPEAKER, Stereo Companion model 560. Designed for conversion of existing Fisher phono and radio-phono units.



Volume, bass and treble adjustments controlled from panel on main unit. Peak power 32 watts. 3-speaker system.—Fisher Radio Corp., 21-21 44 Dr., Long Island City 1, N. Y.

PACKAGED HI FI, model AUV-36. One of a line of hi-fi packages. For use as basic system or stereo conversion. Fiberglass-loaded cabinet, Jensen speaker



system, 10-watt Bell amplifier.—Universal Woodcrafters Inc., La Porte, Ind.

STEREO AMPLIFIER-PRE-AMP, Eico model HF81, kit or wired form. Separate low- and high-level inputs in each channel, including FM multiplex and auxiliary inputs. Ganged level controls and separate balance control. Williamson type push-pull EL84 power amplifiers in



each channel. Total output power 28 watts continuous (14 watts each channel), 56 watts peak. Response ±0.5 db, 10-100,000 cycles at 2 watts. 10 tubes.—Electronic Instrument Co. Inc., 33-00 Northern Blvd., Long Island City 1, N. Y.

MONAURAL-STEREO PRE-AMP kit. Monaural model SP-1 is basic preamplifier, which may be converted to stereo without



rewiring by using model *C-SP-1* conversion kit. Complete model *SP-2* (stereo) has 12 inputs, 6 on each channel, with input level controls. 6 dual-concentric con-

trols include 2 bass, 2 treble, 2 volume level, 2 loudness controls, scratch filter, 4-position function switch. EF86 tubes used in input. Two cathode-follower outputs. Remote balance control with 20 feet of cable. 2 printed-circuit boards and encapsulated circuits.—Heath Co., Benton Harbor, Mich.

STEREO CONTROL KIT, Dyna-kit DSC1. May be added to pair of preamps or amplifiers. Dual volume control, balance control, loudness compensation with disabling switch, channel-reversing switch, dual tape-monitor switch.



Auxiliary "blend" control permits mixing stereo channels in controllable proportion.—Dyna-co Inc., 617 N. 41 St., Philadelphia 4, Pa.

STEREO CONVERSION for tape recorders. *Stereo-Kit SK-100* converts monaural recorders for reproduction of standard 2-channel stereo tapes; *SK-50*

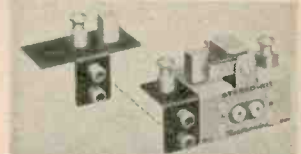

New Autospeed Changer



ASR-433 Stereo Amplifier—Selected for display at the Vienna International Fall Fair.



THE NEW STROMBERG-CARLSON COMPONENTS

integrity in music

Integrity in Music, as applied to high fidelity components, means reproduction which adds nothing to, or takes nothing from, the original performance.

Our choice of this slogan is no accident. Just as your purchase of a component system is not a casual investment, our attitude toward the manufacture of components is very serious. Each piece of gear must reflect the highest possible achievement of engineering, production, and musical skill. Yes, musical skill—because the guiding minds of the Stromberg-Carlson component group are those of electronic and acoustic engineers with extensive musical training.

The musical sound of our new components was the final critical test before they were made available to you.

We will be glad to submit our specifications to your critical judgment.

"There is nothing finer than a Stromberg-Carlson"

STROMBERG-CARLSON SC | GD

A DIVISION OF GENERAL DYNAMICS CORPORATION

1478 N. Goodman St. • Rochester 3, N. Y.

Electronic and communications products for home, industry and defense...

See your dealer or write to us for full data on our complete new line of Amplifiers, Speakers, Speaker Systems, Enclosures and Program Sources.

BUILD 16 RADIO

CIRCUITS AT HOME

with the New Deluxe 1959

PROGRESSIVE RADIO "EDU-KIT"

only

\$22⁹⁵

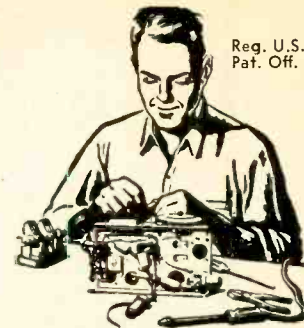

Reg. U.S. Pat. Off.

A COMPLETE RADIO COURSE

Now Also Includes

- ★ TRANSMITTER
- ★ SIGNAL TRACER
- ★ SIGNAL INJECTOR
- ★ CODE OSCILLATOR
- ★ No Knowledge of Radio Necessary
- ★ No Additional Parts or Tools Needed
- ★ EXCELLENT BACKGROUND FOR TV
- ★ School Inquiries Invited
- ★ Attractively Gift Packed

NO NEED TO SPEND HUNDREDS OF DOLLARS FOR A RADIO COURSE

The "Edu-Kit" offers you an outstanding PRACTICAL HOME RADIO COURSE at a rock-bottom price. Our Kit is designed to train Radio & Electronics Technicians, making use of the most modern methods of home training. You will learn radio theory, construction practice and servicing.

You will learn how to build radios, using regular schematics; how to wire and solder in a professional manner; how to service radios. You will work with the standard type of punched metal chassis as well as the latest development of Printed Circuit chassis.

You will learn the basic principles of radio. You will construct, study and work with RF and AF amplifiers and oscillators, detectors, rectifiers, test equipment. You will learn and practice code, using the Progressive Code Oscillator. You will learn and practice trouble-shooting, using the Progressive Signal Tracer, Progressive Signal Injector, Progressive Dynamic Radio & Electronics Tester and the accompanying instructional material.

You will receive training for the Novice, Technician and General Classes of F.C.C. Radio Amateur Licenses. You will build 16 Receiver, Transmitter, Code Oscillator, Signal Tracer and Signal Injector circuits, and learn how to operate them. You will receive an excellent background for Television.

Absolutely no previous knowledge of radio or science is required. The "Edu-Kit" is the product of many years of teaching and engineering experience. The "Edu-Kit" will provide you with a basic education in Electronics and Radio, worth many times the complete price of \$22.95. The Signal Tracer alone is worth more than the price of the entire Kit.

THE KIT FOR EVERYONE

You do not need the slightest background in radio or science. Whether you are interested in Radio & Electronics because you want an interesting hobby, a well paying business or a job with a future, you will find the "Edu-Kit" a worth-while investment.

Many thousands of individuals of all ages and backgrounds have successfully used the "Edu-Kit" in more than 79 countries of the world. The "Edu-Kit" has been carefully designed, step by step, so that you cannot make a mistake. The "Edu-Kit" allows you to teach yourself at your own rate. No instructor is necessary.

PROGRESSIVE TEACHING METHOD

The Progressive Radio "Edu-Kit" is the foremost educational radio kit in the world, and is universally accepted as the standard in the field of electronics training. The "Edu-Kit" uses the modern educational principle of "Learn by Doing." Therefore you construct, learn schematics, study theory, practice trouble-shooting—all in a closely integrated program designed to provide an easily-learned, thorough and interesting background in radio.

You begin by examining the various radio parts of the "Edu-Kit." You then learn the function, theory and wiring of these parts. Then you build a simple radio. With this first set you will enjoy listening to regular broadcast stations, learn theory, practice testing and trouble-shooting. Then you build a more advanced radio, learn more advanced theory and techniques. Gradually, in a progressive manner, and at your own rate, you will find yourself constructing more advanced multi-tube radio circuits, and doing work like a professional Radio Technician.

Included in the "Edu-Kit" course are sixteen Receiver, Transmitter, Code Oscillator, Signal Tracer, and Signal Injector circuits. These are not unprofessional "breadboard" experiments, but genuine radio circuits, constructed by means of professional wiring and soldering on metal chassis, plus the new method of radio construction known as "Printed Circuitry." These circuits operate on your regular AC or DC house current.

A COMPLETE RADIO COURSE—NOTHING ELSE TO BUY

You will receive all parts and instructions necessary to build 16 different radio and electronics circuits, each guaranteed to operate. Our Kits contain tubes, tube sockets, variable, electrolytic, mica, ceramic and paper dielectric condensers, resistors, tie strips, coils, hardware, tubing, punched metal chassis, Instruction Manuals, wire, solder, etc.

In addition, you receive Printed Circuit materials, including Printed Circuit chassis, special tube sockets, hardware and instructions. You also receive a useful set of tools, a professional electric soldering iron, and a self-powered Dynamic Radio & Electronics Tester. The "Edu-Kit" also includes Code Instructions and the Progressive Code Oscillator. In addition to F.C.C.-type Questions and Answers for Radio Amateur License training. You will also receive lessons for servicing with the Progressive Signal Tracer and the Progressive Signal Injector, a High Fidelity Guide and a Quiz Book. You receive all parts, tools, instructions, etc. There is nothing else to buy. Everything is yours to keep.

FREE EXTRAS

- SET OF TOOLS
- SOLDERING IRON
- ELECTRONICS TESTER
- TESTER INSTRUCTION MANUAL
- HIGH FIDELITY GUIDE
- QUIZZES
- TELEVISION BOOK
- RADIO TROUBLE-SHOOTING BOOK
- MEMBERSHIP IN RADIO-TV CLUB
- CONSULTATION SERVICE
- FCC AMATEUR LICENSE TRAINING
- PRINTED CIRCUITRY
- PLIERS-CUTTERS
- ALIGNMENT TOOL
- CERTIFICATE OF MERIT
- VALUABLE DISCOUNT CARD
- WRENCH SET

SERVICING LESSONS

You will learn trouble-shooting and servicing in a progressive manner. You will practice repairs on the sets that you construct. You will learn symptoms and causes of troubles in home, portable and car radios. You will learn how to use the professional Signal Tracer, the unique Signal Injector and the dynamic Radio & Electronics Tester. While you are learning in this practical way, you will be able to do many a repair job for your friends and neighbors, and charge fees which will far exceed the price of the "Edu-Kit." Our Consultation Service will help you with any technical problems you may have.

J. Stataitis, of 25 Poplar Pl., Waterbury, Conn., writes: "I have repaired several sets for my friends, and made money. The "Edu-Kit" paid for itself. I was ready to spend \$240 for a Course, but I found your ad and sent for your Kit."

FROM OUR MAIL BAG

Ber Valerio, P. O. Box 21, Magna, Utah: "The Edu-Kits are wonderful. Here I am sending you the questions and also the answers for them. I have been in Radio for the last seven years, but like to work with Radio Kits, and like to build Radio Testing Equipment. I enjoyed every minute I worked with the different kits: the Signal Tracer works fine. Also like to let you know that I feel proud of becoming a member of your Radio-TV Club."

Robert L. Shuff, 1531 Monroe Ave., Huntington, W. Va.: "Thought I would drop you a few lines to say that I received my Edu-Kit, and was really amazed that such a bargain can be had at such a low price. I have already started repairing radios and phonographs. My friends were really surprised to see me get into the swing of it so quickly. The Troubleshooting Tester that comes with the Kit is really swell, and finds the trouble, if there is any to be found."

Unconditional Money-Back Guarantee

The Progressive Radio "Edu-Kit" has been sold to many thousands of individuals, schools and organizations, public and private, throughout the world. It is recognized internationally as the ideal radio course.

By popular demand, the Progressive Radio "Edu-Kit" is now available in Spanish as well as English.

It is understood and agreed that should the Progressive Radio "Edu-Kit" be returned to Progressive "Edu-Kit" Inc. for any reason whatever, the purchase price will be refunded in full, without quibble or question, and without delay.

The high recognition which Progressive "Edu-Kits" Inc. has earned through its many years of service to the public is due to its unconditional insistence upon the maintenance of perfect engineering, the highest instructional standards, and 100% adherence to its Unconditional Money-Back Guarantee. As a result, we do not have a single dissatisfied customer throughout the entire world.

- Send "Edu-Kit" Postpaid. I enclose full payment of \$22.95.
- Send "Edu-Kit" C.O.D. I will pay \$22.95 plus postage.
- Send me FREE additional information describing "Edu-Kit."

Name _____

Address _____

PROGRESSIVE "EDU-KITS" INC.

1186 Broadway, Dept. 144G, Hewlett, N.Y.

NEW DEVICES (Continued)

for 4-channel tapes. Also available *PL-100* playback amplifier for second sound channel, *RA-100* recording amplifier for stereo recording using *Stereo-Kit* conversion, *EK-100 Erase-Kit* for 2-channel *Stereo-Kit*, *EK-50* for 4-channel.—Nortronics Co. Inc., 1011 S. 6 St., Minneapolis 4, Minn.

BASIC AMPLIFIER, *Knight* model *KN-632*. For use with any tuner or preamp having volume and tone controls. 32 watts. Variable damping adjust-

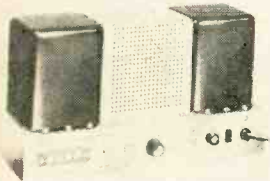

ment for optimum performance with any speaker system. Output taps of 4, 8 and 16 ohms. Input level control. Maximum output delivered from 0.7-volt input. Response ± 0.5 db from 20 to 40,000 cycles at full output. Harmonic distortion less than 0.5% at mid-frequencies, maximum 1.5% at full output.—Allied Radio Corp., 100 N. Western Ave., Chicago 80, Ill.

STEREO PREAMPLIFIER, model *130*. Front panel controls: selector switch, stereo tape monitor, scratch filter, rumble filter, phase reversal switch, loudness-volume switch, input selector, stereo selector, bass and treble controls, stereo balance, loudness control. Phase reverse switch permits use of

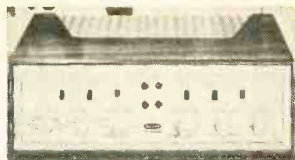

vertical transcription recordings. Third-channel output permits use of central channel. Input sensitivity 1.5 mv.—H. H. Scott Inc., 111 Powdermill Rd., Maynard, Mass.

L-C TUNERS. Line of variable-tuned circuits combines variable inductance and capacitor in stable glass cylinder. Inductor winding acts as capacitor plates. Movement of piston in cylinder changes inductance and capacitance. *L-C J1A* (shown) has self-resonating frequency range



of 450-1,000 mc; loaded tuners resonate from 80 to 300 mc, according to load.—JFD Electronics Corp., 6101 16 Ave., Brooklyn 4, N. Y.

PHONO NEEDLE LINE, *Full-Fidelity*. Covers all *Philco* and competitive models. Includes osmium, jewel- and diamond-tipped needles, each packed in newly designed plastic case. Compact jewel type merchandiser contains fastest-selling needles and cartridges. 24-page catalog for visual identification

of all needle types and part-number comparison with manu-



facturers.—*Philco Corp.*, Accessory Div., C & Westmoreland Sts., Philadelphia 34, Pa.

STEREO CARTRIDGE, *CD* model *SC-1*. Dual ceramic unit

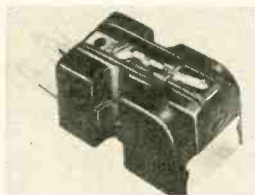

has single diamond stylus for all speeds and types of monaural and stereo discs. Frequency response 20-20,000 cycles.—*CBS-Hytron*, Danvers, Mass.

STEREO CARTRIDGE. Four-terminal turnover type. Similar



in size to monaural *TX-88 Superfluid Duo-Clip* stylus assembly.—*Ronette Acoustical Corp.*, 190 Earle Ave., Lynbrook, N. Y.

CERAMIC MICROPHONE, model *CM-10*. Covers 50-13,000 cycles flat within ± 3 db. Budget-priced unit has sensitivity of 57 db below 1 volt per microbar.



Omnidirectional, high impedance. With 7-foot shielded cable.—*Sonotone Corp.*, Elmsford, N. Y.

MINIATURE MIKE, *D801*. Dynamic type, designed for concealed use. Response 250-6,000 cycles, output level -52 db



(-46 db at voice frequencies). 1 5/32 (diameter) x 63/64 inch.—*American Microphone Manufacturing Co.*, 412 S. Wyman St., Rockford, Ill.

TRANSISTOR TESTER, model *150*. Self-contained mercury-cell power supply. Tests all transistors and diodes, power transistors at high currents. Measures junction transmitter beta, accuracy within 5%. Built-in ac generator contains 1-ke transistor oscillator with buffer amplifier. Two beta scales read 0-50 and 0-250. Leakage current read directly on meter scale, 0-2,

NEW IMPROVED SENCORE LC3 Leakage Checker

Another Sencore Time-Saver

Check these outstanding New Features

Now — For the first time...

- Checks 130 different tube types — more than any other "grid circuit" type checker. Includes UHF and latest type tubes.
- Checks picture tubes without removing tube from cabinet or chassis.
- New Roll Chart prevents obsolescence — just dial the tube type and save time. Chart is easily replaced at no extra cost.
- Dynamic Filament checks including heater to cathode leakage & shorts — no need for a second filament tester.
- Two spare preheating sockets to cut down testing time.
- Capacitor checks simplified.

The LC3 provides all these new improved features in addition to those employed in earlier leakage or "grid circuit" testers. A must for any TV service technician.

RECOMMENDED SERVICE INSTRUMENTS CORP. In stock at your local parts distributor

171 Official Rd • Addison, Ill.

28.95 Dealer Net Really Whips Tough Dogs

Cut out this ad now for further information

is RADIC AND TV

"I just dropped in to ask if you sell JENSEN NEEDLES."

ANOTHER FIRST FROM *Almo* WORLD FAMOUS *Regency*

TRANSISTOR RADIO

SUB-MINIATURE PRIVATE EAR VEST-POCKET ALL-TRANSISTOR

PORTABLE

Now only! **\$14.95** COMPLETE WITH BATTERIES

MODEL XR-2A

The smallest real transistor radio—not as large as a cigarette pack—listen any time, anywhere without disturbing anyone. Weighs less than a hearing aid—perfect for spectators at sports, night owls, students in libraries, etc.—featherweight earphone plays for you alone. Mandarin Red. Operates hundreds of hours on 2 fresh Penlight Batteries.

CALL, WRITE OR COME INTO THE *Almo* RADIO CO. 913 ARCH ST., PHILA., PENNA.



0-50 and 0-200 μ a. Tests can be made at collector voltage of 1.34, 2.68, 4.02 or 5.36.—**B&K Manufacturing Co.**, 3726 N. Southport Ave., Chicago 13, Ill.

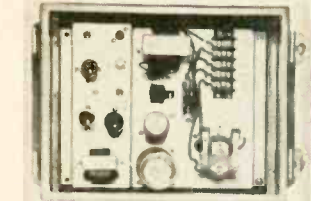

RADIO CONTROL SYSTEMS for commercial, industrial and residential use. Transmitter, receiver, antennas and hardware. Range from a few feet to more than mile. Available for 117-volt ac, 6- or 12-volt dc operation. Multiple-channel units available with up to 12 non-interfering channels.—**Perma-Power Co.**, 3100 N. Elston Ave., Chicago, Ill.

TEFLON TUBING. For laboratory and servicing applications. Will not melt when used near solder joints, remaining stable at temperatures from -450° to 500° F. 8 sizes, .022 to 0.106 inch ID in 5- or 10- and 100-foot spools. 3 colors.—**Waisco**

Just Out

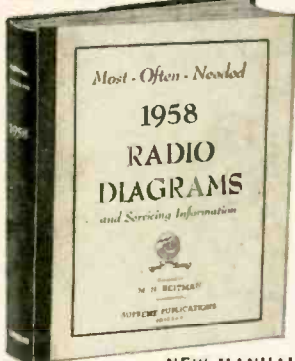

NEW MANUAL

Be prepared to repair quickly all new 1958 radio sets. In this big volume you have easy-to-use, large schematics, needed alignment data, replacement parts lists, voltage values, and information on stage gain, location of trimmers, and dial stringing, for almost every 1958 radio. Includes auto radios, transistor portables, and all types and makes of home sets. Giant in size, $8\frac{1}{2} \times 11\frac{1}{2}$ " manual style, sturdy binding. Price, only **\$2.50**



TELEVISION SERVICING COURSE
Let this new course help you in TV servicing. Amazing bargain, complete only \$3, full price for all lessons. Giant in size, mammoth in scope, topics just like a \$200.00 correspondence course. Lessons on picture faults, circuits, adjustments, short-cuts, UHF, hints, alignment facts, antenna problems, troubleshooting, how to use test equipment, fault-finding hints, picture analysis. Special, only... **\$3**

Supreme Publications
Sold by All Leading Parts Jobbers



Electronics Manufacturing Co., 100 W. Green St., Rockford, Ill.
POWER-SAW KIT, model 505K. Includes "8 saws in 1" in kit form. Metal carrying case,

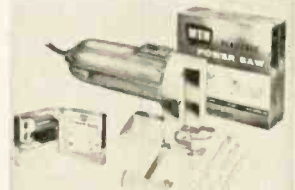

circle cutter, ripsaw attachment, 5 assorted blades. 1.8-amp motor developing 2,650 strokes per minute under load.—**Wen Products Inc.**, 5806 Northwest Highway, Chicago 31, Ill.

TV SWITCH RECEPTACLE, Switchmatic. Wall receptacles installed in desired locations in home. Antenna lead is connected to one and balance of receptacles connected to one another. Antenna input automatically



switched to receptacle in which TV set is plugged; unused lead wires are switched out. Two circuits can be operated from single antenna by adding *Humi-Kup* Switchmatic Interlock Coupler at antenna mast.—**R-Columbia Products Co. Inc.**, Highwood, Ill.

TV ANTENNA, Clear-View CV-1 (1-bay) and CV-2 (2-bay).

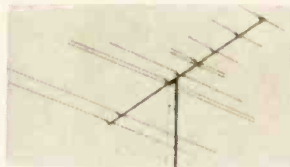

Designed for vhf fringe areas. Compact high-gain unit. All elements snap into position. Aluminum and aluminized riveted construction.—**Kay-Townes Antenna Co.**, Box 593, Rome, Ga.

ANTENNA BUMPER MOUNT, model ASP-143S. For professional emergency communication



services. Stainless steel mount has 2 double-strength chains of flat-Z links. Attached with open-end wrench, conforms to shape of bumper. Single-chain mount in stainless steel, *model M-2AS*; in cadmium-plated steel, *M-2A*.

Double-chain in cadmium plate, *ASP-143—Antenna Specialists Co.*, 12435 Euclid Ave., Cleveland.

FM ANTENNAS, Model FM-2K in-line type (shown); *FM-1K*, turnstile type; *FM-6*, 6-element broadband Yagi for equal high gain over entire FM

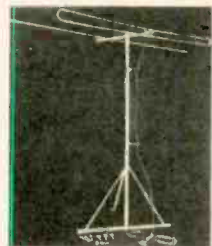

band. *FM-1K* and *FM-2K* with complete installation kit.—**Trio Mfg. Co.**, Griggsville, Ill.

TAB MOUNT CONTROLS, series B47. Replacement line in-



cludes 25 resistance values meeting most electrical requirements. Each has 1-inch knurled and slotted phenolic shaft.—**Clarostat Manufacturing Co. Inc.**, Dover, N. H. **END**

All specifications on these pages are from manufacturers' data.

New SUPREME 1958 Radio Manual

Now you can benefit and save money with Supreme amazing scoop of 1958. This one giant volume has all the service data you need on all recent radio sets. A full year of models of all popular makes, home and auto sets, portable radios, combinations, changers, all included. The full price for this mammoth 1958 manual is only \$2.50, nothing else to buy for a whole year. Other Supreme radio service volumes for previous years (mostly at \$2) are described below. Separate TV manuals are listed at right.

SUPREME RADIO MANUALS FOR PREVIOUS YEARS

Use Supreme manuals to repair all radios faster, easier; save time and make more money. Here is your lowest-priced service data. Covers all years, from 1926-38 to 1958 models, in 18 volumes. Used by 174,000 shrewd servicemen. Most volumes only \$2 each, see coupon. Average volume 190 large pages, $8\frac{1}{2} \times 11$ inches. Quality printing, easy to use, manual-style binding. Amazing values. Be wise, use these manuals to get all needed diagrams, parts lists, alignment facts, and service hints, at the smallest cost. See your jobber or send no-risk trial coupon. →

SUPREME TELEVISION SERIES

Here is your complete source of TV service data at lowest prices. Supreme manuals at only \$3 each are amazing bargains and defy competition. Each annual manual covers a whole year of models, using original factory material. Include giant double-spread circuits and blueprints, alignment procedure, waveforms, voltage charts, factory revisions, and helpful service hints. Select volumes from list below and send no-risk coupon.

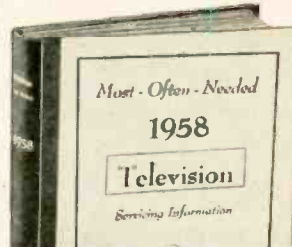

- 1958 TV Manual, \$3
- 1957 Early TV, \$3
- 1957 Late TV, \$3
- 1956 TV Manual, \$3
- 1955 Early TV, \$3
- 1955 Late TV, \$3
- 1954 TV Manual, \$3
- 1953 TV Manual, \$3
- 1952 TV Manual, \$3
- 1951 TV Manual, \$3
- 1950 TV Manual, \$3
- 1949 TV Manual, \$3
- 1948 TV Manual, \$3

NO-RISK TRIAL ORDER COUPON

SUPREME PUBLICATIONS, 1760 Balsam Rd., Highland Park, Ill.

<input type="checkbox"/> 1958 Radio Diagrams, \$2.50 <input type="checkbox"/> 1957 Radio Manual, \$2.50 <input type="checkbox"/> 1956 Radio Diagrams, \$2.50 <input type="checkbox"/> 1955 Radio Manual, only \$2 <input type="checkbox"/> 1954 These annual RADIO volumes specially priced at only \$2.50 each. <input type="checkbox"/> 1951 <input type="checkbox"/> 1950 <input type="checkbox"/> 1949 <input type="checkbox"/> 1948 <input type="checkbox"/> 1947 <input type="checkbox"/> 1946 <input type="checkbox"/> 1942 <input type="checkbox"/> 1941 <input type="checkbox"/> 1940 <input type="checkbox"/> 1939 <input type="checkbox"/> 1926-1938 Manual, \$2.50 <input type="checkbox"/> Radio & TV Master Index, 25¢	Rush today TV manuals checked <input checked="" type="checkbox"/> below and Radio manuals at left. Satisfaction guaranteed. <input type="checkbox"/> New 1958 Television Servicing Manual, only... \$3. <input type="checkbox"/> Additional 1957 TV, \$3. <input type="checkbox"/> Early 1957 TV, \$3. <input type="checkbox"/> 1956 Television Manual, \$3. <input type="checkbox"/> Early 1955 TV, \$3. <input type="checkbox"/> Additional 1955 TV, \$3. <input type="checkbox"/> 1954 TV Manual, \$3. <input type="checkbox"/> 1953 Television Manual, \$3. <input type="checkbox"/> 1952 TV, \$3. <input type="checkbox"/> 1951 Television Manual, \$3. <input type="checkbox"/> 1950 TV, \$3. <input type="checkbox"/> 1949 TV Manual, \$3. <input type="checkbox"/> 1948 TV Manual, \$3. <input type="checkbox"/> New Television Servicing Course, complete... \$3. <input type="checkbox"/> I am enclosing \$..... Send postpaid. <input type="checkbox"/> Send C.O.D. I am enclosing \$..... deposit. Name: Address:
---	---

\$500,000 End-of-Summer MARKDOWN SALE!

Lektron's Fabulous Give-Away Event Offers You

DOUBLE-BARREL VALUES!

WRITE TODAY FOR FREE
12-PAGE FLYER OF
MARKDOWN VALUES!

FREE!
BUY TEN
POLY-PAKS
PICK 11TH
FREE!

FREE!
WITH EVERY
ORDER OF \$6
OR MORE,
SURPRISE
GIFT!

UNTIL OCTOBER 1 ONLY!

OUR USUAL \$1.00
POLY-PAKS[®]
MARKED DOWN
TO ONLY **88¢**

- 2 MIKE TRANSFORMERS.** carbon. Imp. 100 to 100K ohms. Leads enclosed. Wt. 2 lbs. **88¢**
- 6 SYLVANIA SILICON DIODES.** 1N22, 1N29. Reg. \$36. **88¢**
- \$25 SURPRISE PACK!** Large asst. Radio & TV parts. Wt. 3 lbs. **88¢**
- 20 CAMEL HAIR BRUSHES.** 100% pure bristle. Sizes 1-6. **88¢**
- 40 PRINTED CIRCUIT PARTS.** Diodes, chokes, resistors, cond., boards. Wt. 1 lb. **88¢**
- 3 AC-DC CHOKES,** for power supplies. 50 to 200 ma. Open frame. Wt. 3 lbs. Reg. \$9. **88¢**
- 40 SUB-MINI CONDENSERS** for transistor, printed circuit work. Wt. 1 lb. Reg. \$7. **88¢**
- 10 RADIO-TV ELECTROLYTICS.** 10-500 mf. to 450 VDC. Reg. \$12. Wt. 3 lbs. **88¢**
- 60 SUB-MINI RESISTORS.** 1/4" long. 70 values. 1/5 W. to 10 meg. Reg. \$6. **88¢**
- TEN 3-SECOND TIMER mechanisms.** Precision geared. Wt. 2 lbs. Reg. \$30. **88¢**
- 5 HORSESHOE MAGNETS.** Powerful. Dozens of uses! **88¢**
- 60 MICA CONDENSERS.** .0025 to .01 to 1200V. Silver. Tool \$25. **88¢**
- 4-IN-1 DRILL BIT.** Cupes, saws, drills, reams all shape holes. **88¢**
- 80 HALF-WATTERS.** Asst'd. value carbon resistors. Incl. 5%. Reg. \$12. **88¢**
- 60 ONE-WATTERS.** Asst'd. value carbon resistors. 5%, 10%. **88¢**
- 4 TRANSISTOR OSC. COILS** for printed circuit & transistor portable radios. Reg. \$5. **88¢**
- 50 KNOBS,** radio & TV. Some worth \$1 ea. Asst'd. colors, insulation. Wt. 2 lbs. **88¢**
- 100 CERAMIC CONDENSERS,** Hi-Q. discs. tubular. to .01 mf. Wt. 2 lbs. Reg. \$11. **99¢**
- 0-9999 COUNTER,** Vee-der-Root, w/double shafts. Reg. \$5. **88¢**
- 60-PC. CONDENSER SPECIAL**—molded, paper, ceramic, oil, mica, discs, variable. Wt. 2 lbs. **88¢**
- 65-PC. RESISTOR SPECIAL**—WW, precision, carbon, variable, mini. Worth \$15. Wt. 3 lbs. **88¢**
- 15-PC. TWIST DRILL KIT,** 1/16" thru 3/4" by 64ths. w/calibrated case. Reg. \$3. **88¢**
- 60 TUBULAR CONDENSERS,** paper, molded, oil, etc. .002 to 5mf to 1,000V. Wt. 2 lbs. Reg. \$12. **88¢**
- 8 PILOT LITES** with assorted jewels; 75c Ea. **88¢**
- MINI-METER,** 1 1/4" dia. 0-6 Amps A.C. Wt. 1 lb. Reg. \$3. **88¢**

- 12 POLY BOXES.** Clear plastic, hinged, w/snap locks. Asst'd. sizes. Wt. 1 lb. **88¢**
- 4 OUTPUT TRANSFORMERS.** 50L6, etc. Wt. 3 lbs. **88¢**
- 30 DISC CONDENSERS.** Wafer-thin. To .01 mf. Reg. \$5. **88¢**
- "SUN" BATTERY,** sim-ilar to famed B3M. 1" long. Reg. \$2.50. **88¢**
- 35 PRECISION RESISTORS** 1%, 1/2 & 1 W. Carboloy & WW. 100 ohms to 1 meg. Reg. \$17. **98¢**
- 15 ROTARY SWITCHES,** asst'd. gangs. Wt. 3 lbs. Reg. \$12. **88¢**
- 60 HI-Q CARBON RESISTORS,** IRC. Ohmite. 1%, tool L2, 1 W. 10 ohms to 10 meg. Wt. 2 lbs. Reg. \$13. **88¢**
- 60 COILS, CHOKES, IF, RF, Ant. Slug-tuned,** too. Wt. 3 lbs. **88¢**
- 300-FT. HOOKUP WIRE,** Tinned, asst'd. colors, sizes. Wt. 2 lbs. Reg. \$5. **88¢**
- 15 VOLUME CONTROLS,** Incl. duals. To 1 meg; some w/switch. Wt. 2 lbs. Reg. \$12. **88¢**
- 1500 PCS. HARDWARE** Nuts, screws, washers, etc. Wt. 2 lbs. **88¢**
- 60 PLUGS, RECEPTACLES.** Audio, power, spkr. etc. Wt. 2 lbs. **88¢**
- 40 HI-Q CONDENSERS.** Finest porcelain. NPO's too! Wt. 1 lb. **88¢**

- 8 GERMANIUM DIODES** w/long leads. **88¢**
- FERRI-LOOPSTICK** Glass sealed. Reg. \$5. **88¢**
- CORES** to 7". **88¢**
- 15 INSTRUMENT KNOBS,** Raytheon, Bakelite, w/brass insert & set screws. Skirted incl. Wt. 2 lbs. Reg. \$12. **88¢**
- 35 TUBE SOCKETS,** 4 to 9-pin; ceramic, mica, shield-based, too. Wt. 2 lbs. Reg. \$9. **88¢**
- 20 PRINTED CIRCUITS.** Built-in R/C circuits, incl. integrals. Wt. 1 lb. Reg. \$7. **88¢**
- 125 CARBON RESISTORS,** 1/2 to 2 W; 15 ohms to 1 meg. Insulated types incl. **88¢**
- SYLVANIA TV MIRROR.** 10x12" stainless steel. Many uses! Wt. 2 lbs. Reg. \$4. **88¢**
- 10 PANEL SWITCHES.** 115 VAC; SPST. SPDT, etc. Wt. 1 lb. **88¢**
- POSTAGE-STAMP MIKE.** Crystal, 100 to 8,000 cps. Wt. 1 lb. **88¢**
- 50 TERMINAL STRIPS,** Solder-lug & binding; to 20 terms. Wt. 2 lbs. **88¢**
- 6 TRANSISTOR SOCKETS** ETS. Molded; for sub-mini tubes; 88¢ too.
- 30 MOLDED CONDENSERS.** Black beauties, etc. Finest made! Wt. 2 lbs. **88¢**
- 30 POWER RESISTORS.** WW. 5 to 50 W; to 10,000 ohms. Vitreous too. Wt. 3 lbs. **88¢**

New Tubes & Semi-conductors

THIS month's releases range from high-frequency alloy-junction transistors to diffused silicon rectifiers, and include two tubes, one for TV sets and the other for auto radios.

2N417
A p-n-p alloy-junction transistor designed and tested for high-frequency amplifier applications up to 15 mc. Maximum ratings of the Tung-Sol 2N417 are:

VCB	30
VEB	20
VCE	10
IC (ma)	200
IC (peak ma)	400

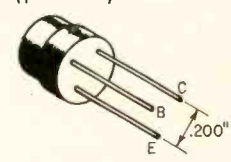

- 2N417
- 2N438
- 2N439
- 2N440

2N438, 2N439, 2N440
A group of n-p-n alloy-junction germanium transistors capable of very fast response under transient pulse operation. Their design is ideal for switching, flip-flop and if amplifier circuits. Each type has a different range of high-frequency alpha cutoff. In the 2N438 alpha-cutoff point ranges between 2.5 and 5 mc; in the 2N439 between 5 and 10 mc and in the 2N440 beyond 10 mc. Maximum ratings of these CBS-Hytron units are:

PCB	30
VEB	25
Vtotal (mw) (derate 2 mw per °C increase in ambient temp)	100

6DA4, 12D4, 17D4
These indirectly heated half-wave rectifiers are intended for use as damping diodes in direct-drive sweep cir-

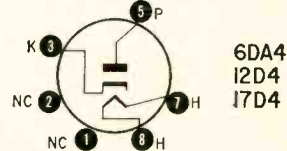

cuits for television receivers. Outside of their heater ratings, all three tubes are identical. The 6DA4 has a 6.3-volt 1.2-amp, the 12D4 a 12.6-volt 600-ma and the 17D4 a 16.8-volt 450-ma heater. The 12- and 17-volt versions are intended for series-string use and feature controlled warmup.

Do not confuse the 12D4 and 17D4 with the gas triode 6D4. They are not 12- and 17-volt versions of that tube. Pins 1, 2, 4 and 6 should not be used as tie points.

MORE OF LEKTRON'S FAMOUS

DOLLAR BUYS!

- WORLD'S SMALLEST RADIO.** 2x1x1". Kit incl. loopstick, jacks, diode, etc. w/instructions. Reg. \$3. **\$1**
- 0-60 MINUTE TIMER.** Includes dial & knob. Sound alarm. Wt. 2 lbs. Reg. \$5. **\$1**
- 2 "MICRO" VARIABLES.** 10 to 365 mf. 1 1/2" sq. w/shaft. **\$1**
- 10,000 ohm SENSITIVE RELAY.** Sigma. 1" sq. SPST. w/ neon bulb, etc. Wt. 2 lbs. **\$1**
- 8-PC. NUTDRIVER SET.** \$3 value. Plastic handle. 3/16, 7/32, 1/4, 5/16, 11/32, 3/8, 7/16" steel socket wrenches in plastic case. Wt. 1 lb. **\$1**
- 3 VARI-LOOPSTICKS.** Adj. 510-1500 Kcs. Transistor radios, etc. Wt. 1 lb. **\$1**
- 2 PNP TRANSISTORS.** Pop. make, for hundreds of projects. **\$1**
- 2 TRANSISTOR IF's.** Double tuned. Only 1/2" square. **\$1**
- 2 115 VAC MOTORS.** 1700 RPM. Reg. \$1. **\$1**

HI-FI 12" SPEAKER
 Well-known U.S. maker. 40-12,000 cycles. 3-4 ohm v.c. Heavy PM Ohnico magnet. **\$3.99**

POCKET MULTI-TESTER
 3 1/2 x 2 1/4" bakelite case. 100 ohms/volt. Zero adj. 0/15/150/1000 AC-DC V. 0-150 ma; 0-100-000 ohms. W/test leads & battery. In orig. pack. **\$6.99**

NEW! AIR-POWERED TRANSISTOR RADIO KIT
 As described in "Transistor Topics" (July Popular Electronics). Developed by Telepower. Pocket size. Literally takes "power out of the air" from radiated energy of local radio & TV stations. NO BATTERIES NEEDED! Includes all parts, instructions. **\$6.50**

3-TUBE AC-DC AMP.
 Reg. \$5. Fully wired. ready for use. Sep. vol. tone controls. Lowest price ever! **\$2.99**
TUBES \$1.91 EXTRA

HOW TO ORDER Check items wanted. Return entire ad w/check or M.O. including sufficient postage; excess returned. C.O.D. orders. 25% down; rated, net 30 days. Print name, address WITH POSTAL ZONE NO., amount money enclosed, in margin. (Canada postage, 48c 1st lb., 28c ea. addl. lb.) EXPORT ORDERS INVITED.

LEKTRON

131 Everett Ave.
CHELSEA 50, MASS.

Castle Television Tuner Service

FOR THE EXACT TV TUNER REPLACEMENT
USE A CASTLE REBUILT UNIT
EVERY REBUILT TUNER CARRIES FULL 90 DAYS WARRANTY

Aligned to Original Standards Under Laboratory Conditions

SAME DAY SERVICE
Exchange Tuner shipped same day defective unit received

\$9.95 Dealer Net EACH TUNER
Including All Worn Parts (except tubes, where needed)
Combination UHF/VHF units, \$19.90

Just forward defective Tuner prepaid. Complete with good tubes and all damaged parts; quote make and model.

1723 W. LUNT AVE., CHICAGO 26, ILL. U.S.A.
152 MAIN ST., TORONTO 13, ONT., CANADA

Ambassador 2-7505 OXford 4-5637

Suppliers of rebuilt TV Tuners to leading manufacturers, technicians & service dealers, coast to coast.

Superior's New
Streamlined Model **TD-55**

TUBE TESTER



FOR

The Experimenter or Part-time Serviceman, who has delayed purchasing a higher priced Tube Tester.

The Professional Serviceman, who needs an extra Tube Tester for outside calls.

The Busy TV Service Organization, which needs extra Tube Testers for its field men.

Speedy, yet efficient operation is accomplished by: 1. Simplification of all switching and controls. 2. Elimination of old style sockets used for testing obsolete tubes (26, 27, 57, 59, etc.) and providing sockets and circuits for efficiently testing the new Noval and Sub-Minar types.

CHECKS FOR SHORTS AND LEAKAGES BETWEEN ALL ELEMENTS—Model TD-55 provides a super sensitive method of checking for shorts and leakages up to 5 Megohms between any and all of the terminals. Continuity between various sections is individually indicated. **"FREE-POINT" ELEMENT SWITCHING SYSTEM**—Model TD-55 incorporates a newly designed element selector switch system which reduces the possibility of obsolescence to an absolute minimum. Any pin may be used as a filament pin and the voltage applied between that pin and any other pin, or even the "top-cap." **ELEMENTAL SWITCHES ARE NUMBERED IN STRICT ACCORDANCE WITH R.M.A. SPECIFICATION**—The 4 position fast-action snap switches are all numbered in exact accordance with the standard R.M.A. numbering system. Thus, if the element terminating in pin No. 7 of a tube is under test, button No. 7 is used for that test.

Model TD-55 comes complete with operating instructions and charts. Housed in rugged steel cabinet. Use it on the bench—use it for field calls. A streamlined carrying case, included at no extra charge, accommodates the tester and book of instructions.

\$26⁹⁵

Superior's New
Model **TW-11**

STANDARD PROFESSIONAL TUBE TESTER



- Tests all tubes, including 4, 5, 6, 7, Octal, Lock-In, Hearing Aid, Thyatron, Miniatures, Sub-miniatures, Novals, Sub-minars, Proximity fuse types, etc. • Uses the new self-cleaning Lever Action Switches for individual element testing. Because all elements are numbered according to pin-number in the RMA base numbering system, the user can instantly identify which element is under test. Tubes having tapped filaments and tubes with filaments terminating in more than one pin are truly tested with the Model TW-11 as any of the pins may be placed in the neutral position when necessary. • The Model TW-11 does not use any combination type sockets. Instead individual sockets are used for each type of tube. Thus it is impossible to damage a tube by inserting it in the wrong socket.

- Free-moving built-in roll chart provides complete data for all tubes. All tube listings printed in large easy-to-read type.

- **NOISE TEST:** Phono-jack on front panel for plugging in either phones or external amplifier will detect microphonic tubes or noise due to faulty elements and loose internal connections.

EXTRAORDINARY FEATURE

- **SEPARATE SCALE FOR LOW-CURRENT TUBES**—Previously, on standard emission type tube testers, it has been standard practice to use one scale for all tubes. As a result, the calibration for low-current types has been restricted to a small portion of the standard scale. The extra scale used here greatly simplifies testing of low-current types.

The Model TW-11 operates on 105-130 Volt 60 Cycles A.C. Comes housed in a beautiful hand-rubbed oak cabinet complete with portable cover.

\$47⁵⁰

Superior's New
Model **82**

RAPID TESTER

The Very Best Value in
Multi-Socket Tube Testers!



Production of this Model was delayed a full year pending careful study by Superior's engineering staff of this new method of testing tubes. We don't expect it to replace conventional testers but if you want to try this new type of tester, you can do no better than mail the coupon below. Don't let the low price mislead you! We claim Model 82 will outperform similar looking units which sell for much more—and as proof, we offer to ship it on our examine before you buy policy.

Primarily, the difference between the conventional tube tester and the multi-socket type is that in the latter, the use of an added number of specific sockets (for example, in Model 82 the noval is duplicated eight times) permits elimination of element switches thus reducing testing time and possibility of incorrect switch readings.

To test any tube, you simply insert it into a numbered socket as designated, turn the filament switch and press down the quality switch—THAT'S ALL! Read quality on meter. Inter-element leakage, if any indicates automatically.

FEATURES:

- ★ Dual Scale meter permits testing of low current tubes.
- ★ 7 and 9 pin straighteners mounted on panel.
- ★ All sections of multi-element tubes tested simultaneously.
- ★ Use of 22 sockets in improved circuit permits testing over 600 tube types and prevents possible obsolescence.
- ★ Ultra-sensitive leakage test circuit will indicate leakage up to 5 megohms.
- ★ Employs new type 4" air-damped meter resulting in accurate vibrationless readings.

\$36⁵⁰

SHIPPED ON APPROVAL NO MONEY WITH ORDER — NO C.O.D.

We invite you to try before you buy any of the models described on this and the following page. If after a 10 day trial you are completely satisfied and decide to keep the Tester, you need send us only the down payment and agree to pay the balance due at the monthly indicated rate. (See other side for time-payment schedule details.)

**NO INTEREST
OR FINANCE**

CHARGES ADDED!

If not completely satisfied, you are privileged to return the Tester to us, cancelling any further obligation.

SEE OTHER SIDE!

Cut out and mail TODAY! ▶

All prices net, F.O.B., N.Y.C.

FIRST CLASS
Permit No. 61430
New York, N. Y.

BUSINESS REPLY CARD

No Postage Stamp Necessary if Mailed in the U. S.

VIA AIR MAIL

POSTAGE WILL BE PAID BY —

MOSS ELECTRONIC DIST. CO., INC.

3849 TENTH AVENUE

NEW YORK 34, N. Y.

Superior's New
Model 76

ALL-PURPOSE BRIDGE

IT'S A

- ✓ CONDENSER BRIDGE
- ✓ RESISTANCE BRIDGE
- ✓ SIGNAL TRACER
- ✓ TV ANTENNA TESTER



SPECIFICATIONS:

CAPACITY BRIDGE SECTION—4 Ranges: .00001 Microfarad to 1000 Microfarads. Will also locate shorts, and leakages up to 20 megohms. Measures the power factor of all condensers from .1 to 1000 Microfarads. (Power factor is the ability of a condenser to retain a charge and thereby filter efficiently.)

RESISTANCE BRIDGE SECTION—2 Ranges: 100 ohms to 5 megohms. Resistance can be measured without disconnecting capacitor connected across it. (Except, of course, when the R C combination is part of an R C bank.)

SIGNAL TRACER SECTION—With the use of the R.F. and A.F. Probes included with the Model 76, you can make stage gain measurements, locate signal loss in R.F. and Audio stages, localize faulty stages, locate distortion and hum, etc. Provision has been made for use of phones and meter if desired.

TV ANTENNA TESTER SECTION—Loss of sync., snow and instability are only a few of the faults which may be due to a break in the antenna, so why not check the TV antenna first? 2 Ranges: 2' to 200' for 72 ohm coax and 2' to 250' for 300 ohm ribbon.

Model 76 comes complete with all accessories including R.F. and A.F. Probes; Test Leads and operating instructions. Nothing else to buy.

\$26⁹⁵

Superior's New
Model 77

VACUUM TUBE VOLTMETER

WITH NEW 6" FULL-VIEW METER!



AS A DC VOLTMETER—Will measure any voltage up to 1500 volts with negligible loading. Indispensable in receiver and Hi-Fi Amplifier servicing and a must for Black and White and color TV servicing where circuit loading cannot be tolerated.

AS AN AC VOLTMETER—Will quickly and simply measure RMS value if sine wave, and peak-to-peak value if complex wave. Pedestal voltages that determine the "black" level in TV receivers, sync pulses and saw tooth voltages are easily read.

AS AN ELECTRONIC OHMMETER—Because of its wide coverage of measurement in the resistance range (from .2 ohms to 1,000 megohms) the Model 77 will be your most frequently used resistance meter. Leaky capacitors show up glaringly when tested with the Model 77.

SPECIFICATIONS

DC VOLTS—0 to 3/15/75/150/300/750/1500 volts at 11 megohms input resistance.

AC VOLTS (RMS) — 0 to 1.5/7.5/150/300/750/1500 volts.

AC VOLTS (Peak to Peak)—0 to 8/40/200/400/800/2000 volts.

ELECTRONIC OHMMETER — 0 to 1000 ohms/10,000 ohms/100,000 ohms/1 megohm/10 megohms/100 megohms/1,000 megohms.

DECIBELS— -10 db to +18 db, +10 db to +38 db, +30 db to +58 db. All based on 0 db=.006 watts (6 mw) into a 500 ohm line (1.73v).

ZERO CENTER METER—For discriminator alignment with full scale range of 0 to 1.5/7.5/37.5/75/150/375/750 volts at 11 megohms input resistance.

Model 77 comes complete with operating instructions, probe, test leads and carrying case. Operates on 110-120 volt 60 cycle. Only

\$42⁵⁰

Superior's New
Model 79

SUPER- METER

WITH NEW 6" FULL-VIEW METER!



A Combination VOLT-OHM MILLIAMMETER
• Plus CAPACITY, REACTANCE, INDUCTANCE AND DECIBEL MEASUREMENTS • Also Tests SELENIUM AND SILICON RECTIFIERS, SILICON AND GERMANIUM DIODES.

SPECIFICATIONS

- D.C. VOLTS—0 to 7.5/15/75/150/750/1,500.
- A.C. VOLTS—0 to 15/30/150/300/1,500/3,000.
- D.C. CURRENT—0 to 1.5/15/150 Ma. 0 to 1.5/15 Amperes.

- RESISTANCE—0 to 1,000/100,000 Ohms. 0 to 10 Megohms.
- CAPACITY—.001 to 1 Mfd. 1 to 50 Mfd.
- REACTANCE—50 to 2,500 Ohms, 2,500 Ohms to 2.5 Megohms.
- INDUCTANCE—.15 to 7 Henries, 7 to 7,000 Henries.
- DECIBELS—-6 to +18, +14 to +38, +34 to +58.

The following components are all tested for QUALITY at appropriate test potentials. Two separate BAD-GOOD scales on the meter are used for direct readings.

- All Electrolytic Condensers from 1 MFD to 1000 MFD.
- All Selenium Rectifiers.
- All Germanium Diodes.
- All Silicon Rectifiers.
- All Silicon Diodes.

Model 79 comes complete with operating instructions and test leads. Use it on the bench—use it on calls. A streamlined carrying case included at no extra charge accommodates the tester, instruction book and test leads.

\$38⁵⁰

SHIPPED ON APPROVAL NO MONEY WITH ORDER — NO C.O.D.

MOSS ELECTRONIC DISTRIBUTING CO., INC.
Dept. D-493, 3849 Tenth Ave., New York 34, N. Y.

Please send me the units checked. I agree to pay down payment within 10 days and to pay the monthly balance as shown. It is understood there will be no finance or interest charges added. It is further understood that should I fail to make payment when due, the full unpaid balance shall become immediately due and payable.

- Model TD-55 ... Total Price \$26.95
\$6.95 within 10 days. Balance \$5.00
monthly for 4 months.
- Model TW-11 ... Total Price \$47.50
\$11.50 within 10 days. Balance
\$6.00 monthly for 6 months.
- Model 82 ... Total Price \$36.50
\$6.50 within 10 days. Balance \$6.00
monthly for 5 months.

- Model 76 ... Total Price \$26.95
\$6.95 within 10 days. Balance \$5.00
monthly for 4 months.
- Model 77 ... Total Price \$42.50
\$12.50 within 10 days. Balance
\$6.00 monthly for 5 months.
- Model 79 ... Total Price \$38.50
\$8.50 within 10 days. Balance \$6.00
monthly for 5 months.

Name _____
Address _____
City _____ State _____

All prices net, F.O.B., N.Y.C.

We invite you to try before you buy any of the models described on this and the preceding page. If after a 10 day trial you are completely satisfied and decide to keep the Tester, you need send us only the down payment and agree to pay the balance due at the monthly indicated rate.

NO INTEREST OR FINANCE CHARGES ADDED!

If not completely satisfied, you are privileged to return the Tester to us, cancelling any further obligation.

SEE OTHER SIDE!

◀ Cut out and mail TODAY!

Maximum ratings of these Sylvania tubes in damper service are:

VP (piv)	4,400
Pp (watts)	5.5
I (peak steady state) (ma)	900
IP (ma)	155

Abbreviations

A number of abbreviations used in reference to transistor characteristics are often confusing. To end any doubt as to what a particular symbol stands for this list has been assembled.

- I_c, I_e, I_b—Dc currents to collector, emitter or base.
- V_{CB}—Voltage, collector to base.
- V_{EB}—Voltage, emitter to base.
- V_{CE}—Voltage, collector to emitter.
- V_{BE}—Voltage, base to emitter.
- BV_{CEO}—Breakdown voltage, collector-to-base junction reverse-biased, emitter open-circuited (value of I_c should be specified).
- V_{CE0}—Voltage, collector to emitter, at zero base current with the collector junction reverse-biased. Specify I_c.
- BV_{CE0}—Breakdown voltage, collector to emitter, with base open-circuited.
- V_{CCB}—Supply voltage, collector to base.
- V_{CCE}—Supply voltage, collector to emitter.
- V_{EBE}—Supply voltage, base to emitter.
- I_{CO}—Collector current when collector junction is reverse-biased and emitter is dc open-circuited.
- I_{EO}—Emitter current when emitter junction is reverse-biased and collector is dc open-circuited.
- I_{CE0}—Collector current with collector junction reverse-biased and base open-circuited.
- NF—Noise figure.
- G_e—Common-emitter power gain.
- G_b—Common-base power gain.
- P_c—Collector power dissipation.
- h_{ib}—Common-base input impedance, output ac short-circuited.

2N464, 2N465, 2N466, 2N467

Germanium p-n-p alloy-junction transistors designed for general purpose use in the audio-frequency range.

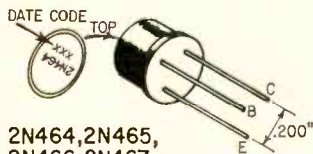

2N464, 2N465, 2N466, 2N467

Maximum ratings of these Motorola units are:

	2N464	-465	-466	-467
V _{CB}	45	45	35	35
V _{CE}	40	30	20	15
V _{EB}	12	12	12	12
I _C (ma)	100	100	100	100
P _c (mw) (derate 2.5 mw per °C above 25 °C)	150	150	150	150

12EG6

A 7-pin miniature type pentagrid amplifier intended for use as an rf amplifier in hybrid auto receivers where tube and transistor voltages are ob-

**NO SPEAKER
INSTALLATION
PROBLEMS**
with
QUAM
Adjust-a-Cone
SPEAKERS

QUAM speakers have transformer mounting brackets welded to the baskets.

There is a universal mounting bracket packed with every QUAM 3½", 4", 5", 5¼", 6½", 4" x 6" and 5" x 7" Adjust-a-Cone speaker, AT NO EXTRA COST. In addition there are four threaded mounting holes in the pot . . . besides the usual mounting holes in the speaker basket.

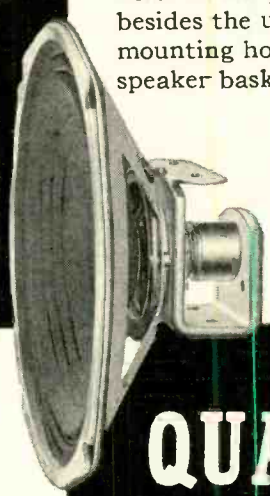

A good hi-fi speaker need not be expensive. Prove it to yourself by listening to QUAM extended range and coaxial speakers. They can't be beat for small budget hi-fi installations. Write for QUAM Hi-Fi Catalog No. 69.

QUAM
HI-FI
SPEAKERS
for fine audio reproduction at low cost

ask for QUAM, the quality line, for all your speaker needs
QUAM-NICHOLS COMPANY
236 EAST MARQUETTE ROAD • CHICAGO 37, ILLINOIS

SUPER POWERED SINGLE CHANNEL AMPLIFIER
Minimum 20 V—5 Watts on All Channels

This all new super powered unit has the highest output of any TV channel amplifier with sufficient power to cover large communities with ample signal voltage and deliver a strong signal thru many miles of cable. The unit was designed specifically for community television and is the only unit of its kind that does not produce power in fractions of a watt. For full rated output a high-powered commercial transmitting tube is used.

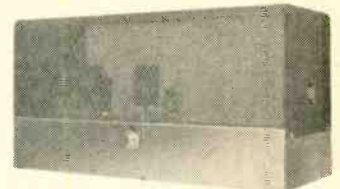

- C. C. S. Service
- 26 db min. gain
- 6-8 mcs. band width
- Channels 2-13 as specified
- Requires only 1 V input
- Co-axial input and output connectors for 75 OHM Line
- Linear class A operation
- Low Power Drain (1 Amp.)

MODEL SPA
\$350

Write for details today

SEG Electronics • 1778 Flatbush Ave., Brooklyn 10, New York



STOP!
Demand the finest in Electronic Test Equipment—EMC, of course. You get the most quality per measurement dollar!

NEW! EMC Model 301 Speedi Tube Tester

Checks tubes in seconds. Checks shorts, leakages, and quality. Over 375 tubes, including 0Z4, now listed. New listings available. Uses line voltage regulation. Checks and rejuvenates Picture Tubes with Model PTA (Picture Tube Adaptor), at only \$4.50. Model 301P (illustrated),

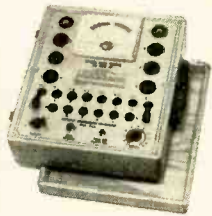

with 4 1/2" meter & oak Carrying case \$47.50
Kit 33.20
Model 302C, (with 7 1/2" meter) 62.90
Kit 47.90



NEW! EMC Model 108 Handi Tester

The only appliance and auto battery tester in its price class to use a D'Arsonval, instead of an iron vane type meter. Gives exclusive advantages of maximum accuracy and scale length, and minimum battery replacement cost... at no added charge. Complete with test leads and instruction manual.

Wired \$15.95 Kit 12.95

NEW! EMC Model 905-6A Battery Eliminator, Charger, and Vibrator Checker

A MUST for auto radio service. Features continuously variable voltage output—in either 6 or 12 volt operation. Checks all 6 or 12 volt vibrators.



Wired \$67.90 Kit 44.90

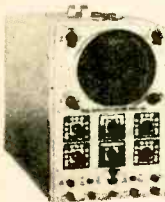

NEW! EMC Model 601, Wide Band Oscilloscope for Color & Monochrome TV

Features full 5 mc band with push-pull vertical amplifier with sensitivity .02 volts per inch, retrace blanking amplifier for clearer pictures, and multivibrator sweep from 15 cycles to over 75 kilocycles. Wired and tested ...\$119.90

NEW! EMC Model 206P Dynamic Mutual Conductance Tube Tester

The lowest priced mutual conductance tube checker on market. Checks tubes for microhm value and gas content. Completely flexible switching. Your best buy in a quality tube tester. (Hand rubbed Carrying Case) ...\$83.50



NEW TUBES & SEMICONDUCTORS (Cont'd)

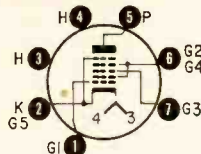

I2E66

tained from a 12-volt storage battery.

The design of this RCA tube permits using grids 1 and 3 as independent control electrodes. This provides for improved avc under large-signal conditions when both grids are biased by the avc voltage.

Maximum ratings in class-A1 amplifier use are:

Vp	16
Vg2, Vg4	16
Vg3 (pos value)	0
(neg value)	-16
Ik (ma)	20
VH-K	16
Rg3 (megohms)	10

2N548

A medium-power n-p-n silicon transistor designed for switching and amplifying applications in output stages, servo-motor control, magnetic

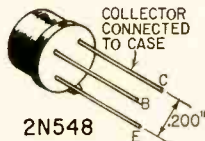

2N548

core switching, solenoid operation, dc-to-dc converters and medium-power oscillators. The collector is connected to the transistor's case.

Maximum ratings of the Transistron 2N548 are:

VCE	30
VCB	30
VEB	10
Ptotal	
(100°C case temp) (watts)	5
(200°C case temp) (mw)	500
(100°C amb temp) (mw)	600
(200°C amb temp) (mw)	50

1N1124, 1125, 1126, 1127, 1128

A group of diffused silicon rectifiers designed for all medium-power applications. Available with anode or cathode connected to stud. All units handle 3 amperes average rectified forward cur-

ANODE TO STUD

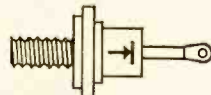

1N1124R TO 1N1128R

CATHODE TO STUD

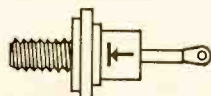

1N1124 TO 1N1128

rent at 50°C and recurrent peaks of 10 amps. Peak inverse voltage ratings of these Texas Instruments rectifiers are: 1N1124, 200; 1N1125, 300; 1N1126, 400; 1N1127, 500 and 1N1128, 600 volts. Units with the anode connected to the stud are indicated by an R suffix after the type number.

"ONE DOLLAR" buys

As much as \$15 worth—Everything Brand New and sold to you with a money back guarantee.

DEDUCT 10% ON ANY ORDER OF \$10 OR OVER
Plus a **FREE SURPRISE PACKAGE**

- \$15 - "JACKPOT" TELEVISION PARTS.....\$1
- TV FOCUS COILS 247, 330 or 470Ω each.....\$1
- 20 - TUBULAR CONDENSERS .05-600v.....\$1
- 20 - TUBULAR CONDENSERS .25-600v.....\$1
- 20 - TUBULAR CONDENSERS .001-1000v.....\$1
- 3 - ELECTROLYTIC COND. 60/40-450v.....\$1
- 100 - ASSORTED FUSES popular sizes.....\$1
- 100 - ASST. 1/2 WATT RESISTORS some 5%.....\$1
- 70 - ASSORTED 1 WATT RESISTORS.....\$1
- 35 - ASSORTED 2 WATT RESISTORS.....\$1
- 50 - ASST. TUBULAR CONDENSERS.....\$1
- 10 - 6' ELECTRIC LINE CORDS with plugs.....\$1
- 5 - TV CHEATER CORDS with both plugs.....\$1
- 4 - 50' SPOOLS HOOK-UP WIRE 4 colors.....\$1
- 50 - STRIPS ASST. SPAGHETTI best sizes.....\$1
- 100 - ASST. RUBBER GROMMETS best sizes.....\$1
- 100 - TWIN LEAD-IN WIRE 300 heavy duty.....\$1
- 50 - FLAT 4-CONDUCT. WIRE many purposes.....\$1
- 25 - INSULATED SHIELDED WIRE.....\$1
- 1 - \$7 INDOOR TV ANTENNA hi-gain 3 section.....\$1
- 20 - ASST. TV KNOBS, ESCUTCHEONS, Etc.....\$1
- 3 - ASST. TOGGLE SWITCHES spst, dpdt, etc.....\$1
- 6 - ASST. SLIDE SWITCHES spst, dpdt, etc.....\$1
- 4 - BAKELITE KNIFE SWITCHES dpdt.....\$1
- 15 - ASST. ROTARY SWITCHES \$15 worth.....\$1
- 100 - FINEST NYLON DIAL CORD best size.....\$1
- 200 - SELF TAPPING SCREWS 8 x 1/2".....\$1
- 35 - ASST. RADIO KNOBS screw and push-on.....\$1
- 100 - KNOB SPRINGS standard size 3/8" x 1/2".....\$1
- 100 - ASSORTED KNOB SET-SCREWS.....\$1
- 25 - ASSORTED CLOCK RADIO KNOBS.....\$1
- 400 - ASST. H'DWARE screws, nuts, rivets, etc.....\$1
- 50 - ASST. SOCKETS octal, noval and miniature.....\$1
- 20 - ASSORTED TUBE SHIELDS best sizes.....\$1
- 50 - ASST. MICA CONDENSERS some in 5%.....\$1
- 50 - ASST. CERAMIC CONDENSERS.....\$1
- 10 - ASST. VOLUME CONTROLS less switch.....\$1
- 5 - ASST. VOLUME CONTROLS with switch.....\$1
- 100 - VOLUME CONTROL HEX NUTS.....\$1
- 20 - ASST. PILOT LIGHTS popular types.....\$1
- 10 - PILOT LIGHT SKTS. bayonet type, wired.....\$1
- 50 - ASST. TERMINAL STRIPS 1, 2, 3, 4 lug.....\$1
- 10 - ASST. RADIO ELECTRO. CONDENSERS.....\$1
- 15 - ASST. TV ELECTROLYTIC CONDENSERS.....\$1
- 15 - ASST. TV COILS sync. peaking, width, etc.....\$1
- 25 - ASST. MICA TRIMMER CONDENSERS.....\$1
- 50 - TUBULAR CONDENSERS .001-600v.....\$1
- 50 - TUBULAR CONDENSERS .01-400v.....\$1
- 2 - ELECTROLYTIC COND. 40/40-450v.....\$1
- 2 - ELECTROLYTIC COND. 40/10/10-450v.....\$1
- 30 - FP CONDENSER MOUNTING WAFERS.....\$1
- 3 - ELECTROLYTIC COND. 80-450v.....\$1
- 3 - ELECTROLYTIC COND. 50/30-150v.....\$1
- 10 - HV TUBULAR CONDENSERS .006-1600v.....\$1
- 10 - HV TUBULAR CONDENSERS .001-6000v.....\$1
- 10 - HV TUBULAR CONDENSERS .005-6000v.....\$1
- 35 - MICA COND. 20-100 mmf & 15-270 mmf.....\$1
- 35 - MICA COND. 20-470 mmf & 15-680 mmf.....\$1
- 35 - MICA COND. 20-820 mmf & 15-1000 mmf.....\$1
- 35 - CERAMIC COND. 20-5 mmf & 15-10 mmf.....\$1
- 35 - CERAMIC COND. 20-25 mmf & 15-47 mmf.....\$1
- 35 - CERAMIC COND. 20-56 mmf & 15-82 mmf.....\$1
- 35 - CERAMIC COND. 20-100 mmf & 15-150 mmf.....\$1
- 35 - CERAMIC COND. 20-270 mmf & 15-470 mmf.....\$1
- 35 - CERAMIC COND. 20-1000 mmf & 15-1500 mmf.....\$1
- 35 - CERAMIC COND. 20-2000 mmf & 15-2000 mmf.....\$1
- 50 - 100Ω 1/2 WATT RESISTORS 5%.....\$1
- 50 - 470KΩ 1 WATT RESISTORS 10%.....\$1
- 75 - 470K 1/2 WATT RESISTORS 10%.....\$1
- 10 - ASST. WIRE'ND RES. 5, 10, 20 watts.....\$1
- 3 - AUDIO OUTPUT TRANS. 50L6 type.....\$1
- 3 - AUDIO OUTPUT TRANS. 6K6 or 6V6 type.....\$1
- 3 - I.F. COIL TRANSFORMERS 456 kc.....\$1
- 3 - I.F. COIL TRANSFORMERS 10.7 mc FM.....\$1
- 4 - OVAL LOOP ANTENNAS asst' hi-gain types.....\$1
- 3 - LOOPSTICK ANT. new ferrite adjustable.....\$1
- 12 - RADIO OSCILLATOR COILS 456 kc.....\$1
- 3 - 1/2 MEG VOLUME CONTROLS with switch.....\$1
- 5 - 50K VOLUME CONTROLS less switch.....\$1
- 10 - SURE GRIP ALLIGATOR CLIPS.....\$1
- 1 - GOLD GRILLE CLOTH 14"x14" or 12"x18".....\$1
- 1 - 5" PM SPEAKER alnico #5 magnet.....\$1
- 5 - SETS SPEAKER PLUGS wired.....\$1
- 10 - SETS PHONO PLUGS and PIN JACKS.....\$1
- 2 - \$2.50 SAPPHIRE NEEDLES 4000 playing.....\$1
- 5 - DIODE CRYSTALS 2-IN21 2-IN23 1-IN64.....\$1
- 2 - SELENIUM RECTIFIERS 1-65 ma & 1-150 ma.....\$1
- 1 - TV VERT. OUTPUT TRANS. 10 to 1 ratio.....\$1
- 5 - TV CRT. SOCKETS with 18" leads.....\$1
- 5 - HI-VOLT. ANODE LEADS with 18" leads.....\$1
- 1 - TV RATIO DETECTOR TRANS. 4.5 mc.....\$1
- 1 - SET TV KNOBS standard type incl. decals.....\$1
- 1 - LB SPOOL ROSIN CORE SOLDER 40/60.....\$1
- 6 - SPIN TIGHT SOCKET SET 3/16" to 7/16".....\$1
- 3 - TV ALIGNMENT TOOLS 5", 7", 12".....\$1

HANDY WAY TO ORDER—Simply tear out advertisement and pencil mark items wanted (X in square is sufficient); enclose with money order or check. You will receive a new copy of this ad for re-orders.

ON SMALL ORDERS—Include stamps for postage, excess will be refunded. Larger orders shipped express collect.

BROOKS RADIO & TV CORP.
84 Vesey St. Dept. A, New York 7 N.Y.

RADIO-ELECTRONICS

Yes, tell me more, send me—FREE—**RE9**
a detailed catalog of the complete EMC line.

NAME _____
STREET _____
CITY _____ STATE _____

EMC Electronic Measurements Corp.
625 B'way • New York 12, N. Y.
Ex. Dept. 370 B'way, N. Y. 13

radio-electronic Circuits

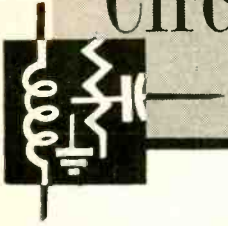

A FEEDBACK BASS CONTROL

Here is a simple bass-boost circuit that will give plenty of vibrant "feelable" bass even with indifferent rigs. And unless you have a rumble-free turntable, it will give you more bass than you can use.

The tube can be any high-mu triode. The 6SF5 works admirably, but you could also use a 6SQ7, 7B6 or (with provision for a screen supply) a pentode like the 6SJ7. I feel that the triodes give better results.

The resistors in the grid circuit can be replaced with a volume control if desired. None of the parts is critical,

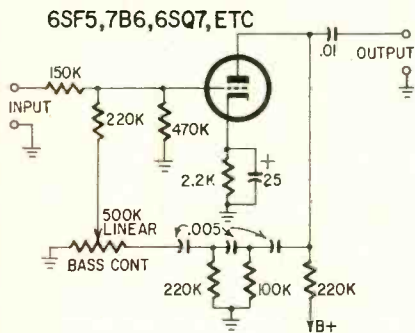

although feedback loop components should stay reasonably close to the values shown.

The one absolute requirement is a well-decoupled power supply, if power is taken from the main amplifier. Not only must this circuit be decoupled, but the other voltage amplifiers must be decoupled from each other or motor-boating is a foregone conclusion. Needless to say, the power supply should also be hum-free.

It is usually preferable to build a separate supply using a small transformer and selenium rectifiers and use the unit as a preamp or between the preamp and main amplifier. In any event, this little unit will perform wonders for an inexpensive audio system.—*R. C. Sandison*

AUTOSWITCH

This simple unit converts an automatic-shutoff changer into a complete automatic-turnoff system. It automatically turns off all components in your hi-fi system at the end of the last record.

The relay is a 117-volt ac type with 3-amp or higher contacts to carry the amplifier load. It is connected across the phono motor on the motor side of the phono switch.

With the circuit shown, here's how



SUITS NEED PRESSING— MERIT DEFLECTION YOKES DO NOT!

Merit deflection yokes are cosine wound TO FORM, not pressed. Pressing can lead to distortion and poor focusing. Pressing after winding frequently causes breakdown.

MERIT COILS AND TRANSFORMERS HAVE "BUILT-IN" ADVANTAGES.

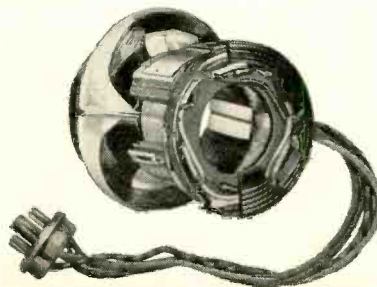

Each Merit yoke is
100% LIVE TESTED



COMPARE IT WITH MERIT

MERIT COIL AND TRANSFORMER CORP.
MERIT PLAZA • HOLLYWOOD, FLORIDA

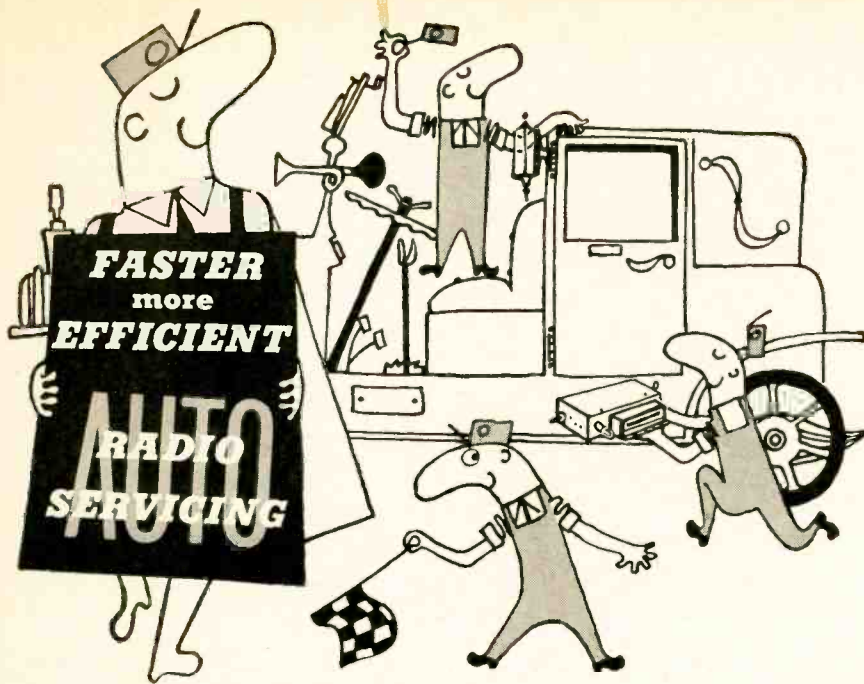

with the **NEW**

STANCOR®

AUTO RADIO

TRANSFORMER

Replacement Guide



FREE! The most complete auto radio guide ever published! This new Stancor service reference lists over 800 models of 39 auto radio manufacturers, including private label brands. They are indexed by manufacturer, model number and year—for quick location of the part you need—from Stancor's extensive line of exact replacement vibrators and audios... including replacements for the new transistor auto radios. Get your copy now from your Stancor distributor or by writing to Chicago Standard.



CHICAGO STANDARD TRANSFORMER CORPORATION

3509 ADDISON STREET · CHICAGO 18, ILLINOIS

Export Sales: Roburn Agencies, Inc., 431 Greenwich Street, New York 13, N. Y.

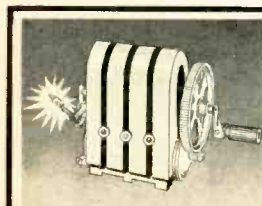

ELECTRIC GENERATOR

Cost over \$20.00 new. Originally used to crank phones. Generates up to 75 volts A.C. Wonderful for experimenting, ring bells, light up neon and other lamps, use as shocker, classroom uses, etc. Each has 3 or 4 five-inch 1 lb. U shape bar magnets (alone worth total cost); generating armature; solid brass gears, and gear crank. Comes ready for use. These are reconditioned magnets, all in good condition. Generator weighs over 8 lbs. Shipping weight—10 lbs. Item No. 130—\$3.95 (P.P. & Hdg. Chgs. \$1.25)

TELEPHONE RINGER BELL

polarized, with strong bar magnet. To be used with Electric Generator. Item No. 130. These work over many miles with generator. Reconditioned. Weight 2 lbs. Item No. 131—\$2.00. (Shpg. chgs. 36c)

Amazing Black Light

250 watt ultra-violet light source. Makes fluorescent objects glow in dark. Fits any lamp socket. Ship. wt. 2 lbs. No. 87, \$2.95 (Shpg. chgs. 35c)

250 Power Telescope Lens Kit

Make your own 6 ft. telescope. Kit 2" diam. 75" focal length, polished objective lens and eyepieces. Magnifies 50X to 250X. Full instructions. No. 123, \$2.95 (Shpg. chgs. 10c)

Super Alnico Magnet

Powerful 4 oz. Alnico steel magnet. Lifts 5 lbs. easily. Measures 1 3/4" x 1 1/2". Experimenters will find hundreds of uses. Usually costs \$3.50 No. 86, \$1.50 (Shpg. Chgs. 10c)

WATTHOUR METER



Leading makes—reconditioned. Ideal for trailer parks, 100-110 volts, 60 cycles, 2-wire A.C. 5 amp. Heavy metal case 8 1/2" x 6 1/4" x 5". Easy to install. Ship. wt. 14 lbs.
ITEM NO. 33
NOW ONLY \$4.50
(P.P. & Hdg. Chgs. \$1.25)

HUDSON SPECIALTIES CO., 160 W. 14th St. Dept. RE-9-58, New York 7, N. Y.
I am enclosing full remittance for items circled below. (Be sure to include shipping charges.)
87 33 86 123 130 131
Name Please Print Clearly
Address
City Zone State

RADIO-ELECTRONIC CIRCUITS (Continued)

the unit works: With the dpdt switch in the PHONO position, the phono-motor switch turns on the motor and the relay pull-in couples the ac line to the amplifier. When the phono switch goes off, the relay opens and turns the amplifier off.

With the dpdt switch in the TUNER position, the ac line is fed directly to

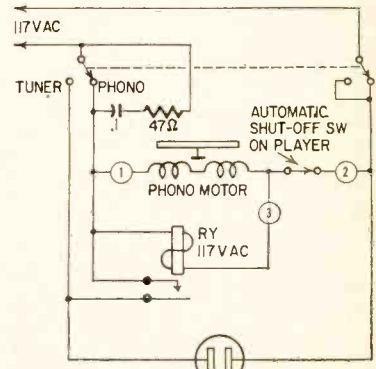

AC RECEPT FOR AMPL

the amplifier and the phono switch has no effect.

The 0.1- μ f capacitor and 47-ohm resistor damp out the switch clicks. The autoswitch could be built into a small utility box or wired into the amplifier chassis. Points 1, 2 and 3 may be wired through a plug-and-socket connector so the player can be disconnected at will.—T. Q. Sarmiento

TRANSISTOR POWER AMPLIFIERS

Here are two circuits using audio power transistors that deliver 5 and 12 watts output, respectively. The 5-watt circuit uses a 2N301 or 2N301-A as a single-ended class-A amplifier (Fig. 1)

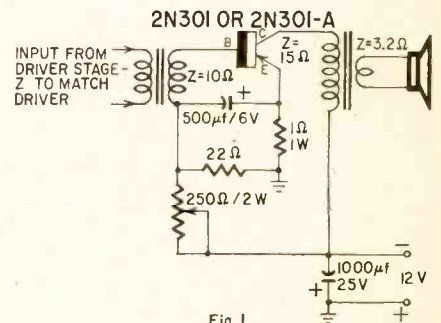

Fig. 1

while the 12-watt circuit uses two of these transistors in class-B push-pull (Fig. 2).

To insure stable low-distortion op-

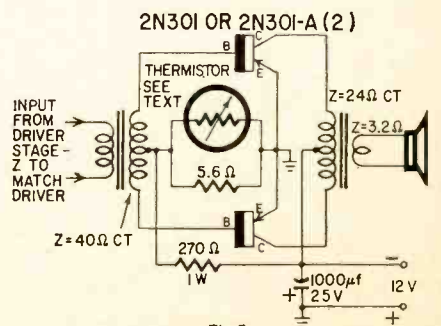
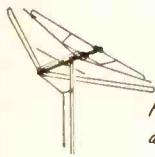

Fig. 2



TRIO[®]
COLORITE



For color or black and white in areas formerly using Conicals and Conical Yagis

TRIO[®]
COLOR ROYAL

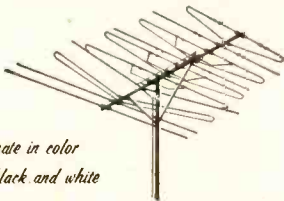

For the Ultimate in color reception or black and white

TRIO COLOR ANTENNAS FEATURE THE

magna-chrome
element system

FOR:
high forward gain

Sharper, Clearer Pictures High Signal-to-Noise Ratio
flat frequency response

Improved Contrast on Black & White
Perfect Reproduction of the Color Signal

highest front-to-back ratio

For Freedom From Co-channel Interference

TRIO[®] Manufacturing Company
GRIGGSVILLE, ILLINOIS

Export Sales Div., Scheel International Inc.,
5909 N. Lincoln Ave., Chicago, U.S.A.
Cable Address: HARSCHTEL

SEPTEMBER, 1958

RADIO-ELECTRONIC CIRCUITS (Continued)

eration of the Fig. 1 circuit, degeneration in the emitter circuit is provided by the unbypassed 1-ohm resistor. In the push-pull circuit of Fig. 2 a different problem arises—thermal runaway. This can occur when transistors are operated near their maximum collector-voltage rating. The thermistor reduces base-to-emitter forward voltage in proportion to the transistor's operating temperature. Here a unit rated at 28.25 ohms at 0° C., 10 ohms at 25° C. and 4.06 ohms at 50° C. is used.

In both circuits it is important that the transistor mounting flange, which serves as the collector connection, be

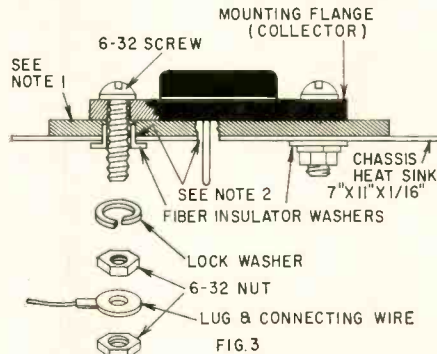

NOTE 1: 0.002" MICA OR 1/8" THICK ALUMINUM INSULATOR, DRILLED, OR PUNCHED WITH BURRS REMOVED, AND THEN ANODIZED.

NOTE 2: REMOVE BURRS FROM CHASSIS HOLES.

fastened to a heat sink. Where this heat sink is the chassis and is connected to the positive terminal of the voltage supply, the transistors must be insulated from the chassis. This is done with either a 1/8-inch anodized aluminum insulator or a .002-inch mica insulator between the mounting flange and the chassis. See Fig. 3. These two methods provide insulation without impairing the chassis' heat-sink function. And don't forget to insulate the mounting bolt and nut from the chassis with fiber washers.

Both circuits appeared in an RCA transistor specification sheet giving tentative data on the 2N301 and 2N301-A power transistors. END

50 Years Ago

In Gernsback Publications

HUGO GERNSBACK, Founder

Modern Electrics	1908
Wireless Association of America	1908
Electrical Experimenter	1913
Radio News	1919
Science & Invention	1920
Television	1927
Radio-Craft	1929
Short-Wave Craft	1930
Television News	1931

Some larger libraries still have copies of Modern Electrics on file for interested readers.

In September, 1908, Modern Electrics

Modern Electric Tubes, by H. Gernsback.
Thousand Words a Minute.

A Tesla Coil, by A. C. Austin, Jr.
Loud-Speaking 'Phone, by the Berlin Correspondent.

Wireless Telephone Philadelphia-Newark.
Wireless Station on Waldorf-Astoria.

The Construction of a Transmitting Tuning Coil, by A. C. Austin, Jr.

An Oscillation Responder, by John L. Hogan, Jr.

SUCCESS SECRET NO. 1!

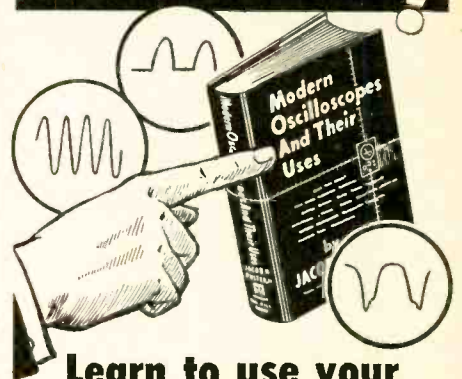

Learn to use your
OSCILLOSCOPE
fast & accurately
ON ALL TYPES
OF WORK!



A complete, easily understood guide to using the handiest service instrument of them all!

A good man with a 'scope is a valuable man indeed . . . and here is a famous book that gets right down to brass tacks in helping you be that fellow!

In clear, easily understood terms MODERN OSCILLOSCOPES AND THEIR USES teaches you when, where and how to use oscilloscopes . . . how to interpret patterns . . . how to handle all types of jobs lots better and faster.

No difficult mathematics! No complicated theory. It's a real "how to" book. First you learn all about 'scopes. Then you learn exactly how to use them in the lab, in teaching and on all types of AM, FM, hi-fi and television service—from locating troubles in a jiffy to handling tough realignment jobs. You even learn about using 'scopes on color TV problems!

HANDLE SERVICE JOBS BETTER . . . AND FASTER!

Each operation is explained step by step, so you learn to make the proper connections. You learn to adjust circuit components for proper results. You learn to set the controls and how to analyze oscilloscope patterns. 370 clear illustrations including dozens of typical pattern photos explain many problems plainer than words.

Remember! 'Scope experts get better jobs . . . earn bigger pay. This is the book that can help you be one!

—PRACTICE 10 DAYS—FREE!

RIEHNART & CO., INC., Dept. RE-98
232 Madison Ave., New York 16, N.Y.

Send MODERN OSCILLOSCOPES AND THEIR USES for 10-day FREE EXAMINATION. If I like the book, I will send \$6.50 (plus postage) promptly in full payment. If not, I will return it in 10 days and owe you nothing. (SAVE! Send \$6.50 with order and we pay postage. Same 10-day return privilege with money refunded.)

Name.....

Address.....

City, Zone, State.....

OUTSIDE U.S.A.—\$7.00 in cash with order. Money back if you return book in 10 days.



Popular and Fast Moving . . .

"ILLINI

ELECTROMITE CONDENSERS"

Time Tested
Quality.

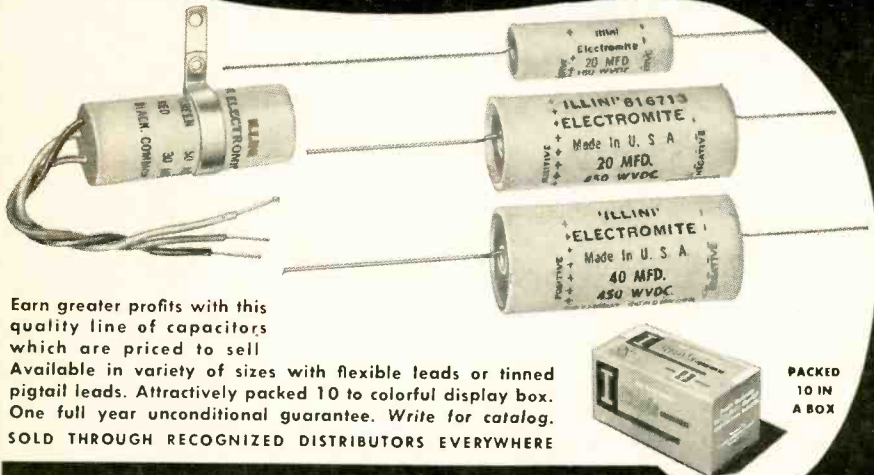

Earn greater profits with this quality line of capacitors which are priced to sell. Available in variety of sizes with flexible leads or tinned pigtail leads. Attractively packed 10 to colorful display box. One full year unconditional guarantee. Write for catalog. SOLD THROUGH RECOGNIZED DISTRIBUTORS EVERYWHERE



Telephone: EVerglade 4-1300

ILLINOIS

CONDENSER COMPANY

1616 N. Throop Street • Chicago 22, Illinois

Technotes



TAPE RECORDER HINTS

On Ampro model 758 recorders a common complaint is a whining noise in the takeup reel. To cure, disassemble the reel and clean the felt clutch and glue it to the knurled side of the clutch disc. Grease the felt clutch lightly and reassemble.

Bell & Howell models 130, 130A and 300S have trouble with a whistling noise when volume is turned up. Replace the 10-megohm resistor at the first grid with an 8.2-megohm unit and the whistle will disappear.

Noise in the amplifier is a complaint with the Keystone K400. Sometimes it turns out to be tube trouble, but frequently this noise comes from the contacts in the PA phone jack. Either disassemble the jack and clean its contacts thoroughly or install a new one.—*Thomas L. Bartholomew*

G-E 21C111

After replacing the picture tube in this set, I happened to check the vertical hold control and found that it would

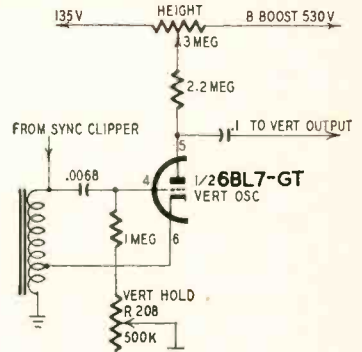

make the picture roll in only one direction. Checking further, I discovered that the control (R208), a 500,000-ohm pot, measured only 400,000 ohms. A quick replacement brought things back to normal.—*A. C. Hepperlen*

FRINGE SOUND PROBLEM

After a recent TV antenna installation in our fringe area, a servicing problem arose that may be of interest to other technicians in similar areas. A stacked broad-band high-gain vhf antenna had been installed and the receiver checked for performance on the three closest stations, channels 4, 6 and 10. The video signal came in nicely on all channels but the audio on channel 10 was badly distorted, sounding somewhat like a gassy output tube. However, the sound on channels 4 and 6 was clean, and we pulled the set to the shop.

Since the receiver used a strip type

RADIO-ELECTRONICS

"NO-NOISE" BIG 3

Beware Of Cheap Substitutes!



NO-NOISE NEW RUBBER COAT SPRAY

6 Oz. Spray Can Net To Servicemen \$3.25

- Insulates where applied
- Protects indefinitely
- Prevents arcing, shorting, corrosion
- Waterproofs thoroughly
- Non-inflammable
- Contains no plastic

NO-NOISE VOLUME CONTROL and CONTACT RESTORER

- Cleans
- Protects
- Lubricates

NOT A CARBON TET SOLUTION



2 Oz. Bottle Net To Servicemen \$1.00
6 Oz. Spray Can Net To Servicemen \$2.25



NO-NOISE TUNER-TONIC

With PERMA-FILM

- Economical—a little does a lot!
- Cleans, lubricates, restores all tuners, including wafer type.
- Non-toxic, non-inflammable.
- Use for TV, radio and FM

6 Oz. Aerosol Can Net To Servicemen \$3.25

ELECTRONIC CHEMICAL CORP.
813 Communipaw Avenue Jersey City 4, N. J.

LEARN

Television RADIO-COLOR-TV Electricity ELECTRONICS

IN THE GREAT SHOPS OF COYNE

TRAIN QUICKLY! OLDEST, BEST EQUIPPED SCHOOL OF ITS KIND IN U.S.

Veterans and Non-Veterans—Get practical training in top opportunity fields. Prepare now for a better job and a real future. Advanced education or previous experience not needed. Employment service to graduates.

Enroll NOW—Pay Later

Finance Plan and Easy Payment Plan. Also Part Time Employment help for students. Training in Refrigeration and Electric Appliances can be included.

FREE BOOK Clip coupon for Big Free Illustrated Book. No obligation and No Salesman Will Call. Act NOW.

B. W. Cooke, Jr., President

COYNE ELECTRICAL SCHOOL OPERATED NOT FOR PROFIT Established 1899 500 S. Paulina, Chicago Dept. 68-5C

B. W. COOKE, Jr., Pres.
COYNE Electrical School
500 S. Paulina St., Chicago 12, Ill. Dept. 68-5C

Send FREE BOOK and full details on:
 TELEVISION-RADIO
 ELECTRICITY-ELECTRONICS

NAME.....
ADDRESS.....
CITY.....STATE.....

increase your know-how
... increase your income
RIDER BOOKS AND MANUALS

PORTABLE AND CLOCK RADIOS, by Ben Crissee and David Gnessin. You can learn all about portable and clock radios—their circuitry, their repair, in this modern book. Beginning with typical portable radio circuits, emphasis is placed on filament circuitry and how major problems of current dispersion are handled. Transistor circuitry is covered. Stress is placed on portable radio power supplies for battery circuits and battery and AC-DC circuits. Numerous battery testing techniques explained. Covers repair, replacement and alignment plus a detailed discussion of probable mechanical troubles, replacement procedures and short-cuts. Tips on extending the life of the set are discussed. Clock radios, their circuitry, a wide variety of clock movements, how to adjust them and locate defects also covered. Tips on cleaning and lubricating clock mechanisms. #224. \$2.75.

HOME AIR CONDITIONING—Installation & Repair by J. Derman, F. Makstein, H. Seaman. This modern, completely practical text by three experts in the field of home air conditioning, enables anyone to understand the organization, operation, installation and repair of all types of home air conditioners. Starting with the principles of the process of cooling air, it covers all facets of home air conditioners.

Both electrical and mechanical components are fully identified, described and illustrated, permitting instant recognition of the parts. Function of each part, its contribution to the entire unit is explained in detail. Troubleshooting and repair techniques are completely covered plus information on how to pinpoint specific troubles by their symptoms. Typical window & package installations and smaller commercial installations are discussed. Tells how to select the proper unit to meet the requirements set by windows, walls, floors, ceilings, the cubic dimensions of the space to be served and the number of people for which the unit will be used. An extremely practical and useful guide for all who seek entry into the lucrative air conditioning field. #211. \$3.50.

REPAIRING HI-FI SYSTEMS, by David Fidelman. This book deals with finding the troubles and repairing faults in hi-fi equipment with no test instruments—simple equipment—and elaborate equipment. Typical troubles are analyzed and repaired through a system of logical steps. Soft cover. 212 pp., illus. #205. \$3.90.

REPAIRING TELEVISION RECEIVERS, by Cyrus Glickstein. The most modern completely practical book, written by an expert with long experience in television receiver repair. Devoted to troubleshooting and repair techniques which are modern, yet down-to-earth. Covers the use of simple as well as elaborate test equipment of all kinds. Profusely illustrated. Soft cover, 212 pp., 5 1/2" x 8 1/2", illus. #191. Only \$4.40.

GAS TUBES edited by Alexander Schure, Ph.D. The growing importance of gas tubes in industrial electronic applications makes a thorough knowledge of them a must. This book, the latest in the famous Electronics Technology Series, describes the various types of gas tubes, their physical construction and applications in a remarkably thorough and understandable manner. Starting with an explanation of ionization in gases, the text covers the role of ions, gas conduction and arc discharge in gas tubes. Gaseous rectifiers are fully described and compared with high vacuum rectifiers. The effect of gas on the thermionic tube and the value of mercury vapor in rectifiers are covered. The text details the use of gas tubes as highly effective voltage regulators with examples of the circuitry involved. Triode thyratrons, their construction, operation and application are explained. Other types of gas tubes and their related circuitry covered in this text include: gas-filled phototubes, cold-cathode gas tubes, mercury pool rectifiers and ignitrons. #166-24. \$1.50



NOW AVAILABLE TV 23
Finest TV Service Information Anywhere
only \$21.00

Rider Books are sold by parts distributors and bookstores. Look for the familiar Rider Bookseller. It carries a wealth of electronic know-how in the many titles covering every phase of radio, TV, audio and electronics. There's a Rider Book that will make servicing more profitable, increase your income. If these books are not available, order direct: RE-9



JOHN F. RIDER PUBLISHER, INC.
116 West 14th Street, New York 11, N. Y.

TECHNOTES (Continued)

turret tuner and audio was distorted only on channel 10, we checked the channel-10 strip first. It was OK. Then the entire front end was aligned, but without success—distortion was just as bad as before.

After digging out the schematic, I began checking voltages and components in the sound if, detector, and first audio and audio output stages. A careful resistance check of the output stage disclosed a bad grid-return resistor—it was supposed to be 180,000 ohms but had gone up to 350,000.

The answer to the distortion problem suddenly became obvious. Channel 10 is much stronger in this area than channel 4 or 6 and the stronger signal was causing a large voltage drop across the bad grid resistor, resulting in too much bias voltage on the output tube—and causing distortion.—Warren J. Smith

BENDIX KS21E

The set was pulled to the shop for snow on all channels which increased as the receiver warmed up. The tuner was the obvious suspect, but no discrepancy in voltages could be found and tube substitution did not help. Following through the if strip, the only

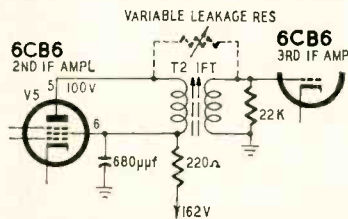

flaw was at the plate and screen of the second if amplifier, a 6CB6. Voltages were lower than normal. The plate read only 100 instead of 120, but the B-plus line was high (162 instead of the rated 155 volts). Where was the voltage going?

A check of the second if transformer revealed a 10-megohm short between windings. Apparently as the set warmed up, the leakage became more pronounced. When the transformer was replaced, voltages returned to normal and the snow disappeared.—James A. McRoberts

END



"It's rather difficult to describe, but it looks like this!"

It's easy to learn all about
• DIGITAL COMPUTERS •
• PULSES •

THE RIDER 'PICTURE-BOOK' WAY

Rider 'picture-book' training courses are the easiest, quickest, most economical way to increase your electronic knowledge. Text is written in down-to-earth English and explanations are thorough enough to satisfy the most critical engineer. Fundamentals are presented idea-by-idea, page-by-page, permitting you to build your knowledge step-by-step. Specially conceived, easily understood illustrations support the text and make each subject crystal clear. These two new 'picture-book' courses are your springboard to progress in the exciting electronics field.

BASICS OF DIGITAL COMPUTERS

by John S. Murphy

catapults you into the exciting digital computer field. If you have a knowledge of the fundamentals of electronics, you can master the basics of digital computers and understand the details of any specific digital computer with this new 3 volume 'picture-book' course. Written by an expert in the computer field, text matter has been tested and proven in the training of computer field engineers and technicians. More than 350 illustrations support the text.

This 3 volume set starts with digital computer system background, progresses to the components and units of a system, and presents the details of transition from communication electronics to computer electronics. It ties together logical building blocks and elemental circuits through typical examples combining their use. Finally, the course deals with the operation of computers covering the major units in a computer from a system's point-of-view.

For all who wish to enter this exciting new field, or broaden their knowledge of it, Basics of Digital Computers is *must reading*. Ideal as a starting point for technicians, engineers, programming personnel, field sales engineers, maintenance men.

#196, 3 volumes, soft covers, \$6.95 per set
#196-H, cloth bound, 3 vols. in one binding, \$7.95

BASIC PULSES

by Irving Gottlieb, P.E.

Ever since the time Samuel F. B. Morse first opened and closed a switch transmitting series of pulses from Washington to Baltimore, pulses and pulse techniques have become vital to the successful application and expansion of electronic technology. Pulses direct the high speed operation of all types of computers; underlie the functioning of radar systems for early warning, recognition, fire control—in general the gathering of information from distant points by electromagnetic radiation means. Pulses guide industrial operations that require split-second timing for mass production—counting, sorting and testing. Virtually every form of electronic timing involves the use of pulses. The functioning of every television system—over the air or closed circuit—depends on correct pulse frequencies, duration and shape; in fact the application of pulses recognizes almost no boundaries in the field of electronics. You can learn all about pulses and expand your opportunities in these fields quickly, easily and economically with this one volume 'picture-book' training course—all that is necessary is a knowledge of the fundamentals of electronics. Basic Pulses is a thorough crystal-clear presentation of the nature, measurement and application of pulses—what they are and how they are used.

Basic Pulses covers each facet of pulses. For example, 25 individual aspects are covered in the section devoted to waveshaping techniques. 24 different types of pulse generators are detailed. Every equation is made completely understandable by numerical examples. A glossary of pulse terms is included.

#216, soft cover, 176 pp. \$3.50

Basics of Digital Computers and Basic Pulses are now available. If you cannot get them where you normally buy your books, order direct.

10-day unconditional money-back guarantee

JOHN F. RIDER PUBLISHER, INC.
116 West 14th Street, N. Y. 11, N. Y.

I enclose \$..... Please send me:

3 vol. **BASICS OF DIGITAL COMPUTERS** set (soft cover) \$6.95 Cloth bound edition. \$7.95

BASIC PULSES (soft cover) \$3.50.

I understand I may return the books in 10 days for refund of full purchase price if not satisfied.

Name.....

Address.....

City..... Zone..... State.....

RE-9

OSCILLOSCOPE COURTESY OF
PRECISION APPARATUS COMPANY, INC.

I used to
WATCH
the music
on the
oscilloscope...



... but a
NORELCO®
speaker
made me

LISTEN!

Every time I bought a record, I used to set up the calibrated microphone, connect the oscilloscope, start the music with bated breath, and keep my eyes glued to the screen. If anything on the 'scope pattern looked suspicious (something always did), I would start checking tubes, voltages and crossover frequencies, and examine the record under a microscope.

Then, at the house of a musician friend, I heard a NORELCO loudspeaker. I was suddenly carried away by the sheer joy of listening! What lovely sound! Clean, tight bass; creamy smooth highs; crisply defined middles... it was music!

I rushed out to the nearest hi-fi dealer, bought my own NORELCO speaker, took it right home... and I am a different person today. Man, just listen to that music!

(You can change your hi-fi life, too—just write to North American Philips Co., Inc., High Fidelity Products Division, 230 Duffy Avenue, Hicksville, Long Island, N. Y.)

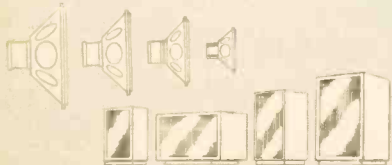

a complete line of 5" to 12" high-fidelity speakers and acoustically engineered enclosures

Patents



DIRECT-COUPLED TRANSISTOR AMPLIFIER

Patent No. 2,822,434

Robert J. Ehret (Assigned to Minneapolis Honeywell Regulator Co., Minneapolis, Minn.)

Direct coupling in electronic equipment is attractive from the standpoint of economy, compactness and simplicity. This transistor circuit may have as many as four or more stages yet be very stable. Temperature effects

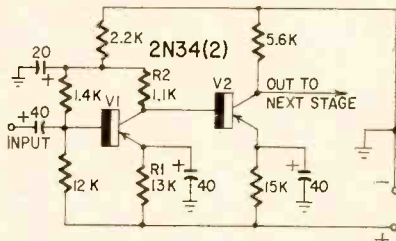

are balanced out also. For example, assume that a temperature rise increases V1's collector current and produces a greater drop across R2. Then V2's base goes more positive to cancel the tendency for this transistor's collector current to rise also.

Each stage has less than unity voltage (dc) gain because each collector load is lower than the corresponding emitter resistor. However, there is considerable current (ac) gain, depending upon the transistor's beta. A single battery powers the entire amplifier.

LOOK-LISTEN BOOK

Patent No. 2,822,425

Walter R. Hicks, Manhasset, N. Y.

This book enables the reader to see and hear. Its pages are coated with magnetic tape along the edges. A reproducer is moved over the strips to hear the appropriate message. The idea is use-

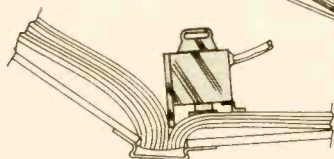
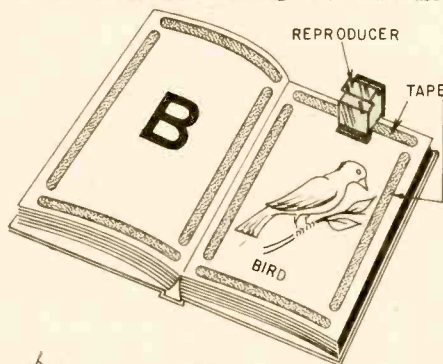

ful for teaching children new sounds and words or for studying a foreign language.

The chief problem is the mechanical arrangement by which the reproducer may be held in place as it is moved. One method is shown in the diagram.

Amplifier and speaker may be placed in a separate unit, or a local oscillator can be used to broadcast to a nearby radio.

HI-FI OUTPUT TRANSFORMER

Patent No. 2,815,408

David Hafler, Philadelphia, Pa.

This inventor finds that high power with low

Stay ahead of the crowd

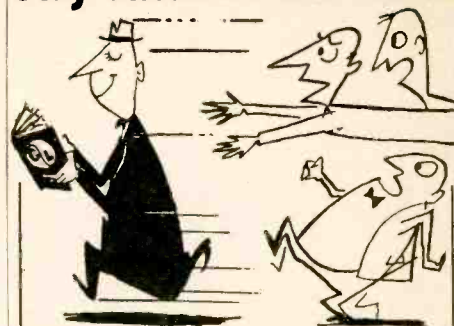

Service technician? Hi-fi fan? Experimenter? Hobbyist? Beginner? Here's a library of low-cost books to help you work faster, get better performance, or find the tips you need to be just a little bit better on your job—or get a little bit more fun out of your hobby.

SERVICING AND TEST INSTRUMENTS

- Oscilloscope Techniques—By Alfred Haas. 224 pages. No. 72—\$2.90
- TV and Radio Tube Troubles—By Sol Heller. 244 pages. No. 68—\$2.90
- Servicing Color TV—By Robert G. Middleton. 224 pages. No. 65—\$2.90
- Rapid TV Repair—G. Warren Heath. 224 pages. No. 60—\$2.90
- Servicing Record Changers—By Harry Mileaf. 224 pages. No. 59—\$2.90
- The V.T.V.M.—By Rhys Samuel. 224 pages. No. 57—\$2.50
- Sweep and Marker Generators for Television and Radio—By Robert G. Middleton. 224 pages. No. 55—\$2.50
- Probes—By Bruno Zucconi and Martin Clifford. 224 pages. No. 54—\$2.50
- The Oscilloscope—By George Zwick. 192 pages. No. 52—\$2.25
- TV Repair Techniques—128 pages. No. 50—\$1.50
- Radio and TV Test Instruments—128 pages. No. 49—\$1.50
- Television Technotes—128 pages. No. 46—\$1.50

TRANSISTORS

- Transistors—Theory and Practice—By Rufus P. Turner. 144 pages. No. 51—\$2.00
- Transistor Circuits—By Rufus P. Turner. 160 pages. No. 63—\$2.75
- Transistor Techniques—96 pages. No. 61—\$1.50

HIGH FIDELITY

- Audio Design Handbook—By H. A. Hartley. 224 pages. No. 71—\$2.90
- Elements of Tape Recorder Circuits—By Herman Burstein and Henry C. Pollak. 224 pages. No. 67—\$2.90
- Understanding Hi-Fi Circuits—By Norman H. Crowhurst. 224 pages. No. 64—\$2.90
- Maintaining Hi-Fi Equipment—By Joseph Marshall. 224 pages. No. 58—\$2.90
- High-Fidelity Circuit Design—By Norman H. Crowhurst and George Fletcher Cooper. 304 pages. Deluxe hard cover ed. No. 56—\$5.95
- Basic Audio Course—By Donald C. Hoefler. 224 pages. No. 66—\$2.75
- High-Fidelity—Design, Construction, Measurements—128 pages. No. 48—\$1.50

THEORY AND PRACTICE

- TV—It's A Cinch!—By E. Aisberg. 224 pages. No. 62—\$2.90
- Radio and TV Hints—112 pages. No. 47—\$1.00
- Radio Tube Fundamentals—By George Christ. 96 pages. No. 45—\$1.00
- Basic Radio Course—By John T. Frye. 176 pages. Hard cover ed. No. 44—\$2.25

HOBBIES

- Electronic Puzzles and Games—By Matthew Mandl. 128 pages. No. 70—\$1.95
- Electronic Hobbyists' Handbook—By Rufus P. Turner. 160 pages. No. 69—\$2.50
- Radio-Control Handbook—By Howard G. McEntee. 192 pages. No. 53—\$2.25
- Model Control by Radio—By Edward L. Safford, Jr. 112 pages. No. 43—\$1.00

All books paper-bound unless otherwise stated

Gernsback Library Books are on sale at all leading parts distributors.

If your dealer doesn't carry G/L books write to us at 154 West 14th Street, New York 11, N.Y.

OPPORTUNITY ADLETS

Rates—50¢ per word (including name, address and initials). Minimum ad 10 words. Cash must accompany all ads except those placed by accredited agencies. Discount, 10% for 12 consecutive issues. Misleading or objectionable ads not accepted. Copy for November issue must reach us before September 15, 1958.

RADIO-ELECTRONICS,
154 West 14 St., New York 11, N. Y.

HIGH-FIDELITY SPEAKERS REPAIRED. AMPRITE
Speaker Service, 70 Vesey St., New York 7, N. Y.
BA 7-2580.

CASH PAID! Sell your surplus electronic tubes. Want unused, clean transmitting, special purpose, receiving, TV types, magnetrons, klystrons, broadcast, etc. Also want military & commercial lab test and communications gear. We swap too, for tubes or choice equipment. Send specific details in first letter. For a fair deal write, wire or telephone: **BARTY,** 512 Broadway, New York 12, N. Y. Walker 5-7000.

RECORDERS, Hi-Fi, Tapes, Free Wholesale Catalogue.
CARSTON, 215-T East 88th St., New York 28, N. Y.

STEREO TAPE RENTALS. For the very best at lowest prices. Write **CALIFORNIA TAPED MUSIC ASSN.,** 1971 Cordillera Road, Redwood City, Calif.

DISCOUNTS UP TO 50% on Hi-Fi amplifiers, tuners, speakers, tape recorders, individual quotations only, no catalogues. **CLASSIFIED HI-FI EXCHANGE,** 2057 Coney Island Ave., Brooklyn, N. Y.

LABORATORY QUALITY equipment and Military Surplus Electronics bought, sold. **ENGINEERING ASSOCIATES,** 431 Patterson Road, Dayton 9, Ohio.

DIAGRAMS FOR REPAIRING RADIOS \$1. Television \$2. Give make, Model. **DIAGRAM SERVICE,** Box 672-R, Hartford 1, Conn.

SAVE MONEY! Get our price list on all types Radio and TV tubes at Mfrs. prices! 100% guaranteed, all brand new and unused, no mechanical or electrical rejects, nor washed or rebranded! 24 hour service! Write **UNITED RADIO COMPANY,** 58 Market St., Newark, N. J.

ALL MAKES OF ELECTRICAL INSTRUMENTS AND TESTING equipment repaired. **HAZELTON INSTRUMENT CO.,** 128 Liberty Street, New York, N. Y.

TELEVISION Tuner Repairs. DAN'S TELEVISION LABORATORY, 619A Sunrise Highway, Babylon, N. Y.

REPRINTS available of any article in **RADIO-ELECTRONICS.** Reasonable rates. High quality. **PASSANT PRINTING CO.,** 250 West 49th St., New York, N. Y.

"VHF ROUND-UP!" Don't forget October 11. That's the date of Syracuse VHF Round-up. All the big DX men will be there, so don't stay home and listen to a dead band. Contact **W2EMW** 18 Homeland Dr., No. Syracuse, N. Y.

DISCOUNTS TO 50%, recorders, tapes, hi-fi components, consoles, photograph equipment. Request specific prices only. **LONG ISLAND AUDIO & CAMERA EXCHANGE,** 3 Bay 26th St., Brooklyn 14-R, N. Y.

DIAGRAMS! Repair Information! Radios—Amplifiers—Recorders \$1. Televisions \$1.50. Give make, model, chassis. **TV MILITARY,** Box 101EA, Hicksville, N. Y.

HIGH-PAYING JOBS. opportunities; foreign, USA. All Trades. Companies pay fare. For information, write Dept. 57U. **NATIONAL EMPLOYMENT INFORMATION,** 1020 Broad, Newark, N. J.

PROFESSIONAL Electronic Projects—Organs, Timers, Intermittents, Counter, etc. \$1 each. List Free. **PARKS,** Box 1665, Lake City Station, Seattle 55, Wash.

15 TESTED 1-TUBE CIRCUITS, transistor experiments and catalog—25¢. **LABORATORIES 1131-B** Valota, Redwood City, Calif.

What Articles Would You Like to See Published in RADIO-ELECTRONICS?

Maybe You're the Man to Write Them. Ask for An Author's Guide.

RADIO-ELECTRONICS

154 West 14th St. New York 11, N. Y.

47 RADIO PROJECTS 75¢

Plus "White's Radio Log"

Think of it... 47 electronics projects you can build... explained with diagrams, photographs and step-by-step instructions, plus "White's Radio Log," a directory listing U.S. and Canadian A.M., F.M. and TV stations by call letters, locations, kilocycles and power and over 1,000 world-wide short-wave stations. Terrific value! Get this 192-page handbook, **RADIO-TV EXPERIMENTER,** No. 668, at newsstands 75¢ or direct from: **SCIENCE & MECHANICS,** 450 E. Ohio St., Dept. 796, Chicago 11

PATENTS (Continued)

distortion is possible when a transformer is wound as described here. A typical transformer shows only 1-db distortion over a range of 7 cycles to 70 kc at 50 watts output.

As shown in the diagram, the windings are sectionalized. Primaries and secondaries are wound alternately so that each serves as a shield for the others. Arrows show the rotational sense of each winding.

Each secondary is balanced with respect to the primary for true push-pull. For example, S1 is acted upon by P1 (immediately over it) and by

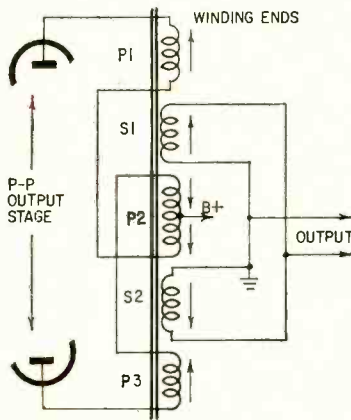

one half of P2 (immediately beneath it). Although P1, P2 are oppositely wound, they conduct current from different tubes so their effect is additive.

The only unbalance occurs for dc resistance and capacitance. The several coils are superimposed one over the other, with P3 nearest the core. Thus each coil must have a different resistance and dc capacitance. This disadvantage is compensated by the decrease in leakage, intercoil capacitance and shunt distributed capacitance.

END

CORRECTIONS

There is an error in the value of cathode capacitor C_k in Fig. 1 of "Final Touchup for Your Amplifier" in the May issue. The correct value of C_k is .005 μ f. Make this change on the diagram and in the eleventh line of the second column of text on page 54.

Our thanks to John Addison, of Ormond Beach, Fla., for reporting the error.

In the article "How the Stereo Disc Works" in the July issue, the Electro-Voice 20 series stereo cartridge is erroneously referred to and discussed as a crystal type. The manufacturer has informed us that this cartridge uses barium-titanate ceramic generating elements.

There is an omission in the circuit of the R-C-L bridge, page 80 of the August issue, that makes it inoperative as a Hay inductance bridge. There should be a connection between the lower end of R11 and the bottom left contact of the M-H switch (S3).

It took a sharp-eyed telephone man, Edmund Sheffield, Jr., of Pacific Telephone & Telegraph, to spot the error.

In Figs. 1 and 3 of the article "Gating with Diodes" in the August issue, the diodes were inadvertently reversed. Our thanks to Richard Kolker of Huntington, N. Y., for reporting the error.

FREE TV

Some customers are very Clever.

They need immediate service Ever;

But pay their bills as often—

Never! —Phyllis Barlow

"TAB" Tubes Tested, Inspected, Boxed

New and used Gov't & Mfrs.

Surplus! 6 Mos. Guarantee! No Rejects

Orders \$10 or more. Receiving types only vnd. 48 states

0A2	.80	6B16	.72	12A7	.59	117Z3	.69
0B2	.72	6BK7	.99	12AT7	.89	117Z6	1.10
0C3	.84	6BL7	1.95	12AU6	.63	2C51	2.65
0D4	.80	6BM6	1.08	12B6	.69	2D1	6.68
0Z4	.50	6BQ6	1.19	12AX7	.79	3D23	5.00
1A7	1.00	6BZ7	1.25	12BA6	.65	717A	5/51
1T4	.78	6DD5	1.49	12BF6	.49	12Z5	29.00
1R5	.78	6C5	.69	12BH7	.99	4X150	19.00
1S4	.78	6C86	.80	12BE6	.59	4E27	7.00
1T4	.78	6DD5	1.49	12BF6	.49	4R60	25.50
1U4	4/5	6H6	.99	12EH7	.99	4X150	19.00
1U5	.89	6J5	.59	12BY7	1.00	4X250	35.00
1X2A	.68	6J6	.59	12BZ7	.59	4X500	38.00
3Q4	.68	6K6	.59	12C6	1.45	5B1	3.98
3Q5	.86	6K7	.79	12SA7	.69	5B4	1.98
3S4	.68	6L6	1.19	12SQ7	.89	5T	4.00
3V4	.99	6S4	.59	12S7	.89	100T	7.00
5R4	1.25	6SR	.99	12SJ7	.75	250T	20.00
5U4	.59	6SA7	.59	12SK7	.75	388A	1.00
5V4	.89	6SB7	1.19	12S7	.89	418A	14.00
5Y3	.59	6SC7	.89	19B66	2.15	450T	43.00
6AB4	.59	6SG7	.79	19T8	1.16	807	1.10
6AC7	.70	6SH7	1.49	20A7	1.39	808	1.00
6AG6	.89	6SK7	.69	25L6	.72	809	3.00
6AH6	.99	6S7	.72	25W4	.77	810	10.00
6AK5	.69	6SL7	.89	25Z5	3.2	811	3.00
6AL5	.59	6SN7	2/51	25L6	.72	812	3.00
6AQ5	.66	6SQ7	.74	EL34	.34	813	9.00
6AS7	3.00	6SR7	.79	EL37	2.49	814	2.45
6AT6	.49	6T6	.98	35L6	.69	350	5.00
6AU4	1.29	6U8	.98	35W4	.52	829B	8.00
6AU5	1.19	6V6	1.39	35Y4	.69	832A	7.00
6AU6	.79	6W4	.79	50A5	.69	834	4.00
6AX4	1.79	6W6	.89	50A5	.69	8146	4.00
6BA6	.59	6X4	.39	50B5	.69	5879	1.20
6BA7	1.00	6X5	.39	50B5	.69	5875	1.00
6BE6	.69	6Y6	.89	50L6	.69	5550	3.90
6BE6	.59	7N7	.89	KT66	3.29	5842	11.00
6BG6	1.50	12AL5	.59	5	.89	5842	1.00
6BH6	.79	12AQ5	.75	80	.59	5894	14.00

Write for Complete Tube List! Discounts to Qty. Buyers TUBES WANTED! WE BUY! SELL & TRADE!

TOROID COMPUTER LOGIC TRANSFORMER

Toroid—Use as gate or counting circuit or logic drive memory device. 3 windings—20ma/2 microsecond switching time would cure. "IBM" design, fits 8 pin miniature socket. \$1.50 each. 5 for \$5 postpaid.



DIAMOND PHONO-NEEDLES! Postpaid 48 States! REGISTERED ONE YR. GUARANTEED BY THE MFGR! ALL MAKES LISTED—ONE 150000 TWO DIAMONDS \$3.4 DIAMOND SAPHIRE \$8. PLEASE SEND CARTRIDGE NAME & NUMBER

FINEST HI-FI RECORDING TAPE

1200 FT.—7" Reel \$1.45 Lots of 3 Money Back Gtd. Highest quality controlled plastic base made by new "Erin" process. Precision coated & Silt. Gtd. Constant output. Spice Free. Freq. 7 1/2 IPS 40-15Kc. 400 150. Each postpaid \$1.00. New 1st quality "Wylar" 2400 FT.—7" Reel Ferro "Erin" Gloss Process Recording tape \$4.49, 3/\$12.

NEW GTD: RADIO & T.V. RECTIFIERS

35MA 40c @ .6 for \$2; 65MA 45c @ .5 for \$2; 75MA 49c @ .5 for \$2; 100MA 59c @ .6 for \$3; 150MA 70c @ .8 for \$5; 250MA 79c @ .6 for \$4; 400MA 88c @ .5 for \$4; 500MA \$1.00 @ .8 for \$7; 400MA \$1.10 @ .5 for \$5; 500MA \$1.35 @ .4 for \$5; 65MA/260V \$1.10 @ .5 for \$5; 100MA/260V \$1.25 \$1.75, 3/\$5. Order \$10. Postpaid 48 States! Mfrs. Distrib. Servicemen Export Write Qty Prices!

NEW SILICON 500MA 100°C/280VAC/400P. V. Rectifier Hmt Scale 2.2 @ \$2.50 for \$6.50, 40 for \$46, 100 for \$100.00. Order \$10 postpaid 48 states.

NEW "TEKSEL" SELENIUM FULL WAVE BRIDGE RECTIFIERS. ONE YEAR GTD!

CURR. 18VAC 36VAC 72VAC 144VAC CONT. 14VDC 28VDC 56VDC 118VDC
1AMP \$ 1.30 \$ 2.00 \$ 4.00 \$ 9.45
2AMP 2.15 3.00 6.25 12.30
3AMP 2.90 4.00 8.50 16.75
6AMP 4.15 8.00 18.75 36.15
10AMP 6.10 12.15 26.30 48.90
15AMP 9.50 19.00 40.00 86.60
24AMP 15.00 29.45 57.50 108.45
Write for Rectifier & Transformer Catalog.

INFRARED RECEIVER ASSEMBLY USN/US SM-R1400. DIRECT VIEWING TELESCOPE. CHANGES INVISIBLE INFRARED ENERGY INTO A VISIBLE IMAGE ON AN INHIBIT SCREEN INCLUDES INFRARED FILTER, RADIOACTIVE SYSTEM. NAVY COST \$216 INCLUDES INST. CASE & DATA. SPECIAL \$21.

"TAB"—THAT'S A BUY—BARGAINS!

BC698/3 to 4 mc's good condition. \$4.98
AN-ARR2/RCV as is/good parts. \$1.89
RF-MTR GE/375 Ma & 5 Amp. \$5 @ 2/\$9
300 METER Weston 120 Ma. \$12 @ 2/\$22
DC-METER Dejur 800 Ma/3 1/2". \$4 @ 2/\$6
Relay 4PDT/3 Acts/12 to 24 VDC. \$1 @ 6/\$5
Silm Jim Dynamic Mike Hand or Std. \$3.98
Neck Mike Carbon New. \$98
90 Mc's/IF-Strip \$5; 30 Mc's/As is. \$3.00
86A 1/2 Combo & Fil XEMR/7.5KV Ins. \$5.98
Xmitting Mic's-.006 @ 2500V. \$5 for \$10.00

NEW TPSK2 DC POWER FOR TRANSISTORS!

Transistors! Filtered Power Supply Kit used to power transistor circuits, amplifiers etc. Delivers 12VDC at 2AMPS filtered less than 0.5% ripple or 28VDC at 1A TPSK2 Kit \$18. TPS2W assembled & wired \$24. RTV-METER Infr. Trans. Full Wave Bridge Rectifier for 12VDC @ 2AMPS. or RECTRAN KIT RT1K. \$4.50
RTV-METER Assembled & Wired. \$8.50
RT2K Kit 12 or 18VDC at 6 AMPS. \$9.00
RT2V Assembled & Wired. \$14.75
Battery charger kit 1 to 4 amps charges 2-4-6 & 12 volt batteries. \$9.95

HAMS NEW TRANSISTORIZED "TABPAK"

D.C. to D.C. Power Supply!!! Kit or assembled. Filtered. Small in Quartz Light Wgt. Inp. 12 to 14VDC. (Low Idle Current.) Output 450 & tap @ 250 VDC at up to 150 ma/65 watts. "TABPAK" Assembled TR39CB. \$35 "TABPAK" Kit TR39CK. \$30

"TAB" TERMS: Money Back Guarantee! Our 1st year. 24 hr. min. order. F.O.B. N.Y.C. Add shpg charges or for C.O.D. 25% Dep. Prices shown. Write for Catalog

111VG LIBERTY ST., N. Y. 6, N. Y. PHONE: RECTOR 2-6245

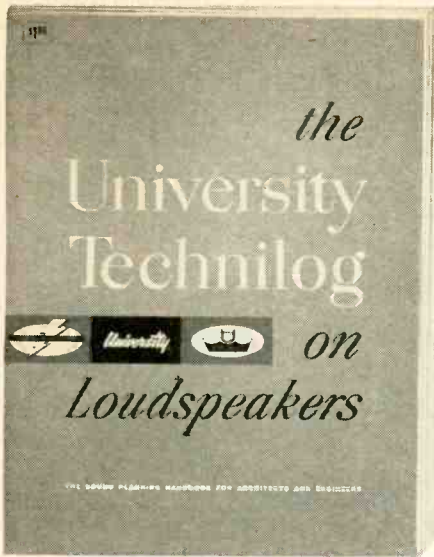

INVALUABLE NEW 64-PAGE

PRACTICAL SOUND PLANNING HANDBOOK

COMPLETE, AUTHORITATIVE... ONLY \$1

Over twice the size and far more comprehensive than the previous edition... and still the only book of its kind. Eleven fully illustrated chapters... each packed with solid, factual data... new techniques, new technical charts and diagrams, new products, and the exclusive Sound System Design Chart. An absolute *must* for engineers, technicians, architects and servicemen!

JUST A FEW OF THE SUBJECTS COVERED:

- How to judge and select drivers
- Mismatch and power transfer
- Wide-angle vs. directional horns
- Overload protection
- Correct phasing
- Control of reverberation
- Speakers as high output microphones
- Handling line matching transformers

... and much more... all representing the more than two decades of research and progress in the design and manufacture of loudspeakers which have made the University brand world famous. Yours for just one dollar.

MAIL THIS COUPON TODAY

Desk J-5, University Loudspeakers, Inc.
80 So. Kensico Ave., White Plains, N. Y.

I am enclosing \$_____ Please send me _____ copies of the all-new 64-page University Technilog.
 I would also like a free copy of your latest Product Catalog.

NAME _____

ADDRESS _____

CITY _____ ZONE _____ STATE _____

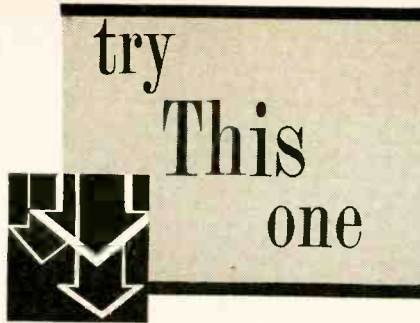

HOLSTER THAT GUN

That old familiar saying "There's a place for everything and everything should be in its place" is truly heeded in our service shop. Instead of allowing our soldering guns to remain cluttered up in a tangled mess when not in use, we keep them in toy-gun holsters tacked to either end of the bench. They are always ready for a fast draw when one of our hands brings a tough doggie to the shop for repairs.—*Tex's TV Service Shop*

RECORDER MIKE STAND

The tape recording enthusiast who has no stand-mounted mike can easily mount his hand-held mike on a base removed from a discarded electric desk fan. I mounted mine as shown in the photo, by making a loop from TV ribbon line, punching a hole near either end, and fastening the loop to the fan

base with a machine screw and washers. (You have to space the holes in the loop and determine its length for a snug fit by wrapping the lead around the contour of your individual mike.)

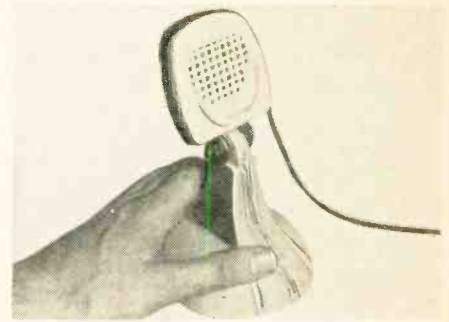

Once I had the lead fastened in place on the base, all I had to do was force fit my mike into the loop's opening. Using the base as a stand, I can quickly mount or dismount the mike and angle it up or down for good sound pickup.—*John A. Comstock*

LIFE SAVER

To prevent possible electrocution of customers owning ac-dc sets, we place strips of tape over the heads of the mounting screws before allowing any of these receivers to leave the shop. Customers have often commented favorably on this free extra service. Safeguards the technician's income on customers paying on the time plan too!—*Scott Mock*

SUBSTITUTE PARTS WITH-OUT SOLDERING

Quickly with E-Z-Hook "SUB" Connectors Easily Has 1001 Uses!

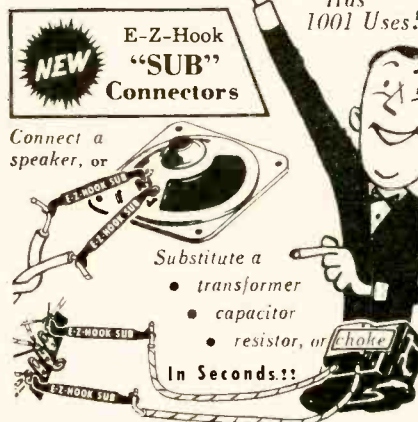

- ★ Makes connections instantly!
 - ★ Won't pull off!
 - ★ Insures positive contact!
- Saves time, money and parts in servicing, experimenting, instructing and production.

E-Z-HOOK SUB

No. 71-1...SUB... Only 69¢ ea.

Six Colors!—for Easy Lead Identification
ORDER THROUGH YOUR PARTS DISTRIBUTOR



E-Z-HOOK TEST PRODUCTS
Dept. G-3, 1536 Woodburn Ave.
Covington, Ky.

Canadian Rep: Len Finkler & Co., Toronto, Ont.

STAMP OF APPROVAL!



Only Known Merit marks a product as the "BEST"

for quieting Noisy Controls and Switches QUIETROLE produces results superior to any other product. That's why it's known as the "Best" and that's why more users prefer it to any other. It's the dependable Original product of its kind... a first in the Industry.

QUIETROLE Spray-Pack



In 2-oz. bottle with dropper and 6-oz. QUIETROLE SPRAY-PACK

or the QUIETROLE Bottle with the Eye Dropper Cap
QUIETROLE offers you both types of containers. Either way assures you of the same un-failing results that QUIETROLE is known for.

The Lubricant Cleaner of the Electronic World. Tailored for the industry by over 15 years of authentic research, plus 4 years of rigid and exacting tests before marketing.

Ask for QUIETROLE and be sure you get it!

manufactured by
QUIETROLE COMPANY
Spartanburg, South Carolina
Export Representative:
Riise International Corp.,
204 E. 28th St., New York 16, N.Y.

TRY THIS ONE (Continued)

SPAGHETTI FOR MINIATURE CIRCUITS

In miniature circuit construction the experimenter uses component leads to a greater extent than in conventional-size construction projects. Transistor leads usually are soldered directly to other components in the circuit.

Leads of miniature components and transistors are smaller than those on more conventional-size parts and, if the

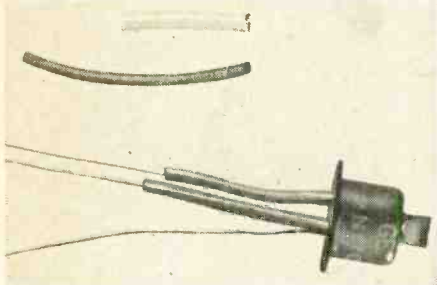

builder uses standard spaghetti for insulation, the leads become hard to work with.

I've found the plastic insulation I strip off No. 22 hookup wire is ideal for insulating spaghetti in miniature circuit work. Now I save the insulation I strip off hookup wire for use as spaghetti in miniature circuits. This spaghetti is flexible and small enough to do credit to miniature circuits.—*Forest H. Frantz, Jr.*

USE AN ATOMIZER

One of our most useful shop tools is an old-fashioned throat atomizer. We keep one filled with contact cleaner on the shelf and, whenever a set comes in with dirty controls or switch contacts, it's put to work.

It's especially helpful when we encounter an erratic RCA tuner. Rather than disconnect and dismantle the whole front end, we spray a mist of cleaner through the vent holes and have a like-new tuner in 10 seconds. Of course, this will also work on other sets using switch tuners.—*Frank Salerno*

SOLDERING TIP FOR PRINTED CIRCUITS

For fine, hard-to-reach work or the repair of printed circuits, use a soldering-gun tip modified as in the diagram.

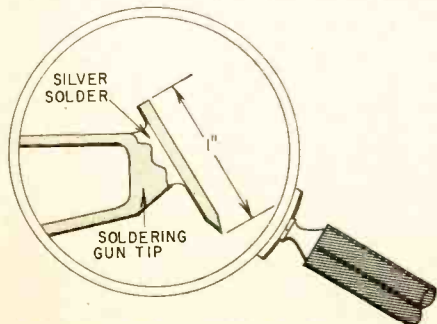

A 1-inch extension made from the shank of an old tip is silver-soldered to a standard tip. When working where a fine tip is needed, just slip the modified tip into the iron.—*S. Clark*

When Converting Your Phono to Stereo... Use

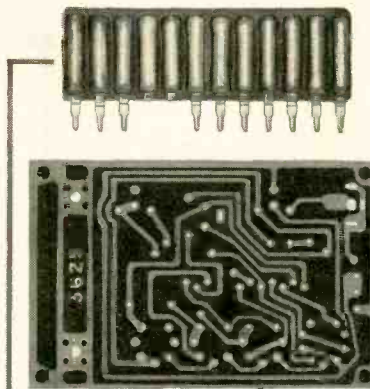

MODEL
PAC-AMP-1

See and hear it at
your local distributor
or *Write* for
nearest source.

The ERIE AUDIO-AMPLIFIER KIT featuring "PAC" and an ERIE Printed Wiring Board

With these Plug-in Components:

- ERIE "PAC" (Pre-Assembled Components)
- ERIE PRINTED BOARD
- OUTPUT TRANSFORMER
- FILTER CAPACITOR
- VOLUME CONTROL and SWITCH
- TUBE SOCKETS
- CAPACITORS
- TONE CONTROL
- TUBES

SPECIFICATIONS FOR ERIE STANDARD AUDIO-AMPLIFIER

- Frequency Response: 30 cycles to 12,000 cycles +0, -3.5 db.
- Sensitivity: 0.56 volt RMS (input at 1 KC) for 2 watt output.
- Power Output: 2 watts • Input Impedance: 2 megohms.
- Output Impedance: 4 ohms • AC Power Consumption: 17 watts.
- Overall Dimensions: 6 1/2" L x 4 1/8" W x 3 3/8" H • Shipping Weight: 2 lbs.

ERIE Electronics Distributor
DIVISION
ERIE RESISTOR CORPORATION
ERIE, PA.

ERSIN
Five Core
SOLDER
CONTAINS 5 CORES OF
NON-CORROSIVE FLUX

World's finest!

Made especially for the
RADIO AND ELECTRONIC MARKET

Guarantees your work —
FASTER! SURER! NO CALL-BACKS!

**LOWEST POSSIBLE PRICES —
PROMPT DELIVERY**

**SOLD ONLY THROUGH
RADIO PARTS DISTRIBUTORS!**



Dept. MM 388
MULTICORE SALES CORPORATION
PORT WASHINGTON, NEW YORK

NEW! IMPROVED!

SENCORE
TRC4
**TRANSISTOR
CHECKER**

Another Sencore Time-Saver

America's newest, most popular test instruments

NOW CHECKS:

- ★ **Transistors** for opens, shorts, leakage and current gain. Includes new gain test on power transistors.
- ★ **Crystal Diodes** checks forward to reverse current ratio on all diodes.
- ★ **Selenium Rectifiers** checks forward and reverse currents.

Controls are accurately set for each transistor by referring to replaceable set-up chart on rear. Test leads or socket provides for fast hook-up. See your parts distributor.

SIMPLE TO OPERATE
ONLY \$17.95
Dealer Net
Cannot become obsolete. Approved by leading manufacturers

Mfg by **SENCORE**
INSTRUMENTS CORP.
171 OFFICIAL RD., ADDISON, ILL.

Cut out this ad now for further information

Examine FREE



**Prentice-Hall
ELECTRONICS &
UHF LIBRARY**

Edited by
W. L. EVERITT

5 VOLUMES 1662 ILLUSTRATIONS
Pay Easy Installments If You Keep the Set

Turn to this new, up-to-date Library with complete confidence, for dependable facts on any phase of modern electronic theory and practice. These volumes, by outstanding authorities, give you thorough guidance—clearly written, logically arranged, profusely illustrated.

Electronic Fundamentals and Applications

By Prof. John D. Ryder.
Dean, College of Engineering, Michigan State University
Complete, logical, easy-to-follow treatment of (a) physical principles underlying electron tubes, (b) characteristics of vacuum tubes, (c) all basic tube circuits. Includes: Electron Ballistics, Cathode-Ray Tubes, Emission of Electrons, Space Charge in Vacuum Tubes, Diode Rectifiers, Triodes, Multi-Element Tubes, Small-Signal Amplifier Circuits, Audio-Frequency Amplifiers, Radio-Frequency Amplifiers, Oscillator Circuits, Modulation Systems, Wave-Shaping Circuits, Gaseous Conduction, Gas Diodes, Gas Control Tubes, and Circuits, Photoelectric Cells, Solid-State Electronics.

Electromagnetic Waves and Radiating Systems

By Prof. Edward C. Jordan.
Head, Dept. Electrical Engineering, Univ. of Illinois
Covers entire field of electromagnetic engineering. Includes propagation as well as radiation and transmission. Full treatment of UHF transmission lines, wave guides, antennas, slot antennas, radiation and diffraction, ground-wave and sky-wave propagation.

Ultra High Frequency Engineering

By Thomas L. Martin
Head, Dept. of Electrical Engineering, Univ. of Arizona
Theory and technique of ALL the new fields of electronic engineering: Radar, Telemetering, Electronic computing, Facsimile, Television, Blind landing systems, Pulse-time modulation, Ionosphere measurements . . . and the others.

Networks, Lines and Fields

By Prof. John D. Ryder.
Dean, College of Engineering, Michigan State University
Network transformations and theorems. Resonance. Impedance transformation and coupled circuits. Filters. General transmission line, High-frequency line. Equations of the electromagnetic field, Radiation, Transmission and reflection of plane waves at boundaries. Guided waves between parallel planes. Wave guides.

Elements of Television Systems

By George E. Anner, University of Illinois
Complete basic theory, plus current practice, covering: Closed TV systems, Commercial Telecasting Systems, Color TV Systems. Gives clear exposition of all phases of picture transmission, including the new technique of dot interlace.

SEND NO MONEY—EXAMINE FREE

Just mail coupon below to get complete 5-Volume Set on 10 DAYS' FREE TRIAL. If not completely satisfactory, return in ten days and owe nothing. Or keep the set and pay only \$7.50 down and \$8 a month for five months until full price of \$47.50 is paid. Decide for yourself—without risk or obligation—just mail coupon to examine Library ten days free.

Prentice-Hall, Inc., Dept. 5744-L1
Englewood Cliffs, N.J.

Send me the Prentice-Hall ELECTRONICS & UHF LIBRARY (5 Volumes) for ten days' free examination. If fully satisfied in ten days I will send you \$7.50 plus few cents postage and then \$8 a month for five months until full price of \$47.50 is paid. Or I will return the Library in ten days and owe nothing.

Name.....

Address.....

City and State.....

TRY THIS ONE (Continued)

**GROMMET PROTECTS
TRANSISTORS**

To protect a transistor from blows that are likely to injure it internally, I slip a rubber grommet over the tran-



sistor's case. The grommet makes a protective bumper that wards off damaging blows. Grommets are available that will fit almost every round or oval transistor.—John A. Comstock

**CONNECTIONS WITH
ALLIGATOR CLIPS**

The versatile twin clip shown in the photo lets you make quick and easy connections to an alligator clip in experimental work. Such parts as wire leads, fixed capacitors, fixed resistors, variable resistors, germanium diodes, phone tips, banana plugs, etc. may be connected to the piggyback clip, and then the main clip may be used in the normal way.
To make this twin clip, simply force

the lug end of a Mueller No. 30 clip into the sleeve of a Mueller 60 clip, and then mash the sleeve with a pair of pliers. A bit of solder helps make a solid joint.

If you want to use the larger 60 clips on both ends, simply squeeze one sleeve

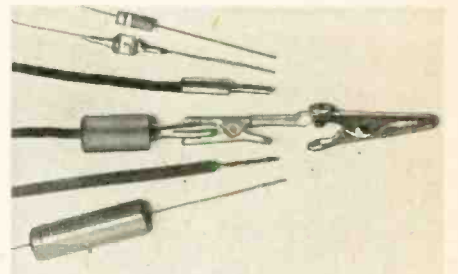

to a smaller diameter and force it into the other sleeve. Then run a little solder over the joint.—Art Trauffer

INSULATING RF CHOKES

An rf choke with exposed metal ends can be insulated against accidental contact with a chassis ground or other components by spray-insulating its ends with anti-corona dope.

Do not spray the piewound sections any more than absolutely necessary, for too much dope may increase the choke's distributed capacitance, lowering its effectiveness in the circuit.—J. C. Alexander
END

MAKE OVER 150 SMALL COMPUTING AND REASONING MACHINES WITH

BRAINIAC®

A BETTER ELECTRIC BRAIN CONSTRUCTION KIT

Only \$17.95 . . .
Why Pay More?



EQUALS THE ORIGINAL GENIAC® electric brain construction kit (1955) PLUS many improvements and additions—over 600 parts including 116 patented wipers so that all switches work well. Instead of covering only 33 machines, BRAINIAC gives full specifications for 151 computing, reasoning, arithmetical, logical, puzzle-solving and game-playing machines. GENIAC ACS (1955) and 118 BRAINIACS (1956-58). Each machine works on a single flashlight battery—all connections with nuts and bolts—no soldering required. It's FUN to make—FUN to use and play with—and TEACHES you something new about computing and reasoning circuitry.

ORIGINATED AND PRODUCED EXCLUSIVELY by Berkeley Enterprises, BRAINIAC is the result of 8 years' design and development work with miniature mechanical brains including: Geniac (see "Geniacs: Small Electric Brain Machines and How to Make Them" by E. C. Berkeley, 64 pp., published 1955 by Geniac Project, a partnership with Oliver Garfield discontinued September 1955); Relay Moe (automatic machine playing tic-tat-toe pictured in Life Magazine, March 1950); etc. Berkeley is Author of "Giant Brains or Machines that Think" (Wiley, 1949), and other books & papers; Editor of the magazine "Computers and Automation"; Designer of all the Brainiacs and more than half of the 35 Geniacs (1955); etc.

WHAT CAN YOU MAKE WITH BRAINIAC KIT K 17? LOGIC MACHINES: Syllogism Prover, Intelligence Test, Boolean Algebra Circuits, etc. GAME-PLAYING MACHINES: Tic-Tat-Toe, Nim, Black Match, Whoped Bandit, etc. COMPUTERS: To add, subtract, divide, multiply using decimal or binary numbers; Forty Year Calendar, etc. CHRONOLOGICAL MACHINES: Chronological Converter, Lock with 15,000,000 Combinations, etc. PUZZLE-SOLVING MACHINES: The Missionaries and the Cannibals, Submarine Rescue Chamber, The U-Boat, Rocket Ship and the Space Plator, etc. QUIZ MACHINES: History, geography, mathematics, etc. . . . AND MANY MORE!

WHAT COMES WITH YOUR BRAINIAC KIT? Complete descriptions of 151 experiments • Manual of explanation/instruction by E. C. Berkeley • Over 600 pieces including control panel, multiple switch discs, jumpers, improved wipers, bulbs, sockets, wire, etc. • Over 160 circuit diagrams including 46 exact wiring templates • "How to Go from Brainiacs and Geniacs to Automatic Computers" by E. C. Berkeley • Claude Shannon's historic 1938 paper "A Symbolic Analysis of Relay & Switching Circuits" • List of references to computer literature • Etc.

BRAINIAC KIT (1958 Model K 17) the kit with limitless possibilities backed by an organization of 10 years' standing in the computer field. . . . \$17.95 (For shipment west of Mississippi, add 80c; outside USA, add \$1.80)

7-DAY FULL REFUND GUARANTEE IF NOT SATISFACTORY

---MAIL THIS COUPON---
BERKELEY ENTERPRISES, Inc.,
815 Washington St., R156, Newtonville 60, Mass.
Please send me Brainiac Kit K 17. (Returnable in 7 days for full refund if not satisfactory—*if in good condition.) I enclose \$..... in full payment.
My Name and Address are attached.

2 WAY PORTABLE RADIO SET

Sends—Receives up to 10 miles as shown or hundreds of miles with outside antenna 80 and 40 meter amateur radio bands (novice) also Aircraft and overseas broadcasts (3 to 8 mc.). POWERED WITH SELF-CONTAINED PORTABLE RADIO BATTERIES. NO AC PLUG-INS NEEDED! Take it with you everywhere you go—Keep in contact with home, friends. Has 5 watt crystal controlled transmitter—Sensitive, Regenerative Receiver, Send-receive switch. Wt. only 3 lbs. Size, only 6"x4"x4". TESTED—PROVEN—SIMPLIFIED—PRACTICAL—Full information given on quick easy to get license.
SEND ONLY \$3.00 (bill, ck. mo) man \$12.95 COD postage on arrival or send \$15.95 for postpaid delivery. Complete kit includes all parts, tubes, coils, plastoid cabinet, easy instructions. (Set of batteries—\$3.49; crystal \$1.49). COMPLETELY WIRED AND TESTED POSTPAID \$19.95. A regular \$49.95 value—Order now before price goes up.
GUARANTEED—AVAILABLE ONLY FROM:
WESTERN RADIO Dept. 8N R-9 KEARNEY, NEBR.

MAIL ORDER HI-FI

You can now purchase all your Hi-Fi from one reliable source and be assured of perfect delivery. Carston makes delivery from NY stock on most Hi-Fi, Recorders and Tape within 24 hours. SEND US A LIST OF YOUR HI-FI REQUIREMENTS FOR OUR QUOTATION.
CARSTON STUDIOS 215-RD E. 88 St. New York 28, N. Y.

LOOK
no further . . . if you're searching for hi-fi savings. Write us your requirements now.
Key Electronics Company
120-A Liberty St., N.Y. 6, N.Y.
EV 4-6071

**BOOK MANUSCRIPTS
CONSIDERED**
by cooperative publisher who offers authors early publication, higher royalty, national distribution, and beautifully designed books. All subjects welcomed. Write, or send your MS directly.
GREENWICH BOOK PUBLISHERS, INC.
Attn. MR. JMMS 489 FIFTH AVE.
NEW YORK 17, N. Y.

Business and People

Jensen Industries, Forest Park, Ill., is promoting its new line of phonograph cartridges with a display card which



will accommodate six of the most popular types in transparent plastic cases. A screw-holding screwdriver is offered the purchaser of each cartridge.

JFD Electronics Corp., Brooklyn, N. Y., was awarded a mechanical patent

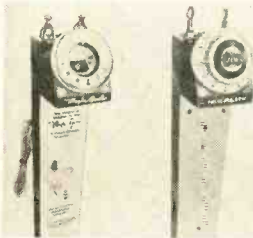

and design patent for its Magic Genie and Merlin indoor TV antennas.

National Schools, Los Angeles, is exhibiting a full-scale model of the Explorer I, the United States' first satel-



lite. E. Witke (left), National Schools instructor, is shown pointing out the instrument package included in the exhibit.



Amperex Electronics Corp., Hicksville, N. Y., is importing and distributing Valvo tubes which are used extensively in German-made radios and hi-fi equipment. The replacement tubes will be



NOW 2 ASSEMBLE-IT-YOURSELF **SAVE HALF NO SPECIAL SKILLS PAY KIT-BY-KIT**

Schober ELECTRONIC ORGANS

Now you can afford an electronic organ. Whether you choose the full Concert model or the smaller Console, you have an organ equal to any made by the foremost manufacturers. In addition, you save over 1/2 the cost because you assemble it yourself...and you enjoy the thrill of achievement. Too, you purchase each kit only when you are ready for it.

	<p>2 different MODELS 2 different SIZES 2 different PRICES</p>	
<p>CONCERT MODEL</p> <ul style="list-style-type: none"> ☆ TWO FULL SIZE PIPE-ORGAN MANUALS, 122 KEYS ☆ OCCUPIES 3'5" x 4'7" FLOOR SPACE ☆ 26 STOPS AND COUPLERS ☆ 32 BASS PEDALS ☆ ASSEMBLED CONSOLE ☆ CONFORMS TO AMERICAN GUILD OF ORGANISTS SPECIFICATIONS FOR PIPE ORGANS ☆ COMPLETE STEP-BY-STEP INSTRUCTIONS 	<p>CONSOLETTA MODEL</p> <ul style="list-style-type: none"> ☆ OCCUPIES ONLY 2' x 3'2" FLOOR SPACE ☆ TWO FULL SIZE PIPE-ORGAN MANUALS, 122 KEYS ☆ 22 STOPS — ABOVE-KEYBOARD TABS ☆ 13 HEEL-AND-TOE BASS PEDALS ☆ 7 FULL OCTAVES OF TONE (DOWN TO 32 CPS) ☆ BUILT-IN SPEAKERS OPTIONAL ☆ ASSEMBLED CONSOLE ☆ COMPLETE STEP-BY-STEP INSTRUCTIONS 	

10" LP RECORD DEMONSTRATING BOTH MODELS AVAILABLE FOR \$2, REFUNDABLE UPON PURCHASE

FREE NEW 1959 EDITION OF 16 PAGE ILLUSTRATED BOOKLET ON REQUEST

Write Now — See What Fine Instruments You Get At Such Great Savings

The **SCHOBBER ORGAN** Corporation • 2248-B BROADWAY • NEW YORK 24, N.Y.

SCHOBBER KITS ALL OVER THE WORLD

☆ Designed by Richard H. Dorf.



COYNE
TRAINS YOU
IN SPARE TIME
AT HOME

TELEVISION

RADIO - COLOR TV

Only from famous COYNE do you get this modern up-to-the minute TV Home Training. Easy to follow instructions—fully illustrated with 2150 photos and diagrams. Not an old Radio Course with Television tacked on. Includes UHF and COLOR TV. Personal guidance by Coyne Staff. *Practical Job Guides* to help you EARN MONEY QUICKLY IN A TV-RADIO SALES AND SERVICE BUSINESS—part time or full time. COSTS MUCH LESS—pay only for training—no costly "put together kits."

SEND COUPON FOR FREE BOOK

SEND COUPON BELOW for Free Book and full details including EASY PAYMENT PLAN. NO COST OR OBLIGATION—NO SALESMAN WILL CALL.



B. W. COOKE, Jr., Pres. **COYNE ELECTRICAL SCHOOL** FOUNDED 1899

TECHNICAL TRADE INSTITUTE OPERATED NOT FOR PROFIT
500 S. Paulina, Dept. 68-H5, Chicago 12, Illinois

COYNE ELECTRICAL SCHOOL
Television Home Training Div.
500 S. Paulina St., Chicago 12, Ill., Dept. 68-H5

Send FREE BOOK and details of your Television Home Training offer.

Name _____
Address _____
City _____ State _____

NEVER BEFORE

ANY NUMBER OF TV OUTLETS FROM A SINGLE ANTENNA

* Switchmatic

TELEVISION RECEPTACLES

Here's How It Works

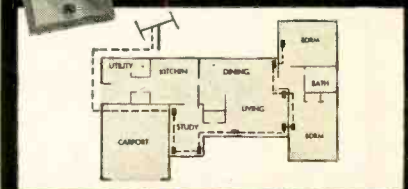

Plug TV into any outlet and the Switchmatic Receptacle automatically switches the antenna to that outlet.

AT PARTS JOBBERS EVERYWHERE

Write for Bulletin #W-46

* Another Serviceman Designed Product

MANUFACTURED BY
R-COLUMBIA PRODUCTS CO., Inc.
Highwood, Illinois

COMPLETE TRAINING FOR BETTER RADIO-TV SERVICE JOBS



Let these two world-famous Ghirardi training books teach you to handle all types of AM, FM and TV service jobs by approved professional methods—and watch your efficiency and earnings soar!

Completely modern, profusely illustrated and written so you can easily understand every word, these books pave the way to fast, accurate service on any type of home radio-TV-electronic equipment ever made. Each book contains the latest data on the latest methods and equipment—NOT a rehash of old, out-of-date material. Each is co-authored by A. A. Ghirardi, whose famous RADIO PHYSICS COURSE and MODELIN RADIO SERVICE were, for 20 years, more widely used for military, school and home study training than any other books of their type!

THE NEW Ghirardi

RADIO-TV SERVICE LIBRARY

Almost 1500 pages and over 800 clear illustrations show step-by-step how to handle every phase of modern trouble-shooting and servicing.

1—Radio and Television Receiver TROUBLESHOOTING & REPAIR

A complete guide to profitable professional methods. For the novice, it is a comprehensive training course. For the experienced serviceman, it is a quick way to "brush up" on specific jobs, to develop improved techniques or to find fast answers to puzzling service problems. Includes invaluable "step-by-step" service charts. 820 pages, 417 illus., price \$7.50 separately. See combination offer!

2—Radio and Television Receiver CIRCUITRY AND OPERATION

This 609-page volume is the ideal guide for servicemen who realize it pays to know what really makes modern radio-TV receivers "tick" and why. Gives a complete understanding of basic circuits and circuit variations; how to recognize them at a glance; how to eliminate guesswork and useless testing in servicing them. 417 illus., price separately \$6.75.

New low price . . . You Save \$1.25!

If broken into lesson form and sent to you as a "course," you'd receive these two great books at a bargain at \$50 or more! Together, they form a complete modern servicing library to help you work faster, more efficiently and more profitably.

Under this offer you buy them both for only \$13.00. You save \$1.25 on the price of the two books—and have the privilege of paying in easy installments while you use them.

10-DAY FREE TRIAL

Dept. RE-98, RINEHART & CO., Inc.
232 Madison Ave., New York 16, N.Y.

Send book(s) below for 10-day FREE EXAMINATION. In 10 days, I will either remit price indicated (plus postage) or return books postpaid and owe you nothing.

Radio & TV Receiver TROUBLESHOOTING & REPAIR, (Price \$7.50 separately)

Radio & TV Receiver CIRCUITRY & OPERATION (Price \$6.75 separately)

Check here for MONEY-SAVING COMBINATION OFFER . . . Save \$1.25.

Send both of above big books at special price of only \$13.00 for the two (regular price \$14.25) . . . you save \$1.25. Payable at rate of \$4 (plus postage) after 10 days if you decide to keep books and \$3 a month thereafter until \$13 has been paid.

Name.....

Address.....

City, Zone, State.....

Outside U.S.A.—\$8 for TROUBLESHOOTING & REPAIR; \$7.25 for CIRCUITRY & OPERATION; \$14 for both. Cash with order only, but same 10 day return privilege.

BUSINESS AND PEOPLE (Continued)

sold through regular Amperex distributors.

Thorens Co., New Hyde Park, N. Y., importers of Swiss-made hi-fi products, announced the winner of its recent contest for the best description of an ideal hi-fi salesman. Prize is the choice of



any one Thorens hi-fi product every year for the next 10 years. In the photo, James Carroll (left), Harvey Radio, described as the ideal hi-fi salesman, receives a check of recognition from Paul W. Kind (right) of Thorens. Hannes Beckmann, the contest winner, looks on.

The EIA reported the sale of 14,894,230 transistors for the first five months of 1958 compared to 8,954,000 for the January-May period in 1957. The institute expanded its statistical service, effective July, with the collection of monthly factory-production figures on FM receivers. It estimates that there are now 11.8 million FM receivers in use in the US.

Reed Vail Bonteou joined CBS-Hytron, Danvers, Mass., as vice president—marketing, of the CBS Electron Tube and Semiconductor Div. He comes to CBS-Hytron from General Electric where he was manager of marketing for the Receiving Tube Dept.



Leslie M. Cassidy is now director of Daystrom, Inc., Murray Hill, N. J. He was formerly president and chairman of Johns - Manville where he has been serving as a director and consultant since last year.



Dr. Alfred K. Wright, vice president in charge of engineering for Tung-Sol Electric, Inc., Newark, N. J., was given additional responsibilities as vice president in charge of Operations and En-

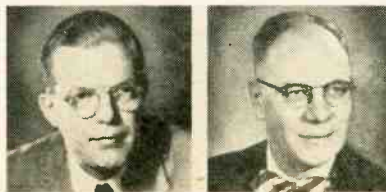

gineering. Paul Scharninghausen, (right) general manager—electron-tube manufacturing, was advanced to vice president and general manager of the Radio and Television Tube Div. Centralab Division of Globe-Union,

Positive Indication SELENIUM and SILICON IN-CIRCUIT TESTER

New!

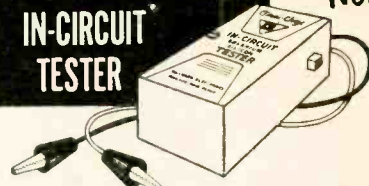

HALLMARK Omni-Chex

... starts where V.O.M.'s stop

- Checks transistors, diodes, vibrators.
- Detects inferior rectifiers weeks before they cause trouble in sets.
- Cuts down callbacks—helps rectifier sales.

ONLY \$5.95

Available at your distributor



HALLMARK ELECTRONICS CORP.
436 N. 31st Street
Philadelphia 4, Pennsylvania

CATHODE RAY TUBE SPECIALS ONE YEAR GUARANTEE

Type	STAN BURN	Type	STAN BURN	Type	STAN BURN
10BP4	\$10.00	16LP4A	16.25	21EP4B*	23.25
12LP4A	13.95	17BP4	15.75	21FP4	21.15
12OP4	11.50	17BP4B*	18.75	21MP1	26.25
12UP4	15.00	17CP4	20.50	21VP1	22.00
14CP4	13.75	17EP4	21.50	21VP4A*	25.00
15DP4	14.50	17LP4	18.00	21ZP4	21.00
16AP4	18.50	19AP4A	24.00	21ZP4B*	24.00
16DP4A	15.25	20CP4A	18.95	24AP4	56.00
16EP4	18.75	20CP4B*	21.95		(6 mos. guar.)
16KP4	15.75	21AP4	25.00	24CP4A*	38.00
16KP4A*	18.75	21EP4A	20.15	24DP4A*	39.00

*Aluminized Stan-Burn CRT tubes RCA Licensed, mfd. by Lincoln. FOB New York warehouse.

HI-FI DIAMOND NEEDLES—1 Yr. Guar.
SINGLE DIAMOND needle.....\$4.95
DIAMOND SAPP dual needle.....5.95
(plus 25c postage—Specify cartridge make)

\$20 WORTH OF ELECTRONIC PARTS IN GRAB-BAG consisting of: Porcelain sockets, coils, speaker transf. resis. cond. ONLY \$1.98 (plus 50c postage)

COLLARO TC 340 RECORD CHANGER with 500-TONE DIAMOND-SAPP. STEREO cart. \$34.95.

NOBODY BUT NOBODY BEATS OUR HI-FI PRICES! Send us your requirements for STAN-BURN'S LOWEST QUOTATIONS on systems, kits, and individual components.

STAN-BURN RADIO and ELECTRONICS CO.
558 CONEY ISLAND AVE. • B'KLYN 18, N. Y.

BUILD YOUR OWN COMPUTER

FANTASTIC? NOT ANY LONGER!



EBEX School courses will not only teach you how to build computers of all types, but also how to design them. 50 computer courses and kits.

EBEX, Inc.

1015 Atkin Ave. SLC 6, Utah

- Send book of opportunities in computers
- Send free catalog on courses
- Send free catalog on kits

Attach Name and Address



Milwaukee, Wis., presented cash awards to the three winning rep organizations in its capacitor-kit sales contest. In the photo, left to right, Gerry Mills, Centralab distributor sales manager, presents checks to Ted Lowell, Gordon LeRoy and John McGuire (of LeRoy & McGuire), and Les Logan.

Arthur F. R. Cotton, British electronics engineer, joined Capitol Radio Engineering Institute, Washington, D. C., as director of European operations. He has set up overseas headquarters in London.



Electro-Voice, Inc., Buchanan, Mich., named William R. Lanphear, Seattle, as its sales representative of the year.



H. H. Scott Inc., Maynard, Mass., announced the winners of its 1957-58 sales awards at its annual sales meeting. Jack Fields Sales Co. rang in the best overall sales performance. Rod Butchart Co. showed the greatest gain in territorial sales volume, and F. W.



Moulthrop Co. notched the outstanding sales achievement award. Jack Fields and Jack Simon are shown receiving plaque from Herman Hosmer Scott.

John Q. Adams, vice president-sales, of CBS-Hytron, Danvers, Mass., retired after 15 years with the company and 36 years in the industry.

Harry J. Veitch, formerly with Oak Manufacturing Co., joined Phaoston Instrument and Electronic Co., South Pasadena, Calif., as vice president in charge of sales. END

Answers to the quiz on page 95

- | | | |
|------|-------|-------|
| 1. K | 8. T | 15. Q |
| 2. G | 9. A | 16. D |
| 3. R | 10. H | 17. S |
| 4. N | 11. E | 18. O |
| 5. I | 12. M | 19. F |
| 6. P | 13. B | 20. L |
| 7. C | 14. J | |

DYNAKIT AMPLIFIER KITS

A great amplifier circuit of superb listening quality in money-saving kit form!



Available from leading Hi-Fi dealers everywhere
Descriptive brochure available on request.

**NEW! DYNAKIT
STEREO CONTROL KIT**
ADDS COMPLETE STEREO
CONTROL FUNCTIONS TO TWO
PREAMPLIFIERS FOR ONLY **\$12.95**

Data Sheet Available on Request

MARK III 60 Watts **79⁹⁵*** net

The new Mark III includes all the sensational attributes of the popular Mark II plus these outstanding deluxe features.

- ★ 60 watts at less than 1% distortion. Instantaneous peak power of 140 watts. 1M less than .05 at average listening levels.
- ★ Choke filtering and low noise circuitry reduce hum and noise to 96 db below 60 watts.
- ★ New rugged KT-88 tubes and other heavy duty parts used conservatively.

MARK II 60 Watts **69⁷⁵*** net

The Mark II is the best buy in high power high fidelity kits

- ★ Ease of assembly due to uniquely simple circuitry and printed circuit construction with factory-mounted parts.
- ★ Highest stability using patented stabilizing networks with minimum number of phase shifting stages. Suitable for all loud-speaker systems including electrostatic.
- ★ Dyna Biaset (patent pending) for simplified adjustment and complete freedom from effects of unbalanced components. No balancing adjustments required to meet published specifications.
- ★ Dynaco Super-Fidelity output transformer with patented para-coupled windings. This is the finest available transformer of its type for the most critical audio uses.

*Slightly higher in West

DYNACO INC. 617 No. 41st St., Phila. 4, Pa.

Export Division:
25 Warren St., New York 7, N. Y.



**self-service
tube testers offer a
lucrative BUSINESS
OPPORTUNITY for you**

Start a big income producing tube tester route without giving up your present job or business. If you ever planned some day of starting a solid growing business, this is the time to do so. Place Century's money-making self-service tube testers with tubes on consignment in drug stores, luncheonettes, super-markets and other retail outlets. Consumers test their own radio and TV tubes automatically 12 hours a day—7 days a week. Defective tubes are replaced on the spot for highly profitable sales. Each Century tube tester you place can net up to \$1000 a year . . . and there is no limit to how many you can handle spare or full time. No selling required . . . Century backs you up with a proven plan of operation, sales literature, window streamers, etc.

Learn how you can start to build a good business of your own in this unlimited market, without giving up your present source of revenue. Write today for FREE booklet that tells all about this booming business.

**MAIL THIS
COUPON
TODAY FOR
FREE
BOOKLET!**

CENTURY ELECTRONICS CO., INC.

Dept. E-9, 111 Roosevelt Avenue, Mineola, N. Y.

Please send me without obligation, FREE booklet and particulars about setting-up a self-service tube tester route. I understand no salesman will call.

Name Please print clearly

Address

City State

TRUE HI-FI for PUBLIC ADDRESS VOICE and MUSIC



WT-6 NET \$34.50

support stand only,
SS-4 NET \$12.60

new ATLAS COAX-PROJECTOR WT-6

for wherever HI-FI is a MUST, indoors or out . . . entertainment places: theatres, auditoria . . . industrial music & paging systems . . . outdoors: carnivals, pools, boat clubs . . . home patios, gardens . . . permanent or portable installations.

ALL-WEATHER

— install it, forget it! —

HIGH-EFFICIENCY . . . COMPACT . . .

True HIGH FIDELITY TWO-WAY system — not just a "compromise" of two horns coupled to a single diaphragm. The WT-6 comprises a weather-proof cone type driver (with 6-inch throat) coupled to its individual woofer horn; a separate pressure-type driver loaded to its separate tweeter horn. The built-in crossover electronic filter supplements the electro-mechanical frequency-limiting characteristics of the 2 individual reproducers — providing for smooth frequency division as each speaker functions within its engineered range of frequencies. Universally adjustable "U"-type rugged steel mounting . . . finished in high temperature baked modern beige enamel.

Power Rating	15 watts continuous
Freq. Resp.	140-15,000 cps
Impedance	8 ohms
Dispersion	120°
Dimensions	Bell opening 15", overall depth 12"

See the WT-6 at your local distributor.
Send for complete catalog R-9.



ATLAS SOUND CORP.

1449-39 St., Brooklyn 18, N. Y.
Atlas Radio Ltd., Toronto, Canada

technical Literature



Any or all of these catalogs, bulletins, or periodicals are available to you on request direct to the manufacturers, whose addresses are listed at the end of each item. Use your letter-head—do not use postcards. To facilitate identification, mention the issue and page of RADIO-ELECTRONICS on which the item appears. UNLESS OTHERWISE STATED, ALL ITEMS ARE GRATIS. ALL LITERATURE OFFERS ARE VOID AFTER SIX MONTHS.

COIL REPLACEMENT GUIDE for TV technicians, No. 159. This 72-page loose-leaf-punched book lists replacement coil numbers for virtually all TV chassis. Listed are picture and sound if transformers, adjustable ion traps, video peaking coils, antenna matching coils, linearity and width controls, horizontal oscillator and sync control coils.—J. W. Miller Co., 5917 S. Main St., Los Angeles 3, Calif.

"DON'T DO IT YOURSELF," advises a pocket-sized folder, designed for distribution by TV technicians. Containing reprints of cartoon advertisements originally printed in *TV Guide*, the folder *TV Service Safety Hints* dramatizes the dangers and pitfalls of amateur doctoring of TV ailments.—P. R. Mallory & Co. Inc., Distributor Div., 34 S. Gray St., Indianapolis 6, Inc. \$1 per 100.

FOR THE TECHNICIAN there's a little of everything in the 1959 edition of the *G-C catalog (No. 158)*. The 80-page book includes, as usual, cements and chemicals, tools and service aids, speaker kits, plugs and jacks, test leads, switches, components and hardware—**General Cement Mfg. Co.**, 400 S. Wyman St., Rockford, Ill.

WIRE AND CABLE, from mike cables to appliance cords, comprise 20-page *2-color Catalog No. 58*, which features *Parallead* lead-in the plus standard and custom-constructed wire and cable for virtually every electronic need.—**International Wire & Cable Co.**, 1665 N. Milwaukee Ave., Chicago, Ill.

SERVICING BOOKS using "comparison method" of troubleshooting are listed in 4-page circular.—**Supreme Publications**, 1760 Balsam Rd., Highland Park, Ill.

SMALL MOTORS of fractional horsepower, designed for phonographs, fans, tape recorders, advertising displays, antenna rotators, remote TV tuning and other uses are subject of loose-leaf catalog containing data sheets for each type of motor.—**General Industries Co.**, Elyria, Ohio.

JACKS AND PLUGS occupy most of the space in 12-page *Bulletin 558*, which also includes push-button switches,

This is the 2-Set TV COUPLER

Rated No. 1

• • • by a nationally known independent product quality rating group as the result of tests made on 10 leading two-set couplers for:

- IMPEDANCE MATCH
- SIGNAL TRANSFER
- TWO-SET ISOLATION

MOSLEY 902



List Price \$3.10

For U.S.A. Only

Rated **FIRST** in overall quality for weak signal reception means; the MOSLEY 902 Dual Match 2-Set TV Coupler can be sold and installed in practically any TV area with full confidence that your customers will be completely satisfied!

Available at Radio and Television Parts Distributors — coast-to-coast.

Mosley
Electronics, Inc.
8622 ST. CHARLES ROCK ROAD
ST. LOUIS 14, MISSOURI

INFRARED SNOOPERSCOPIES

SEE IN TOTAL DARKNESS... UNDETECTED!

FOR:
• Research
• Crime Detection
• Wildlife Study

Army Model M-2

Now available...complete Snooperscopes...PRICED \$50 TO \$85
LAMPS • OPTICS • TUBES • PARTS
Write today for FREE Infrared Catalog...
Contains amazing low prices of assembled units...individual parts. Also, detailed description and applications.
We have one of the world's largest stocks of Infrared parts and equipment.
McNEAL ELECTRIC & EQUIPMENT CO.
4736 Olive St., Dept. RE-9, St. Louis 8, Mo.

TECHNICAL LITERATURE (Continued)

stack assemblies, standard and miniature connectors and adapters for use in modifying connectors.—Richards Electrocraft Inc., 4432 N. Kedzie Ave., Chicago 25, Ill.

DECADE COUNTER TUBES, the second edition of a popular technical booklet, has 8 pages of information on the most popular cold-cathode counter tubes as well as discussion of theory of operation and circuit diagrams.—Sylvania Electric Products Inc., 1100 Main St., Buffalo, N. Y.

RESISTANCE DECADE BOXES are shown and described in *Catalog 20D*, which features nearly 150 types. The 8-page 2-color catalog offers units with from 2 to 5 dials and accuracy ranging from .05% to 1%.—Cinema Engineering Div., Aerovox Corp., 1100 Chestnut St., Burbank, Calif.

RELAY CATALOG, 16 pages, features hundreds of relays, steppers, solenoids, rectifiers and related components.—Universal Relay Corp., 42 White St., New York 13, N. Y.

PRECISION POTENTIOMETERS in standard designs are detailed in 8 data sheets and a brochure making up catalog of new single- and multi-turn units.—Electromath Corp., 42-14 Greenpoint Ave., Long Island City 4, N. Y.

MICROWAVE FILTER catalog: *C3-58* lists standard low-pass and high-pass filters of block, tubular and shell types operating from 10 to 12,000 mc; *Supplement 1 to Catalog C2* illustrates typical waveguide rf filters with very sharp cutoff and low insertion loss in passband.—Microphase Corp., Box 1166, Greenwich, Conn.

TRANSISTOR POWER SUPPLIES, *Q-Nobatron* line, are pictured and described in a product data sheet. Low-voltage, high-current supplies with outputs of 6, 12 or 28 volts at 15 or 30 watts.—Sorenson & Co. Inc., Richards Ave., South Norwalk, Conn.

ELECTRONIC INSTRUMENTS for measurement and analysis are grouped for easy reference into sections covering automatically scanning spectrum analyzers, special-purpose analysis instrumentation, accessory instruments and telemetering-system test equipment in 12-page 1958 catalog digest.—Panoramic Radio Products Inc., 514 S. Fulton Ave., Mount Vernon, N. Y.

CIRCULAR SLIDE RULE, pocket size, is useful for simple calculations involving multiplication, division and proportion. Complete with instructions.—General Industrial Co., 5738 N. Elston Ave., Chicago 30, Ill. 50c. Free to engineers and business executives.

SLEEVING AND TUBING *Catalog T-58* lists complete line of *Biraco*, *Birflon* and *Birflex* brands in 21 pages, including price and stock sheets and cross-reference chart giving physical and technical specifications.—Birnbach Radio Co. Inc., 145 Hudson St., New York 13, N. Y.

END

TELEVISION



**AT HEADS YOU LEARN
BY DOING IN MODERN
ELECTRONICS LABORATORIES**

HEALD ENGINEERING COLLEGE

Established 1863
Van Ness at Post, RE
San Francisco, Calif.

Never before in American history has the need been so great for Trained Engineers and Technicians. No other type of training can compare with actual shop practice you get at Healds under expert instructors.

Bachelor of Science Degree, 27 Months

- Radio-TV Technician including Color TV (12 Months)
- Electronics Technician (12 Months)
- Industrial Electronics Technician (12 Months)
- Electronics Engineering (B.S. Degree)
- Electrical Engineering (B.S. Degree)
- Mechanical Engineering (B.S. Degree)
- Civil Engineering (B.S. Degree)
- Architecture (B.S. Degree)

Heald College ranks **FIRST** West of the Mississippi in "Who's Who in America"

Approved for Veterans
DAY AND EVENING CLASSES
Write for Catalog and Registration Application.
New Term Starting Soon.

Your Name

Address

City

State

ARKAY Offers . . .

FREE Regular 35¢ book "Let's Talk About STEREO." The Complete story of STEREO PHONIC SOUND. No cost or obligation. Available now only from your local dealer

Pure Riee's
**OFFICIAL
ORDER BOOK**
for every TV-Radio
service call

**CONVENIENT!
EASY TO USE!**

Simplify your record-keeping with these convenient triplicate forms. They serve as order form, invoice and office record, with spaces for complete information on every job. Separate listings for receiving tubes, picture tubes, parts, serial numbers, labor and tax charges, etc. 75c a book, \$6.50 for money-saving dust-proof box of 10.

In stock at your distributor

ELECTRONIC PUBLISHING CO. INC.
180 North Wacker Drive Chicago 6, Illinois



Buy intelligently. Spend just \$1.00 to back your hi-fi choice with 50,000 hours of testing, research, and engineering. Bulletin TR114 tells you exactly what, where, why, and how to buy. Minimum outfit, \$200, excels those above \$800.00. Protect yourself from the over-priced, over-advertised, over-rated, under-engineered, marginal-quality. Some un-advertised top notch items available only from manufacturers. No c.o.d.'s please. For clear, concise, complete advice, send \$1.00 to:

SCIENTIFIC RESEARCH ASSOCIATES
726 So. Central Ave. Glendale 4, California

**WILL YOUR REPLACEMENT
Fuse Resistor
BURN OUT AGAIN?**

Not if you use—
**The NEW SENCORE
"FUSE-SAFE"
CIRCUIT TESTER**

*Another
Sencore
Time-
Saver*

Save costly call backs by testing the circuit before replacing fuse, fuse resistor or circuit breaker.



Individual scale for each value fuse resistor — no interpretation, just read in red or green area

- ★ Measures line current and up to 1100 watts of power at 115 volts using line cord and socket.
- ★ Two convenient current ranges — 0 to 2 amps and 0 to 10 amps. Test leads clip in place of fuse or fuse resistor.
- ★ 5 ohm, 10 watt resistor prevents TV circuit damage and simulates operating conditions.

As Recommended by Leading Manufacturers

\$8.95
DEALER NET
MODEL PS-3
AC-DC or both as needed for Fuse Resistor Circuits

Mfg by **SERVICE**
INSTRUMENTS CORP.
171 OFFICIAL RD., ADDISON, ILL.

Cut out this ad now for further information

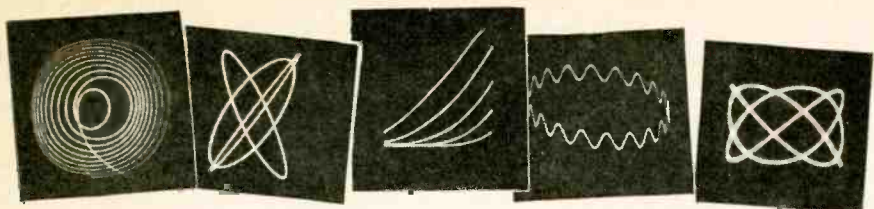

Do you get this message?

The scope is a wonderful instrument—with so much to say to the man who understands. These unusual patterns are only a few of the hundreds illustrated and explained to you by engineer Alfred Haas in the latest Gernsback book—*Oscilloscope Techniques*.

He shows you how to understand oscilloscope wave forms—master scope operation—put it to new uses—**increase your efficiency.** Every alert and ambitious technician, engineer and experimenter will want this new book.

HOW TO GET THIS \$4.60 BOOK FOR ONLY \$3.35

This brand-new book in a new beautifully designed hard-cover edition is advertised nationally for \$4.60. But through the G/L TECHNICIANS' BOOK CLUB you can get it and others equally valuable for only \$3.35.

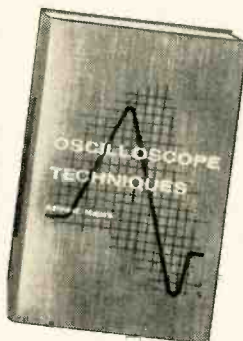

OSCILLOSCOPE TECHNIQUES

By Alfred Haas
224 pages. Deluxe hard cover. Hundreds of waveform photos.

List price \$4.60

THE G/L TECHNICIANS' BOOK CLUB

has helped thousands of service technicians everywhere

- Learn More
- Do Faster Servicing
- Earn More Money
- Save money on the books they need to get ahead.

Here's how it can help you! This unique club offers deluxe hard-cover editions of today's best practical servicing and theory books by well known authors AT A DISCOUNT OF 27%! Through mass printing and

direct distribution we can offer you these \$4.60 books AT THE WHOLESALE PRICE OF \$3.35—and we pay the postage!

How the Club Works

- To enroll, select the book you want on the coupon below. SEND NO MONEY. Please select only one book! The one you choose will be sent to you on a No-Risk 10-day inspection plan.
- If you like the book keep it and send us your remittance. If you don't

just send it back.

- A new book is published every three months—you receive your personal copy on the same No-Risk inspection plan as soon as it comes off the press.
- Keep only the books you want—pay only for those you keep.
- You agree to take a minimum of only 4 books—over the whole enrollment period. You may cancel anytime after that. No time limit—no contract to sign.

IF YOU PREFER—

select any one of these previously published books instead of *OSCILLOSCOPE TECHNIQUES*

TV and Radio Tube Troubles—By Sol Heller. New symptom analysis technique shows you how to track down tube troubles in minutes.

Rapid TV Repair—By G. Warren Heath. How to get to the heart of tough TV troubles in minutes. Lists hundreds of troubles alphabetically—gives causes, symptoms, cures. No theory—all practical data. Time-saving trouble-shooting charts.

Servicing Color TV—By Robert G. Middleton. Answers all your questions about chroma circuits, matrix testing, the flyback system, test equipment and much more. Helpful trouble-shooting charts.

TV—It's a Cinch—By E. Aisberg. All about TV theory from studio to picture tube. Write-

ten in breezy conversational style illustrated with hundreds of specially-drawn humorous sketches.

Servicing Record Changers—By Harry Mileaf. Make extra money servicing changers.

The V.T.V.M.—By Rhys Samuel. Get more out of this versatile instrument.

Sweep and Marker Generators for Television and Radio—By Robert G. Middleton. A must for television servicing.

Probes—By Bruno Zucconi and Martin Clifford. How to use probes for better servicing with today's complex test instruments.

The Oscilloscope—By George Zwick. Are you getting full use of your 'scope? This book shows you how!

**SEND NO MONEY!
MAIL THIS COUPON TODAY!**

You have nothing to lose — everything to gain! Examine the books at our risk.

Stay ahead in servicing—keep up with new techniques, circuits, devices. New books on timely topics now in preparation.

SEND IN THIS COUPON TODAY

GERNSBACK LIBRARY, INC., Dept. 98C
154 West 14th St., New York 11, N.Y.

Enroll me in the G/L TECHNICIANS' BOOK CLUB. Begin my membership with the book checked below. Please check one only.

- | | |
|---|--|
| <input type="checkbox"/> OSCILLOSCOPE TECHNIQUES | <input type="checkbox"/> THE V.T.V.M. |
| <input type="checkbox"/> TV and RADIO TUBE TROUBLES | <input type="checkbox"/> SWEEP AND MARKER GENERATORS |
| <input type="checkbox"/> RAPID TV REPAIR | <input type="checkbox"/> SERVICING RECORD CHANGERS |
| <input type="checkbox"/> SERVICING COLOR TV | <input type="checkbox"/> PROBES |
| <input type="checkbox"/> TV—IT'S A CINCH | <input type="checkbox"/> THE OSCILLOSCOPE |

Name..... please print

Street.....

City..... Zone..... State.....

Books



TRANSISTOR CIRCUITS, Sylvania Electric Products, Inc., 1100 Main St., Buffalo 9, N. Y. 6 x 9 inches, 53 pages, 35c.

This is the latest booklet for transistor hobbyists and experimenters. A glance through the 36 circuits shows a wide variety of useful instruments. There is a burglar alarm, metronome, high- and low-voltage supplies, blinker, logic circuit and many others. For each circuit, there is a schematic, parts list and details for construction and operation.

The first few pages tell how semi-conductors amplify. The remainder of the booklet is strictly practical and easy to understand.—IQ

CARE AND REPAIR OF HI-FI, by Leonard Feldman. Cowan Publishing Corp., 300 W. 43 St., New York, 30. N. Y. 5½ x 8½ inches, 156 pages, \$2.50.

Directed at the experienced service technician, this book dwells on those points which he is less likely to have worked with in straight radio and TV servicing. He is alerted as to the possibility of and reasons for dc filament supplies in preamplifiers early in the book, for example. Other chapters deal with tone controls, loudness controls, equalization, cathode followers and phase inverters, as well as a number of chapters on such more familiar subjects as power amplifiers and power output stages (which are different, however, in hi-fi amplifiers!). Numerous illustrations and schematics.

AUDIO DESIGN, by H. A. Hartley. Gernsback Library, Inc., 154 W. 14 St., New York 11, N. Y. 5½ x 8½ inches, 224 pages, \$2.90.

This author is well qualified in the hi-fi field. He has pioneered and specialized for over 30 years in quality reproduction, and claims to have originated the term "hi fi" in 1927. Here Mr. Hartley offers an excellent and most readable guide book for hi-fi enthusiasts and music lovers. Especially helpful are the many tables and diagrams which simplify design work and eliminate the need for mathematics.

The book begins with a chapter on basic requirements, the best position for a speaker, ear response, etc. Then it shows how to design the final stage from a knowledge of the required power output. Design proceeds stage by stage back to the sound source to assure ample drive and minimum distortion. Separate chapters are devoted to transformers, filters, power supplies, speakers and measurements.

CRYSTAL CONTROLLED CONVERTERS

POLICE • FIRE • COMMERCIAL



- ✓ Precision—Stability
- ✓ Sensitivity
- ✓ Easy Installation

\$32.50

• A compact converter supplied with commercial tolerance crystals, self contained automatic noise limiter. Also models with squelch. Ideal for mobile or home use.

TUNERS

Enjoy FM Programs While You Drive.

- FM BROADCAST
- 30-50 MC
- 108-176 MC

from **\$22.50**

WRITE FOR LITERATURE

KUHN ELECTRONICS

20 GLENWOOD CINCINNATI 17, OHIO

ORDER by MAIL and SAVE! TV PICTURE TUBES

10BP4	\$ 7.95	17BP4	\$10.95	21AMP4	\$19.95
12LP4	8.95	17CP4	17.00	21ATP4	20.95
14B/CP4	9.95	17GP4	17.60	21AUP4	20.95
16DP4	14.95	17HP4	13.60	21EP4	14.95
16EP4	15.90	17LP4	13.60	21FP4	15.95
16GP4	15.90	17QP4	11.95	21WP4	17.30
16KP4	10.95	17TP4	19.30	21YP4	15.95
16LP4	10.95	19AP4	19.30	21ZP4	14.95
16RP4	10.95	20CP4	13.90	24CP4	23.95
16WP4	15.20	20HP4	17.95	24DP4	26.95
16TP4	10.95	21AP4	22.10	27EP4	39.95
17AVP4	15.20	21ALP4	20.95	27RP4	39.95

27" - 6 month guarantee - all others 1 year. Aluminized Tubes \$5.00 more than above prices. These prices are determined to include the return of an acceptable similar tube under vacuum.

ALL PRICES FOR CHICAGO, ILLINOIS. Deposit required, when old tube is not returned, refundable at time of return. 25% required on COD shipments. Old tubes must be returned prepaid. We ship anywhere.

WRITE FOR COMPLETE LIST.

PICTURE TUBE OUTLET

3032 Milwaukee Ave., Chicago 18, Ill.

Dickens 2-2048

Your choice of school is highly important to your career in



INDUSTRIAL ELECTRONICS



RADIO-TELEVISION



ELECTRONICS COMMUNICATIONS

Become an ELECTRICAL ENGINEER or an ENGINEERING TECHNICIAN at

MSOE in Milwaukee

Choose from courses in:

ELECTRICAL ENGINEERING

Bachelor of Science degree in 36 months—Communications or Electrical Power.

ENGINEERING TECHNOLOGY

Associate in Applied Science degree in 18 months—Electronics Communications, Electrical Power, or Computers.

MSOE — located in Milwaukee, one of America's largest industrial centers—is a national leader in electronics instruction—with complete facilities, including the latest laboratory equipment, visual aid theater, amateur radio transmitter —offers 93 subjects in electrical engineering, electronics, radio, television, electrical power, and electricity.

Advisory committee of leading industrialists. Courses approved for veterans. Over 50,000 former students. Excellent placement record. Previous educational, military, and practical experience is evaluated for advanced credit.



QUARTERS BEGIN SEPTEMBER, JANUARY, MARCH, JULY

Choose wisely—your future may depend on it. Mail coupon today!

MILWAUKEE SCHOOL OF ENGINEERING

Dept. RE-958, 1057 N. Milwaukee St. Milwaukee, Wis.

Please send free illustrated career booklet (please print)

I'm interested in..... (Course)
Name..... Age.....
Address.....
City..... State.....
 I am I am not eligible for veterans benefits
(discharge date)

SCHOOL DIRECTORY

1 + 2 x 3 does NOT = 9

Don't be held back by lack of math. Learn math from arithmetic through college-level differential and integral calculus by one correspondence course. No previous college or high school math necessary. Above-average intelligence not needed to master the easy to understand lessons on arithmetic, college algebra, trigonometry, analytic geometry, differential and integral calculus. All that is needed is willingness to work. This course is an excellent review for those who took these subjects long ago. Complete course \$25.00 (no other texts needed) plus few cents postage for mailing lessons to and from school. Start immediately! Work at your rate of speed. Mail check or money order to

MATH A to C 112 No. Fayette St. Alexandria, Va.

Be a "key" man. Learn how to send and receive messages in International Morse code. Communicate with operators around the globe. Learn at home quickly through famous Candler System. Used by best operators. Qualify for Amateur or Commercial License. Write for FREE BOOK.

CANDLER SYSTEM CO.
Dpt. 3-K, Box 9226, Denver 20, Colo. USA

ELECTRONICS ENGINEERING DEGREE IN 27 MONTHS

Prepare for unlimited opportunities in electronics! B.S. degree in 27 months, mathematics, electrical engineering, TV, advanced radio theory and design. Modern labs. Low tuition, earn board. Also Aero., Chemical, Civil, Electrical, Mech. Engineering. B.S. degree in 36 mo. in Math., Chem., Physics. Also prep courses. G.I. appr. 20 bligs., dorms, gym. Enter Sept., Dec., March, June. Catalog. Keeping Pace With Progress.

INDIANA TECHNICAL COLLEGE
1598 E. Washington Boulevard, Fort Wayne 2, Indiana

ELECTRONICS

PREPARE FOR A GOOD JOB!
BROADCAST ENGINEER
RADIO SERVICING AUTOMATION

TELEVISION SERVICING
BLACK & WHITE—COLOR

APPROVED FOR VETERANS AND SURVIVORS OF VETERANS
BUILDING AIR CONDITIONED
SEND FOR FREE LITERATURE

BALTIMORE TECHNICAL INSTITUTE
1425 EUTAW PLACE, BALTIMORE 17, MD.

ENGINEERING DEGREES

E.E.
Option Electronics or Power

Earned through HOME STUDY
Residence Classes Also Available

PACIFIC INTERNATIONAL UNIVERSITY
Colleges of Engineering and of Physics
5719-M, Santa Monica Blvd., Hollywood 38, Calif.

college grads get ahead faster!

... have higher incomes ... advance more rapidly. Grasp your chance for a better life. Share rewards awaiting college men. Important firms visit campus regularly to employ Tri-State College graduates. Start any quarter. Approved for Vets.

Bachelor of Science Degree in 27 months

Electrical Engineering with either an Electronics or Power major. Also Mechanical, Civil, Chemical, Aeronautical Engineering in 36 months a B.S. in Business Administration (General Business, Accounting, Motor Transport Management Majors). Superior students faster. More professional class hours. Small classes. Enrollment limited. Beautiful campus. Well-equipped labs. Prep courses. Enter Sept., Jan., March, June. Earnest, capable students (whose time and budget require accelerated courses and modest costs) are invited to write Jean McCarthy, Director of Admissions, for Catalog and "Your Career in Engineering and Commerce."

TRI-STATE COLLEGE
2498 College Avenue, Angola, Indiana

GET INTO ELECTRONICS

V.T.I. training leads to success as technicians, field engineers, specialists in communications, guided missiles, computers, radar and automation. Basic and advanced courses in theory and laboratory. Assoc. degree in electronics in 20 mos. B.S. in electronic engineering obtainable. ECPD accredited. G.I. approved. Graduates in all branches of electronics with major companies. Start September, February. Dorms, campus. High School graduate or equivalent. Catalog.

VALPARAISO TECHNICAL INSTITUTE
Dept. C Valparaiso, Indiana

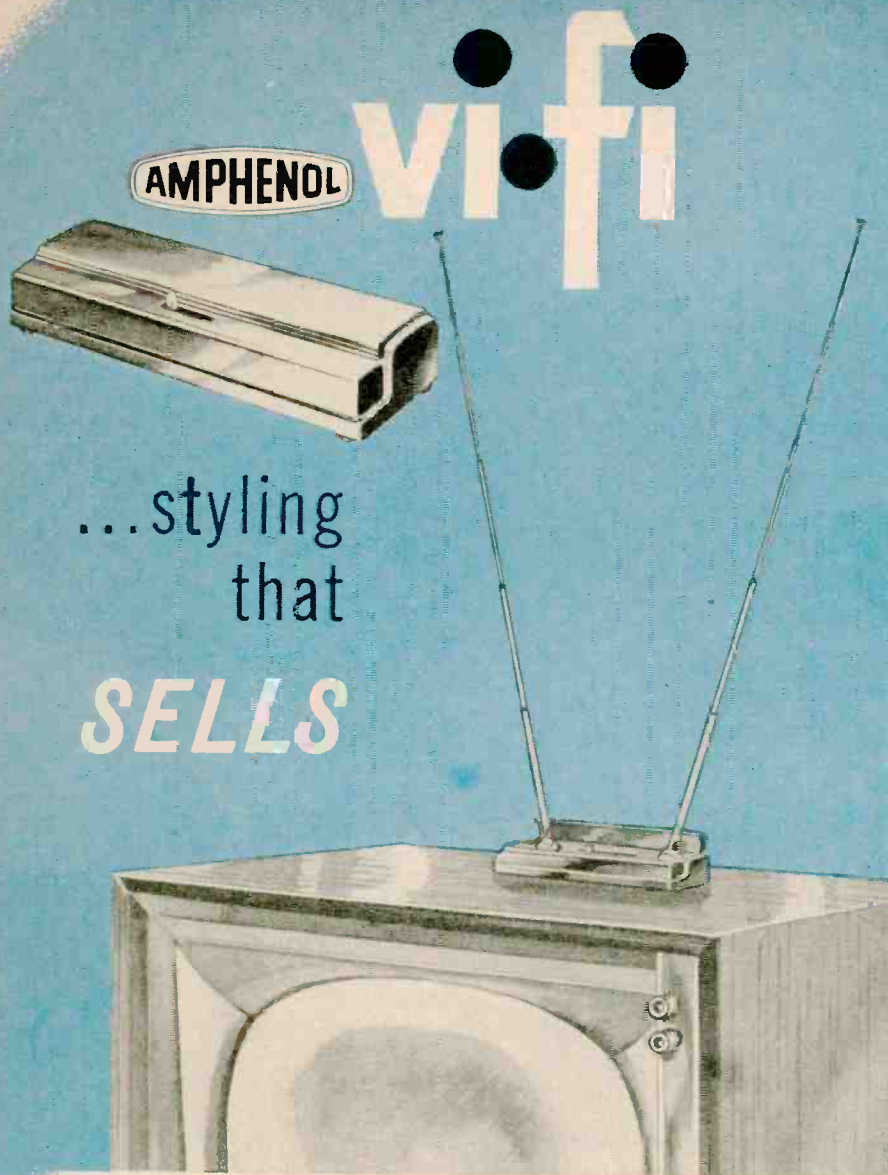

...styling
that
SELLS

AMPHENOL's Vi-Fi indoor tv antenna appeals to Mrs. Consumer because of appearance—Vi-Fi is the *only* indoor antenna that matches the modern, slim lines of the new tv sets with equally modern slenderline styling.

...and performance that convinces the Mister! Vi-Fi offers optimum operating efficiency. Its matching transformer coupling corrects the usual mis-match between set and antenna. Variable-value inductors allow sharp VHF tuning.

Vi-Fi antennas, for VHF and VHF/UHF, are available in four beautiful colors. Buy Vi-Fi—its appearance and performance sell the whole family!

AMPHENOL ELECTRONICS CORPORATION

chicago 50, illinois



BOOKS (Continued)

In the final chapter Mr. Hartley tells his personal ideas on hi fi and distinguishes between the needs of the "audiophile" and the "music lover." It is my personal opinion that both groups can greatly benefit from this informative book.—IQ

THE ENCYCLOPAEDIA OF RADIO AND TELEVISION. J. H. Reyner, Technical Consultant, Philosophical Library, Inc., 15 E. 40 St., New York 16, N.Y. Second edition. 5½ x 9 inches, 736 pages. \$12.

From "A (Abbreviation for ampere)" to "Zoom lens," this standard British work contains more than 3,000 entries with many diagrams, treating the main aspects of modern radio and television engineering. The book is the work of 13 English authorities and is essentially similar to the 1950 edition except for a 100-entry appendix on recent developments, dealing with such subjects as FM and color television.—DL

LOW POWER TELECASTING, by Harold E. Ennes. Howard W. Sams & Co., 2201 E. 46th St., Indianapolis 5, Ind. 6 x 9 inches, 106 pages. \$2.95.

Written for station owners and operating personnel, but also of general interest to the technically minded, this book details the new phenomenon of small-town low-powered installations, with chapters on antennas and propagation, transmitters, the Vidicon camera and associated equipment and general station construction.

ELECTRONIC PUZZLES AND GAMES, by Matthew Mandl. Gernsback Library, Inc. 154 W. 14th St., New York 11, N.Y. 5½ x 8½ inches, 127 pages. \$1.95.

If you like to solder and connect switches, batteries, lamps and buzzers, this book will show you how to make interesting games and puzzles. If you don't know how to solder, this book will tell you how. Games are played with the aid of switches and spinners, with scores and winners indicated by lights. The author gives complete details for making and playing.

Games include jet plane battle, satellite launching, space travel and target competition. Magic number, hidden word and many other puzzles are included. This is an excellent introduction for youngsters into a fascinating field, and it will mean many hours of fun.

TV DISTRIBUTION SYSTEMS AND ANTENNA TECHNIQUES, by Jack Beaver. Howard W. Sams & Co., Inc., Indianapolis 5, Ind. 5½ x 8½ inches, 167 pages. \$2.95.

Beginning with a discussion of antenna fundamentals, installation, phasing and interference problems, the book goes on to passive and then to amplified distribution systems, uhf conversion and television distribution amplifiers and long-run systems. The book closes with a chapter on how to sell distribution systems. END

ADVERTISING INDEX

Radio-Electronics does not assume responsibility for any errors appearing in the index below.

Allied Radio Corp.	22-23, 27	Mosley Electronics Inc.	136
Almo Radio Co.	116	Moss Electronic Distributing Co., Inc.	119-120
Amphenol Electronics Corp.	140	Multicore Sales Corp.	131
Arky Inc.	137	National Radio Institute	3, 19-20
Atlas Sound Corp.	136	National Schools	5
B & K Manufacturing Co.	101	North American Philips Co., Inc. (Norelco)	128
Barry Electronics Corp.	141	Northrop Aeronautical Institute	106
Belden Manufacturing Co.	89	Opportunity Adlers	120
Bell Telephone Labs.	28	Perma-Lower Co.	90
Berkeley Enterprises, Inc.	132	Philco Accessory Division	8
British Industries Corp.	131	Philco Teclrep Division	25
Brooks Radio & Television Corp.	122	Picture Tube Outlet	139
CRS-Hytron	105	Prentice-Hall Inc.	132
Capitol Radio Engineering Institute	93-94	Progressive Edu-Kits Inc.	115
Carston Studios	132	Quality Electronics	141
Castle Television Services Ltd.	118	Quam-Nichols Co.	121
Central Div. of Globe Union	78	Quletrole Co., Inc.	130
Century Electronics Co., Inc.	95, 125	R-Columbia Products Co., Inc.	133
Chicago Standard Transformer Corp.	124	Radiart Corp.	108, 110
Clarostat Manufacturing Co., Inc.	107	RCA Electron Tube Division	Back Cover
Cleveland Institute of Radio Electronics	10-11	RCA Institutes	91
Cornell-Dubilier Electric Corp.	108, 109	RCA (Test Equipment)	112
Coyne Electrical School	13, 126, 133	Radio Shack Corp.	83
Delta Electronics Ltd.	141	Radiola Manufacturing Co.	8
DeRO Electronics	90	Rider (John F.) Inc.	127
Deuschmann (Tob) Corp.	111	Rinehart & Co., Inc.	125, 134
DeVry Technical Institute	7	Rockbar Corp. (Collaro)	24
Dressner	141	Rolin Manufacturing Co.	79
Dynaco, Inc.	135	Sanus (Howard W.) & Co., Inc.	16, 21, 87
Electro-Sonic Labs.	18	Schober Organ Co.	133
Electro-Voice, Inc.	Inside Back Cover	Science & Mechanics	129
Elex, Inc.	134	Scientific Research Associates	137
Electronic Chemical Corp.	126	Seco Manufacturing Co.	21
Electronic Instrument Co. (EICO)	29, 30, 113	Seg Electronics	121
Electronic Measurement Corp. (EMC)	122	Service Instruments Corp.	116, 131, 137
Electronic Publishing Co., Inc.	137	Sonotone Corp.	99
Erie Resistor Corp.	131	Sprayberry Academy of Radio Television	17
E-Z Hook Test Products Co.	130	Stan-Burn Radio & Electronics	134
Garfield (Oliver) Co.	90	Stromberg-Carlson	114
General Cement Manufacturing Co.	14	Supreme Publications	117
Gernsback Library, Inc.	128, 138	Tab	129
Grantham School of Electronics	15	Tarzan (Saries) Inc.	88
Greenwich Book Publishers	132	Telco Electronics Manufacturing Co.	14
Hallmark Electronics	134	Trio Manufacturing Co.	125
Head Engineering College	13	Tung-Sol Electric Co.	6
Heath Co.	62-77	University Loudspeakers Inc.	130
Hudson Specialties Co.	124	Van Nostrand (D.) Co., Inc.	9
Illinois Condenser Co.	126	Western Radio	132
Indiana Technical College	141		
Jensen Industries	116		
Jensen Manufacturing Co.	Inside Front Cover		
Jerrold Electronics Corp.	26		
Key Electronics Co.	132		
Kuhn Electronics	139		
Lafayette Radio	142-143, 144		
Lansing (James B.) Sound, Inc.	16		
Leitron Inc.	118		
Mallory (P.R.) & Co., Inc.	84-85		
McGraw-Hill Book Co., Inc.	97		
McNeal Electric & Equipment Co.	136		
Merit Coil & Transformer Co.	123		

SCHOOL DIRECTORY PAGE 139

Baltimore Technical Institute	
Candler System Co.	
Indiana Technical College	
Math A to C	
Milwaukee School of Engineering	
Pacific International University	
Tri-State College	
Valparaiso Technical Institute	

BRANCH ADVERTISING OFFICES: Chicago: 600 Waukegan Road, Glenview, Ill., GLenview 4-6900. Los Angeles: Ralph W. Harker and Associates, 600 South New Hampshire. Tel. DUnkirk 7-2328. San Francisco: Ralph W. Harker and Associates, 444 Market St. Tel. Garfield 1-2481.

FOREIGN AGENTS: Great Britain: Atlas Publishing and Distributing Co., Ltd., 18 Bride Lane, London E.C. 4. Australia: McGILL'S Agency, Melbourne. France: Brentano's, Paris 2^e. Belgium: Agence et Messageries de la Presse, Brussels. Holland: Trilectron, Heemstede. Greece: International Book & News Agency, Athens. So. Africa: Central News Agency, Ltd., Johannesburg. Capetown. Natal: Universal Book Agency, Johannesburg. India: Broadway News Centre, Dadar, Bombay #14. Pakistan: Paradise Book Stall, Karachi 3. Printed in the United States of America



QUAL-KITS ARE EASIIEST!

And they have the finest features and specs. Fully illustrated step-by-step 28-page manual makes assembly a snap! WRITE FOR FREE CATALOG *Add 10% for Federal Tax.

QUALITY ELECTRONICS
319 Church Street Dept. RE-9 New York 13, N.Y.

TAPE RECORDERS

HI FI COMPONENTS
Tapes—Accessories
UNUSUAL VALUES
Send for Free Catalog

DRESSNER
69-02 RE-174 St.
Flushing 65, N.Y.

MERITAPE
Low Cost, High Quality Recording Tape—in boxes or cans.

ENGINEERING B.S. DEGREE IN 27 MONTHS

Prepare for unlimited opportunities of the Electronic Age!

Earn your B.S. DEGREE IN 27 MONTHS in Aeronautical, Chemical, Civil, Electrical or Mechanical Engineering; in 36 MONTHS in Mathematics, Chemistry, Physics. Intensive, specialized courses. Comprehensive training in electronics, television, advanced radio theory and design, math, nuclear physics and elec. eng. Engineering Science preparatory courses. Low rate. Graduates in demand. Spacious campus; 20 bldgs., dorms, gym, playing field. Earn part of your expenses in Fort Wayne, G.I. approved. Enter Sept., Dec., March, June. Catalog.

INDIANA TECHNICAL COLLEGE
1798 E. Washington Blvd., Fort Wayne 2, Indiana

Please send me free information on B.S. ENGINEERING DEGREE IN 27 MONTHS as checked.

Electronics Chemical Aeronautical
 Civil Mechanical Electrical

B.S. DEGREE IN 36 MO. in: Math. Chem. Physics

Name _____
Address _____

• FINEST QUALITY • LOW IN PRICE

DELTA

INTERMEDIATE SIZE BA-24
BROAD-BAND AMPLIFIER



DB's cost \$\$\$—Don't buy what you can't use!

HERE IS THE INSTALLERS ANSWER FOR SMALL BUILDINGS UP TO 20 OUTLETS

Packed with features found only in amplifiers costing twice as much. Better than 24 DB Gain on both HI and LO Bands. Guaranteed flat for color, low noise, new long-life tubes. With the BA-24 you can quote "right" on that job.

\$29.95

ONLY

Inquiries from Established U.S. and Canadian Distributors Invited

Write for literature and complete information on other low-cost Delta quality products

DELTA ELECTRONICS LTD.
28 Eugene Street
TORONTO 19, CANADA

HQ for the 5 TOP NAMES in
TV & RECEIVING TYPE

TUBES

AT SENSIBLE PRICES!

SALE!	TUBE SPECIALS	SALE!
2C26 \$.15 211	75 958	.25
2X2 .30 274B	40 1201	.25
ELCSB 7.30 532A	25 1203A	.25
6CG6 .20 724B	30 1616	.45
6G6 .25 826	50 1626	.10
6G6 .25 830B	30 1629	.30
10Y .20 838	2.50 1655	.75
12AG .50 863	20 9001	.50
CRP72 .30 884	1.25 9003	1.20
VR92 .20 954	15 9004	.20
VR150 .35 957	20 9006	.15

WRITE FOR LATEST TUBE CATALOG FREE!
Receiving, transmitting, special purpose tubes, diodes, transistors, etc.

2-COLOR TUBE CARTONS

Keeps your tube stock neat. New safety partition prevents tube breakage. Distinctively lithographed in glossy red and black. The most distinctive tube carton available today. Minimum quantities 100 of any one size. Write for case lot prices. Packed 1000 to case. F.O.B. N.Y.C.

Size	For Tube	Per 100
Miniature	6AU6, etc.	\$1.00
GT	6SN7, etc.	1.25
Large GT	183, etc.	1.50
Large G	5U4G, etc.	2.00



WHITE GLOSSY BOXES

Completely blank. No printing or color. Otherwise same as above. Same high quality, same low prices. Specify "WHITE" when ordering. When color is not stated, 2 color cartons will be shipped.

EQUIPMENT & COMPONENT SPECIALS

- **JENNINGS VACUUM-VARIABLE CAPACITORS:** Type UCSX—Range Approx. 20 to 700 MMFD @ 10 Kv. Complete w/ MTG—Brkts and Gear Drive and motor. Once in a lifetime buy at low price of only \$36.95
- **6 and 12 Volt (operates from either) Input Carter Duovolt Dynamotors:** Medium Size Unit Puts out 400 Volts @ 375 Ma. \$15.95 Large Size Unit Puts out 620 Volts @ 280 Ma. \$19.95 All Units are brand new, genuine Carter Dynamotors in original packages.
- **New! Mobile Western Electric Single Head Set and Microphone** (The one the long distance operators use) This latest model tiny microphone is attached to single earphone which allows complete freedom (no hands). Comes complete with leather headband. A gem of a buy at \$5.00 ea. 2 for \$10.00
- **Glas-Line Non-Metallic Guy Line** (eliminates need for glass "break-up" insulators) per 100 ft. @ \$2.89; 600 ft. reel @ \$17.34
- **Tobe Oil Capacitors:** 10 MFD @ 600 VDC (working) Brand New Original Boxed Price \$1.00
- **Kilowatt Antenna Change-over Relay.** Specs: 115 Volts AC 60 CPS Coil. Contacts: Double-Pole, double-throw with all ceramic insulation—compact, quiet operation. Special \$3.95
- **6 Henry—500 MA. Chokes—26 OHMS D.C. Resistance.** New—Open Frame. Grey-Commercial Finish \$3.95 (3 for \$9)
- **Cornell-Dubilier Heavy-Duty 12-Volt Power Supply.** C.D. Model No. 3414 Heavy-Duty 300 Volts D.C. Output at 335 MA. Vibrator Supply Units are made with the finest of components and best construction for long trouble-free use. All units are brand new, packed in original cartons. Units come complete with two CK-1006 Rectifier Tubes and C.D. Vibrator Type 12VF10. Input: 12.6 VDCS. Output: 300 Volts D.C. at 335 Milliampers. Size: 8 1/2" High x 13 1/4" Wide x 7 1/4" Deep. Weight: 28 lbs. Sale Price...\$19.50

Scintillation Counter Gammascint Model 1002

Self-contained portable Scintillation type Gamma-Ray Detector designed for prospecting, radiation monitoring, etc. Contains a nine stage photo multiplier tube coupled to Gamma sensitive plastic phosphor which makes this instrument a real buy. Regular Price \$245.00 complete with headphones, leather strap, batteries, ready-to-operate. Sale Price \$49.95

Send 25¢ for New 1958 Green Sheet, listing hundreds of equipment and component specials. All shipments F.O.B. Our Warehouse. Rated firms (Dun & Brad. current F.3 or better) Net 10 Days. 10 day guar. price of mds. only. All merchandise guaranteed.

HOW TO ORDER: Send full remittance and save C.O.D. collection fee—Include sufficient money for postage—We refund unused amount—If you desire shipment C.O.D., include 25% deposit—Send cash by registered mail. Subject to price variation and stock depletion. No C.O.D.'s on tube cartons. Specify Exact Method of Shipment you Desire. (Give name of truckline.)

Open Monday to Saturday—Come in and Browse—We are near Prince St./BMT Station—Spring St./IRT Sta.

BARRY ELECTRONICS CORP.

512 Broadway, Dept. RE-9, N.Y. 12, N.Y.
Phone: WALKER 5-7000

KT-500
IN KIT
FORM
74.50

New! Years Ahead!

LAFAYETTE STEREO TUNER KIT

ONLY
\$7.45
DOWN
7.00 MONTHLY

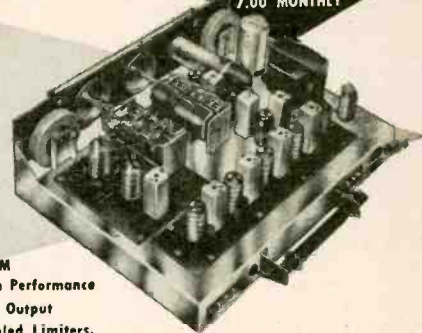

Use it as a Binaural-Stereophonic
FM-AM tuner

Use it as a Dual-Monaural
FM-AM tuner

Use it as a straight Monaural
FM or AM tuner

THE MOST FLEXIBLE TUNER EVER DESIGNED

- Multiflex Output for New Stereo FM
- 10KC Whistle Filter • Pre-aligned IF's • Tuned Cascade FM
- 11 Tubes (including 4 dual-purpose) + Tuning Eye + Selenium rectifier Provide 17 Tube Performance
- Separately Tuned FM and AM Sections • 12 Tuned Circuits • Dual Cathode Follower Output
- Armstrong Circuit with FM/AFC and AFC Defeat • Dual Double-Tuned Transformer Coupled Limiters.

More than a year of research, planning and engineering went into the making of the Lafayette Stereo Tuner. Its unique flexibility permits the reception of binaural broadcasting (simultaneous transmission on both FM and AM), the independent operation of both the FM and AM sections at the same time, and the ordinary reception of either FM or AM. The AM and FM sections are separately tuned, each with a separate 3-gang tuning condenser, separate flywheel tuning and separate volume control for proper balancing when used for binaural programs. Simplified accurate knife-edge tuning is provided by magic eye which operates independently on FM and AM. Automatic frequency control "locks in" FM signal permanently. Aside from its unique flexibility, this is, above all else, a quality high-fidelity tuner incorporating features found exclusively in the highest priced tuners.

FM specifications include grounded-grid triode low noise front end with triode mixer, double-tuned dual limiters with Foster-Seeley discriminator, less than 1% harmonic distortion, frequency response 20-20,000 cps \pm 1/2 db, full 200 kc bandwidth and sensitivity of 2 microvolts for 30 db quieting with full limiting at one microvolt. AM specifications include 3 stages of AVC, 10 kc whistle filter,

built-in ferrite loop antenna, less than 1% harmonic distortion, sensitivity of 5 microvolts, 8-kc bandwidth and frequency response 20-5000 cps \pm 3 db.

The 5 controls of the KT-500 are FM Volume, AM Volume, FM Tuning, AM Tuning and 5-position Function Selector Switch. Tastefully styled with gold-brass escutcheon having dark maroon background plus matching maroon knobs with gold inserts. The Lafayette Stereo Tuner was designed with the builder in mind. Two separate printed circuit boards make construction and wiring simple, even for such a complex unit. Complete kit includes all parts and metal cover, a step-by-step instruction manual, schematic and pictorial diagrams. Size is 13 3/4" W x 10 5/8" D x 4 1/2" H. Shpg. wt., 22 lbs.

The new Lafayette Model KT-500 Stereo FM-AM Tuner is a companion piece to the Models KT-300 Audio Control Center Kit and KT-400 70-watt Basic Amplifier Kit and the "Triumvirate" of these 3 units form the heart of a top quality stereo hi-fi system.

KT-500 Net **74.50**

LT-50 Same as above, completely factory wired and tested Net **124.50**

NEW! LAFAYETTE STEREO/MONAUROAL BASIC POWER AMPLIFIER KIT

- 36-WATT STEREO AMPLIFIER - 18-WATTS EACH CHANNEL
- FOR OPTIONAL USE AS 36-WATT MONAUROAL AMPLIFIER
- EMPLOYS 4 NEW PREMIUM-TYPE 7189 OUTPUT TUBES
- 2 PRINTED CIRCUIT BOARDS FOR NEAT, SIMPLIFIED WIRING
- RESPONSE BETTER THAN 35-30,000 CPS \pm 1/2 DB AT 18 WATTS
- LESS THAN 1% HARMONIC OR INTERMODULATION DISTORTION

A superbly-performing basic stereo amplifier, in easy-to-build kit form to save you lots of money and let you get into stereo now at minimum expensel Dual inputs are provided, each with individual volume control, and the unit may be used with a stereo preamplifier, for 2-18 watt stereo channels or, at the flick of a switch, as a fine 36-watt monaural amplifier — or, if desired, it may be used as 2 separate monaural 18-watt amplifiers! CONTROLS include 2 input volume controls, channel Reverse switch (AB-BA), Monaural-Stereo switch. DUAL OUTPUT IMPEDANCES are: 4, 8, 16 and 32 ohms (permitting parallel (monaural) operation of 2 speaker systems of up to 16 ohms. INPUT SENSITIVITY is 0.45 volts per channel for full output. TUBES are 2-6AN8, 4-7189; GZ-34 rectifier. SIZE 9-3/16" d (10-9/16" with controls) x 5 1/4" h x 13 1/4" w. Supplied complete with perforated metal cage, all necessary parts and detailed instructions. Shpg. wt., 22 lbs.

KT-310 Stereo Power Amplifier Kit Net **47.50**



KT-310

ONLY 4.75 DOWN
5.00 MONTHLY

47.50

LAFAYETTE MASTER AUDIO CONTROL CENTER

with BINAURAL CHANNEL AND DUAL VOLUME CONTROL.

- Self-Powered • DC On All Filaments • 24 Positions of Equalization
- Tape Head Input, High Impedance • Dual Cathode Follower Output Stages

This is not only the finest hi-fi preamp characterized by unmatched features, but it has been functionally designed to keep pace with the conversion of your present hi-fi system to binaural (Stereophonic) sound. Incorporates an extra channel and dual volume control for binaural reproduction. Features include DC on all tube filaments, negative feedback in every stage, dual cathode follower output stages and latest printed circuit construction. Less than 0.09% IM distortion and less than 0.07 harmonic distortion at 1V. Hum and noise level better than 80 db below 3V. Uniformly flat frequency response over entire audible spectrum. 7 inputs for every type of phono, tuner or tape. Tasteful styling, brilliantly executed. Size 12 3/4 x 9 1/2 x 3 3/4". Shpg. wt., 10 1/2 lbs.

KT-300—Lafayette Master Audio Control Kit Complete with cage and detailed assembly instructions. Net **39.50**

LT-30—Same as above completely wired and tested with cage and instruction manual.

Net **59.50**

DELUXE 70 WATT BASIC AMPLIFIER

- Conservatively Rated At 70 Watts • Inverse Feedback • Variable Damping
- Metered Balance And Bias Adjust Controls • Available In Kit and Wired Form

Here's ultra-stability in a 70 watt basic power amplifier employing highest quality components conservatively rated to insure performance and long life. Features matched pair KT 88's and wire range linear Chicago output transformer, variable damping control, meter for bias and balance and gold finish chassis. Frequency response 10-100,000 cps \pm 1db. Hum and noise 90 db below full output. IM distortion less than 1 1/2% at 70 watts, less than 0.3% below 30 watts. Harmonic distortion less than 2% at 70 watts from 20 to 20,000 cps \pm 1 db. Output impedance 4, 8 and 16 ohms. Handsome decorative cage perforated for proper ventilation. Size 14 1/2 x 10 x 7 3/8" including cage and knobs. Shpg. wt., 40 lbs.

KT-400—Lafayette 70 watt Deluxe Basic Amplifier Kit complete with cage and detailed assembly instructions. Net **69.50**

LA-70—Same as above completely wired and tested with cage and instruction manual.

Net **94.50**

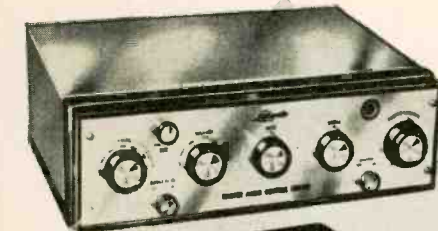

KT-300
IN KIT
FORM
39.50



KT-400
IN KIT
FORM
69.50

ONLY 6.95
DOWN
7.00 MONTHLY

LAFAYETTE RADIO

DEPT J1

165-08 Liberty Ave. JAMAICA 33; N. Y. Write for FREE Bargain Packed Catalog!
PLEASE INCLUDE POSTAGE WITH ORDER

100 SIXTH AVE., NEW YORK, N. Y.
BOSTON, MASS., 110 Federal St.
PLAINFIELD, N. J., 139 West 2nd St.
NEWARK, N. J., 24 Central Ave.
BRONX, N. Y., 542 E. Fordham Rd.

NEW! LAFAYETTE "STEREO" HI-FI PHONO MUSIC SYSTEM

AN IDEAL QUALITY SYSTEM FOR LISTENING
TO THE NEW HIGH-REALISM STEREO SOUND!
For Stereo & Monaural Reproduction



LA-90



RC121/11



SK-58



GE GC-7



CAB-16

COMPONENTS	
Lafayette LA-90 28-Watt Stereo Amplifier	72.50
Garrard RC121/11 Changer	41.65
Lafayette PK-111 Wood Base	3.95
GE GC-7 Stereo Magnetic Cartridge	23.47
2-Lafayette SK-58 Coaxial 12" Speakers	59.00
Total Reg. Price	200.57

ONLY 16.75 DOWN — 12.00 MONTHLY

A superb phono music system brought to you by Lafayette to help you get started in stereo. Heart of the system is the new Lafayette LA-90 with 14 watts per channel and with all the inputs necessary for a complete stereo control center. Other fine components of the system are the famous new Garrard RC121/11 4-speed automatic record changer ready to accept stereo cartridges, the Lafayette PK-111 wood base for changer, of fine selected woods; the new GE GC-7 stereo/monaural variable reluctance cartridge with 0.7 mil genuine GE diamond stylus; and 2 of the unbeatable, for performance-value, Lafayette SK-58 12" coaxial speakers with built-in crossover network and brilliance level control. Supplied complete with cables, connectors, and easy-to-install instructions. Shpg. wt., 66 lbs.

- HF-374 Stereo Phono System, with mahogany or blonde wood changer base (please specify) Net **167.50**
- HF-375 Same as HF-374 but with 2-Lafayette CAB-16 mahogany or walnut or CAB-17 blonde Resonator-type speaker enclosures (specify which) Net **222.50**

LAFAYETTE STEREO FM/AM-PHONO MUSIC SYSTEM

Same as HF-374 above but with new Lafayette stereo Madel LT-99 FM/AM Tuner.

- HF-376 Stereo FM/AM-Phono System Net **237.00**
- HF-377 Same as HF-376 but with 2-Lafayette CAB-16 mahogany or walnut or CAB-17 blonde speaker enclosures Net **292.00**

**YOU PAY ONLY 167.50
SAVE 33.07!**

NEW! LAFAYETTE 30-WATT STEREO AMPLIFIER

Superlative Features and Low Cost make it easy to GO STEREO NOW!



LA-90 72.50

**ONLY 7.25 DOWN
8.00 MONTHLY**

- 28 WATTS MONAURALLY WITH 1 OR 2 SPEAKER SYSTEMS
- 14 WATTS PER STEREO CHANNEL
- SPEAKER PHASING SWITCH
- 3.5 MILLIVOLTS SENSITIVITY FOR TAPE HEAD OR PHONO CARTRIDGE
- 20-20,000 CPS RESPONSE

A new, versatile stereo control center preamplifier-amplifier whose excellent performance and low cost make it easy to start enjoying stereo sound right now! Power output is 14 watts per channel for stereo, or—by placing the Stereo-Monaural Switch in "Monaural" position and connecting the output transformer taps in parallel—28 watts are available to drive a single speaker system monaurally; or—each individual amplifier output may be connected to a separate speaker system for 28-watts total monaural output with the amplifier used as either an electronic crossover, feeding low frequencies to 1 speaker system and highs to the other, or to create a pseudo-stereophonic effect with monaural program material. Response is 20-20,000 cps; distortion is below 1 1/4% at 12 watts; hum is 75 db below full output, either channel; output taps are 8, 16, and 32 ohms (4, 8 or 16 ohms when strapped together); controls include 6-position selector switch (Aux, Ceramic or Crystal, Tuner, LP-RIAA, POP, Tape Head), Balance Channel A, Balance Channel B, Master Level, Treble A and Treble B (dual concentric), Bass A and Bass B (dual concentric), Channel Reverse Switch, Stereo-Monaural Switch, Tape Monitor Switch, Speaker Phasing Switch. Inputs include dual Tuner, Crystal/Ceramic, Mag. Phono, Tape Head, Tape Monitor Output. Tubes are 4-12AX7, 4-EL84; 2-EZ80 Rectifiers. Size is 4-11/16" h x 14-9/16" w x 9-1/4" d. Shpg. wt., 22 lbs.

LAFAYETTE LA-90 Stereo Amplifier Net **72.50**

NEW! LAFAYETTE STEREO MONAURAL FM-AM TUNER

FLEXIBLE DESIGN! LOW BUDGET PRICE! INSTALL STEREO NOW!



LT-99 72.50

**ONLY 7.25 DOWN—
8.00 MONTHLY**

- FM-AM STEREO RECEPTION
- FM OR AM MONAURAL RECEPTION (REQUIRES DECODER)
- FM MULTIPLEX RECEPTION
- FOR SIMULTANEOUS FM & AM LISTENING IN DIFFERENT ROOMS
- 3 MICROVOLTS FM SENSITIVITY
- ARMSTRONG FM CIRCUIT
- AUTOMATIC FREQUENCY CONTROL

An excellent unit with many outstanding features whose low cost and high degree of flexibility combine to make it practicable to enjoy stereo FM/AM broadcasts NOW without fear of obsolescence. The Lafayette LT-99 Stereo Tuner may be used for standard AM or FM (monaural) or for FM-AM stereo listening. Or, you can use it as a 2-channel receiver and feed FM to one room and AM to another at the same time. Outputs are provided for stereo or monaural tape recording directly off the air. Styling is modern and designed to please the style-conscious modern young homemaker.

Circuitry is of the Armstrong FM type, with limiter and discriminator; sensitivity is 3 microvolts (on FM) for 20 db quieting, 75 microvolts loop sensitivity on AM; frequency response is, for FM, 20-20,000 cps ± 1 db, and for AM 20-5,000 cps ± 2 db; output voltages are: FM—2 1/2 volts for 100% modulation, AM—1 volt average. Output jacks include AM-FM Monaural, AM Stereo, AM Tape Recording, FM Tape/Multiplex. Controls include Stereo-Monaural switch, Selector Switch (AM, FM-AFC, FM, Off), AM Tuning, FM Tuning, Multiplex-Tape switch. Built-in FM and AM antennas. Tubes are 6BE6, 2-6BA6, 6UB, 12AT7, 6AU6, 6AL5; diode AM detector, selenium rectifier. For 105-120 volts, 50/60 cps AC. Size 8-1/2" d x 13-5/16" x 4-1/4" h. Shpg. wt., 16 1/2 lbs.

LAFAYETTE LT-99 Stereo Tuner Net **72.50**

Lafayette Radio

165-08 LIBERTY AVE.
JAMAICA 33, N. Y.

Dept. JI

NEW YORK, N. Y.
100 6th Ave.
WOrth 6-5300

BOSTON, MASS.
110 Federal St.
Hubbard 2-7850

BRONX, N. Y.
542 E. Fordham Rd.
*Fordham 7-8813

NEWARK, N. J.
24 Central Ave.
Market 2-1661

PLAINFIELD, N. J.
139 W. 2nd St.
Plainfield 6-4718

PLEASE INCLUDE POSTAGE WITH ORDER



LAFAYETTE'S 1959 CATALOG

"Everything in Electronics"

260 GIANT-SIZED PAGES

Our 38th Year

**The Complete Catalog Featuring
"The Best Buys In The Business"**

FOR THE NEWEST AND FINEST IN
STEREOPHONIC HI-FI EQUIPMENT AND SYSTEMS

- TAPE RECORDERS ● PUBLIC ADDRESS SYSTEMS
- AMATEUR EQUIPMENT ● INDUSTRIAL SUPPLIES
- MINIATURE COMPONENTS ● RADIO & TV TUBES AND PARTS
- EXCLUSIVE LAFAYETTE TRANSISTOR & HI-FI KITS

Send for Lafayette's 1959 Catalog — the most complete, up-to-the-minute electronic supply catalog crammed full of everything in electronics at our customary down-to-earth money-saving prices.

CONTAINS HUNDREDS OF EXCLUSIVE LAFAYETTE ITEMS NOT AVAILABLE IN ANY OTHER CATALOG OR FROM ANY OTHER SOURCE — SEND FOR YOUR COPY NOW!

A "must" for the economy-minded hi-fi enthusiast, experimenter, hobbyist, engineer, technician, student, serviceman and dealer.

Leaders in Hi-Fi

The most complete selection and largest stocks of hi-fi components and systems—available for immediate delivery at the lowest possible prices. Save even more on Lafayette endorsed "best-buy" complete systems.

EASY PAY TERMS Available on orders over \$45—
Only 10% down—Up to 18 months to pay

NEW!

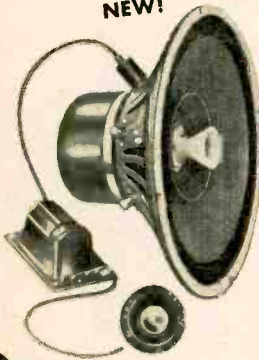

LAFAYETTE-GOODMANS 12" 3-WAY SPEAKER

- 30 WATTS
- FREQUENCY RESPONSE
30-20,000 CPS
- PLUG-IN 12 DB/OCTAVE
CROSSOVER NETWORK
WITH LEVEL CONTROL

Custom-built by Goodmans of England with 1 3/4 lb. Alcomax 3 Magnet. Features axially mounted, free-edged wide range woofer, stiff-coned mid-range radiator and compression-driver tweeter.

SK-110 Net 47.50
Two for Stereo Net 89.00

NEW!



Lafayette TRANSCRIPTION PLAYER WITH 3 LB. 12" ALUMINUM TURNTABLE

Professional 4-speed player ideally suited for stereo. Has magnetic eddy-current brake permitting $\pm 10\%$ speed variation. Amazingly low priced! Shpg. wt., 14 lbs.

PK-240 Net 37.50

NEW!



STEREO BALANCE METER

Dual audio output level indicator with two meters, for comparing audio levels. Ideal for balancing hi-fi stereo systems.

TM-40 Net 8.95

FREE

CUT
OUT
AND
PASTE
ON
POST
CARD

LAFAYETTE RADIO, Dept. JJ
P.O. Box 511, Jamaica 31, N.Y.

SEND FOR THE WORLD'S LEADING ELECTRONICS,
RADIO, T.V., INDUSTRIAL, AND HI-FI GUIDE

Send FREE LAFAYETTE Catalog 590

Name

Address

City..... Zone.... State.....

JAMAICA, N. Y.
165-08 Liberty Ave.
AXtel 1-7000

NEW YORK, N. Y.
100 6th Ave.
WOrth 6-5300

BOSTON, MASS.
110 Federal St.
HHubard 2-7850

BRONX, N. Y.
542 E. Fordham Rd.
FOrdham 7-8813

NEWARK, N. J.
24 Central Ave.
MArket 2-1661

PLAINFIELD, N. J.
133 W. 2nd St.
PLainfield 6-4718



NATIONALLY ADVERTISED 4-SPEED AUTOMATIC RECORD CHANGER

Famous brand latest model with new GE GC-7 Magnetic Compatible Stereo Cartridge with diamond stylus. Guaranteed to please or money refunded! Regular 69.50 Value! Shpg. wt., 21 lbs.

PK-251—(less Wood base)
Net 39.50

NEW!



MINIATURE HIGH SENSITIVITY MULTITESTER

20,000 ohms per volt DC and 10,000 ohms per volt AC instrument. Hand-held, weighs only 10 oz! Clear plastic face cover. Has 23 most used ranges selected by single switch. With batteries and leads. Shpg. wt., 1 lb.

AR-660 Net 22.50

STEP. 1. ID TO STEREO... ON A BUDGET



with Stereo's Standard

IF THIS IS YOUR PRESENT or PROPOSED SPEAKER SYSTEM

costing between \$60-\$90

costing between \$90-\$120

costing between \$120-\$140

costing between \$140-\$200

Includes an 8" coaxial speaker such as:
E-V CORONET* (with SP88), Net \$65
E-V BARONET* (with SP88), Net \$74.50
 SP88: Wide range, economical, super-efficient coaxial speaker. Small high-frequency propagator insures fine dispersion.

Includes a two-way separate system such as:
E-V CORONET IA, Net \$102
E-V BARONET III, Net \$111.50
E-V REGAL IA, Net \$103
 or includes a 12" coaxial speaker such as:
E-V MARQUIS* (with SP128), Net \$98
E-V ARISTOCRAT* (with SP128), Net \$107
 SP128: Added efficiency with lower resonance. Extends fundamental low range. Excellent dispersion for widest stereo effects.

Includes three-way speaker such as:
E-V MARQUIS* (with 12TRXB), Net \$129
E-V ARISTOCRAT* (with 12TRXB), Net \$136
 plus a separate high-frequency driver with electrical crossover for still lower distortion. Gives widest spread of vital stereo range to achieve large stereo listening area.

such as the new **E-V REGAL III**
REGAL
 Super-compact, specially designed system with tailored components to give enhanced range and purity of tone, with least loss of efficiency. Does not require high powered amplifier. Net \$147.50

Includes a 16" three-way speaker such as:
E-V EMPIRE* (with 15TRXB), Net \$178
EMPIRE 15TRV9, similar to 12TRXB, but with added bass efficiency from large woofer, and delivering lower bass response.

E-V systems which can be expanded with E-V building blocks whenever your budget permits.

NOTE: All E-V enclosures also available in limed oak or walnut finishes



STEP ONE

You need the totally compatible **E-V STEREO CARTRIDGE**

- * the first stereo cartridge
- * Thousands already in use prove it
- * Plays ALL RECORDS BETTER
- * Unexcelled for stereo; superior even to your present cartridge for monoaural compliance
- * Highest vertical and horizontal for superior tracking, longest record wear
- * Best channel separation over 20 db between channels
- * Flattest response
- * Flat beyond audibility to RIAA curve
- * Hum and rumble far below any magnetic cartridge
- * Two ceramic elements deliver precise RIAA curve with no hum!
- * Exclusive E-V Built-in Vertical Rumble Suppressor allows record changer use for stereo
- * 7-mil replaceable (diamond or sapphire) stylus is the ideal size... gives you better reproduction, longer record wear

Then choose a second amplifier and pre-amplifier. If this is your initial high fidelity system, start with any stereophonic dual amplifier-preamplifier. Play monoaurally until you add a second speaker for stereo.



- The E-V Totally Compatible Stereo Cartridge is the industry's standard. Choose the model to fit your needs:
- MODEL 210—Stereo with 7-mil Diamond Stylus, Net \$19.50
 - MODEL 24DET—Dual Stylus Turnover from 7-mil Diamond Stereo to 3-mil Sapphire Monoaural, Net \$22.50
 - or the E-V Velocity Stereo Cartridge
 - MODEL 21MD—Stereo with 7-mil Diamond Stylus, Net \$19.50
 - MODEL 24MDT—Dual Stylus Turnover from 7-mil Diamond Stereo to 3-mil Sapphire Monoaural, Net \$22.50

STEP TWO

Add-on E-V BARONET*... smallest folded-horn corner enclosure for best musical balance and response ranging from normal bass range, extended two full octaves. Matches the Coronet and other comparable speaker systems. With SP88, Net \$74.50, or BARONET III with SP88 and T358 VHF driver, Net \$111.50



Add-on E-V ARISTOCRAT*... popular folded-horn corner enclosure... compact, economical... delivers most extended bass range for its size. With SP128, Net \$107.00; with 3-way 12TRXB, Net \$136



Add-on E-V MARQUIS*... matching along-the-wall counterpart of the popular Aristocrat. Response down to 40 cps. With SP128, Net \$98.00; with 3-way 12TRXB, Net \$129



Add-on E-V REGAL III... super-compact, specially designed system with tailored components to give enhanced range and purity of tone with least loss of efficiency. Does not require high powered amplifier. Net \$147.50



Add-on E-V EMPIRE*... direct radiator kilpin-licensed low-boy enclosure tailored for use along-the-wall or in corner. Smooth, extended bass response. With Electro-Voice 15TRXB 3-way speaker, Net \$178



Add-on the new E-V CORONET*... true, balanced high fidelity reproduction in extremely small economical space-saving form; only 10 inches of wall space required. Complements Aristocrat, Marquis, Baronet or comparable speaker systems. With SP88 Blotch speaker, response down to 70 cps. Net \$65.00 or add-on CORONET IA with SP88 and REGAL IA, Net \$103



Add-on STEREO IA
 The all-new Electro-Voice speaker system that solves your space problem—saves you money. Where space doesn't permit you to add a second full-range speaker, a Stereo is the answer. It's compact, because the Stereo reproduces only those frequencies needed for stereo. Bass below 300 cps does not contribute to the stereo effect... so bass from both is handled by your preamplifier. Full-range speaker through the accessory XX3 Stereo Control Filter. (Finest E-V mid-bass, treble and high frequency components give smooth response from 300 to 17,000 cps.)



STEREO IA—for systems of normal efficiency, Net \$99.50
XX3 STEREO CONTROL FILTER, Net \$30

Electro-Voice

ELECTRO-VOICE, INC., BUCHANAN, MICHIGAN
 foremost in Electro-Acoustics—Microphone, Phonograph, High Fidelity Loudspeakers and Enclosures, Public Address Speakers, Marine Instruments, E-V Professional Electronic Instruments and Military Material

Systems shown are but a few of the multitude of E-V combinations found in every price class. Ask your dealer or write Electro-Voice for information on the industry's most complete line of high fidelity speakers and enclosures.

Diagnosis... A Long and Healthy Life!

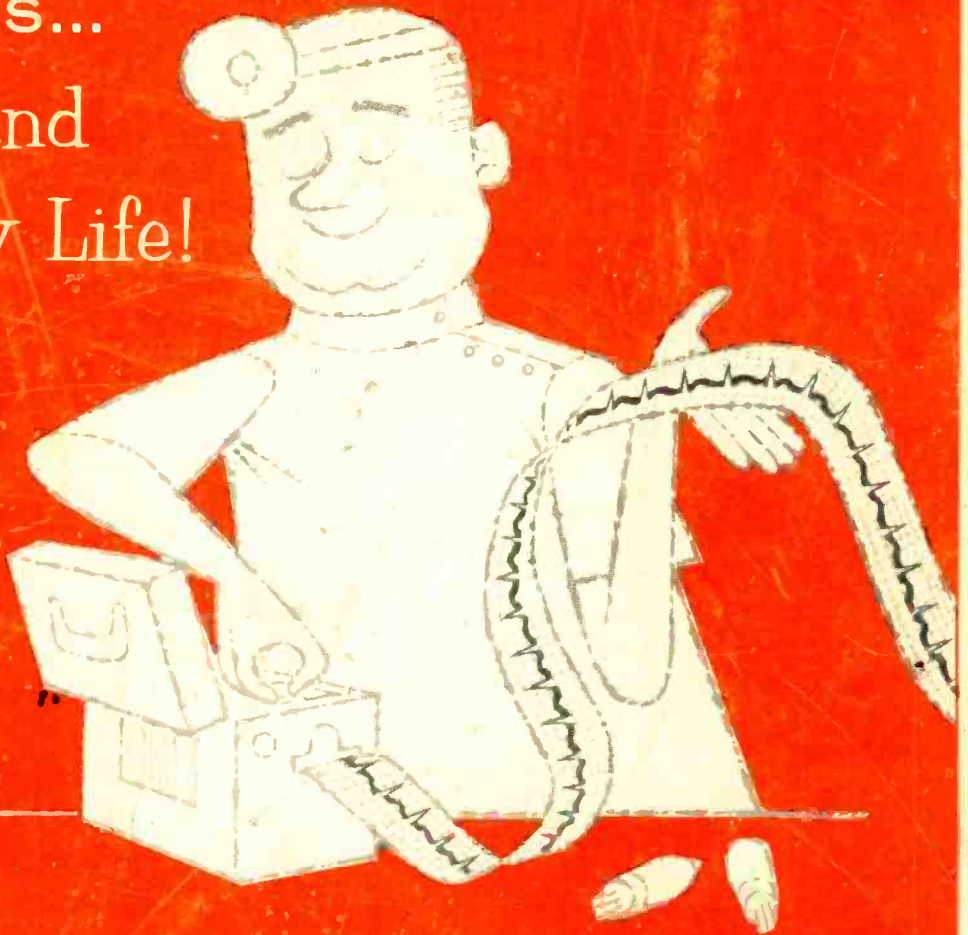

...for the RCA-6AU4-GTA

A "diagnosis" of the RCA-6AU4-GTA shows why it gives top performance for extended hours of operation.

Tube life is increased through improved heat dissipation, achieved with an increased bulb area, new plate shape, and the use of special "clad" plate material. *Early-hour failure is minimized* by elaborate precautions against internal contamination during production. *Borderline tubes are eliminated* through emission tests at extremely low heater voltage, and by aging and life tests at increased plate dissipation. The result is a tube with an unusual ability to resist plate-to-cathode arcing and internal breakdowns.

RCA-6AU4-GTA—*preferred* for TV damper circuits by original equipment designers—is a tube you can rely upon for replacement purposes. Do the same as *all* experienced TV technicians do, always ask your RCA Tube Distributor for RCA tubes!



Speed Up New Simplify Your
Color Troubleshooting With
RCA's Profitable FACT-O-GUIDE
It's chock-full of practical information
and money-saving tips—just what you
need for color-TV servicing.
Available through your RCA Tube
Distributor or send check or
order for \$4.50 payable
to RCA Corporation of America
RCA Commercial Engineering, 415 South 5th St.,
Harrison, New Jersey.



RADIO CORPORATION OF AMERICA

Electron Tube Division

Harrison, N. J.